

FURUNO

OWNER'S MANUAL

COLOR VIDEO SOUNDER

MODEL FCV-662

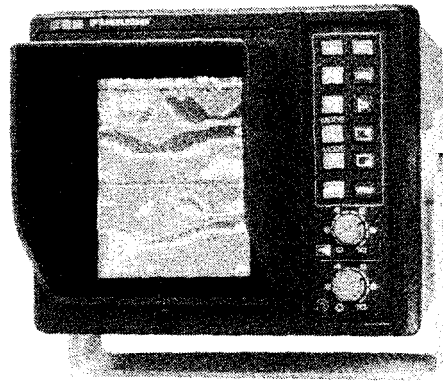

FURUNO ELECTRIC CO., LTD.
NISHINOMIYA, JAPAN

A WORD TO FURUNO FCV-662 OWNERS:

Congratulations on your choice of the FURUNO FCV-662 Color Video Sounder! We are confident that you will enjoy many years of operation with this fine piece of equipment.

For over 30 years Furuno Electric Company has enjoyed an enviable reputation for quality and reliability throughout the world. This dedication to excellence is furthered by our extensive global network of agents and dealers.

The FCV-662 Color Video Sounder is just one of the many Furuno developments in the field of echosounding. The compact, lightweight but rugged unit is easy to install and operate and is suitable for both fresh and salt water applications.

This unit is designed and constructed to give the user many years of trouble-free operation. However, to obtain optimum performance from this unit, you should carefully read and follow the recommended procedures for installation, operation and maintenance. No machine can perform to the utmost of its ability unless it is installed and maintained properly.

We would appreciate feedback from you, the end-user, about whether we are achieving our purposes.

Thank you for considering and purchasing Furuno equipment.

FEATURES

The FCV-662 is a dual-frequency color sounder which has a large variety of functions, all contained in a splash-proof rugged plastic case that is compact to fit almost any size boat.

- 1) Two pages of pictures, which are concurrently plotted and selectively projected onto the screen, double the display capability.

A wide variety of modes (incl. bottom-lock expansion), using potent 150W transceivers (LOW and HIGH frequencies), and graphic data logging are available.

- 2) 8-color presentation (including background) shows the variations in echo intensity, on a 6" diagonal CRT. The dynamic range of the strongest to weakest echoes is very wide on the color video sounder as opposed to the paper recording sounder. Detailed information on fish density and the nature of the bottom are obtainable. For operation in a bright environment, a 6-color presentation mode is available.
- 3) Picture Record/Recall function permits later reference.
- 4) Digital display of navigational data* and water temperature* in addition to water depth ensures finding of best fishing ground and safe navigation.
- 5) Five picture advance speeds for various fishing conditions. Ship's speed dependent advance is also available for presentation with constant horizontal scale regardless of ship's speed.
- 6) Eight Basic Ranges, from 0-15Ft. to 0-1000Ft. Unit of measurement may be changed from Feet to Fathoms, Meters or Passi/Braza.
- 7) Range phasing at every divisions of the scale allows the start of Basic range to be set from zero to a maximum of 1000 Feet, and Automatic Bottom Tracking mode permits unattended range phasing operation.
- 8) Variable Range Marker measures exact target depth.
- 9) Either a Bottom Alarm or a Fish Alarm may be activated. The operator is alerted when bottom echoes or fish echoes between the transducer and the bottom enter into the operator preset alarm zone.
- 10) Three pulselengths from 0.2 to 1.2 msec. for excellent short range and deep range performance.
- 11) Powerful Noise Limiter and Variable Transmission Rate ensure interference-free operation on congested fishing grounds.
- 12) Universal 11-40VDC power supply, drawing less than 25W of power.

* Optional sensor device is required.

TABLE OF CONTENTS

	<u>Page</u>
SPECIFICATIONS	1 to 4
PRINCIPLE OF OPERATION	5
INSTALLATION	6 to 13
TRANSDUCER INSTALLATION	6
Transom Mount	7
Inside-Hull Mount	8
Through-Hull Mount	9
Transducer Preparation and Painting	10
DISPLAY UNIT INSTALLATION	11
Mounting Location	11
Mounting The Display Unit	11
CABLE CONNECTIONS	12
Transducer Cable Connection to Display Unit	12
Power Cable Connection	13
GROUNDING	13
BASIC OPERATION	14 to 21
Introduction	14
Controls	15
Primary and Secondary Functions of Touchpad Keys	15
Power ON/OFF and Brilliance Control	16
Picture Page and Presentation Mode Selection	17
Normal Picture Range Selection	28
Gain Control	20
Picture Advance Speed Selection	20
USEFUL FUNCTIONS	22 to 28
Picture Record/Recall	22
Target Depth Measurement by VRM	22
Noise Limiter	22
Automatic Bottom Tracking	23
Distance-to-go Preset/Distance Run Clear	23
Alarm	24
Temperature Unit Selection	26
Ship's Speed Unit Selection	26
Ship's Position Indication	26
Transmission Rate Selection	26
Color Set Selection for Day and Nighttime Operations	28
INDICATORS	29 to 31
Echo Presentation Modes	29
Graphic Data Logging Mode	30
Utilizing the Water Temperature Indication	31

INTERPRETING THE DISPLAY	32 to 34
Detecting Area	32
Zero Line	33
Fish School Echoes	33
Bottom Echo	33
Surface Noise/Aeration	34
MAINTENANCE	35
General	35
Fuse Replacement	35
Cleaning and Lubrication	35
Maintenance of the Transducer	35
TROUBLESHOOTING	36 to 42
Basic Troubleshooting for the User	36
More Extensive Troubleshooting for the Service Shop	39
Transducer Check	41
Speed/Temperature Sensor Check	41
Serial Communication Interface Check	42
HOW TO CHANGE AND ADJUST INTERNAL SETTINGS	43 to 44
CHANGE OF SPECIFICATIONS	43
ADJUSTMENT OF PICTURE	43
Horizontal Position	43
Vertical Synchronization	43
Horizontal Synchronization	43
Horizontal Size	43
Vertical Size	44
Contrast	44
Focus	44
Vertical Position	44
Color Presentation	44
ADJUSTMENT OF TVG	44
EXPLODED VIEW AND PARTS LIST	45
SCHEMATIC DIAGRAMS	46 to 4
APPENDIX	AP-1 to A1
INSTALLATION OF OPTIONAL DEVICES	AP-1
Mounting Transom Type Transducer using Kick-up Bracket (OP02-29)	AP-1
Mounting Transom Type Sensor	AP-1
Hooking up Ship's Position Data from Position Fixing Equipment	AP-2

SPECIFICATIONS

1. Basic Range

Setting	1	2	3	4	5	6	7	8
Meters	5	10	20	40	80	160	240	320
Feet	15	30	60	120	250	500	750	1000
Fathoms	2.5	5	10	20	40	80	120	160
P/B	4	8	16	32	60	120	180	250

P: Passi B: Braza

Unit is selected with an internal jumper block.

2. Phased Range

Setting		1	2	3	4	5	6	7	8	
S	Meters	1	2	5	10	20	50	50	100	
T	Feet	5	10	20	40	50	100	250	250	
E	Fathoms	1	1	2	5	10	20	40	50	
P	P/B	1	2	5	5	20	40	50	50	
M A X	Meters	320					300			
	Feet	1000								
	Fathoms	160							150	
	P/B	250					240	250		

3. Bottom-Lock Range

Meters	Feet	Fathoms	P/B
2.5	10	1.25	2.5

4. Automatic Bottom Tracking

Bottom tracking feature automatically phases the range so that the bottom is always displayed on the lower portion of the screen as shown right.

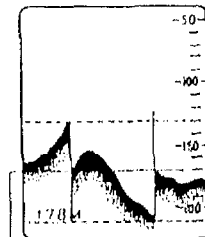

The scrubbed image shifts to 1/4 of the normal picture (the setting of the Range Shift switch is ignored).

5. Display

6" rectangular color CRT

6. Picture Page for Concurrent Plotting and Record/Recall

Two pages, "A" and "B", for concurrent plotting, and another two pages, "a" and "b", for Frozen Picture Record/Recall functions.

7. Presentation Mode (independently selectable for pages A and B.)

"L" : Normal (Low Frequency)

"H" : Normal (High Frequency)

"LB": Normal & Bottom-Lock Expansion, (2/3 & 1/3), (Low Frequency)

"HB": Normal & Bottom-Lock Expansion, (2/3 & 1/3), (High Frequency)

"LH": Normal (Low Frequency) & Normal (High Frequency), (1/2 & 1/2)

"GR": Graphic Data Logging of Water Depth, Water Temperature and Ship's Speed.

8. Picture Advance Speed (independently selectable for pages A and B.)

Setting	0	1	2	3	4
Scan Line/ Transmission	FREEZE	1/6	1/4	1/2	1/1

9. Pulselength and Repetition Rate

Max. Display Range (Basic Range + Phased Range)	Pulse Repetition (pulses/min)				Pulselength (ms)
	Normal		Ship's Speed Dependent		
	min.	max.	2kts	20kts	
0 - 40m	230	610	61	610	0.2
41 - 80m	150	250	25	250	0.2
81 - 240m	130	200	20	200	0.6
241 - 640m	80	110	11	110	1.2

NOTE 1. In the Normal mode, the pulse repetition rate can be changed in 11 steps between the min. and max. values.

2. In the Ship's Speed Dependent mode, the pulse repetition rate varies from the min. to max. value as the ship's speed changes from 2 to 20 knots. Below 2 knots, the min. repetition rate is maintained.

3. When the "LH" presentation mode is selected, the pulse repetition rate is reduced to half of the above value.

10. Transmission Frequency

50kHz and 200kHz

11. Output Power

150W rms

12. Color Presentation

Echoes

Level	Strongest ← → No signal							
	7	6	5	4	3	2	1	0
Nighttime Mode	Reddish Brown	Red	Orange	Yellow	Green	Light Blue	Blue	Deep Blue
Daytime Mode	Red		Orange	Yellow	Green	Light Blue		Blue

13. Alarm

Either one of Bottom Alarm or Fish Alarm can be selected by a touchpad key on the front panel.

14. Power Supply

11-40 VDC universal, less than 25W

COMPLETE SET

No.	Name	Type	Code No.	Q'ty
1	Transducer	520-5PWB (incl. Transom Mount Bracket) 520-5PSB 520-5MSB	000-015-087* 000-015-088** 000-015-089***	1
2	Display Unit	CV-662		1
3	Installation Materials	CP02-02700	000-024-784	1 set
4	Accessories	FP02-00600	000-024-928	1 set
5	Spare Parts	SP02-02100	000-024-730	1 set

* for transom mount
 ** plastic, for thru-hull mount
 *** metallic, for thru-hull mount

INSTALLATION MATERIALS

No.	Name	Type	Code No.	Q'ty
1	Power Cable Assy	22S0023	000-109-518	1

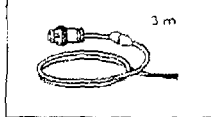

ACCESSORIES

No.	Name	Type	Code No.	Q'ty	Fig.
1	Bracket	FP02-00410	001-351-710	1	1
2	Viewing Hood	FP02-00610	001-355-920	1	2
3	Knob Bolt	KG-B2, M8 x20	000-800-418	2	3
4	Knob Washer	05-012-0125	591-201-251	2	4
5	Rubber Washer	02-052-1302	100-022-531	2	5
6	Tapping Screw	6x20, SUS304	000-800-414	4	6

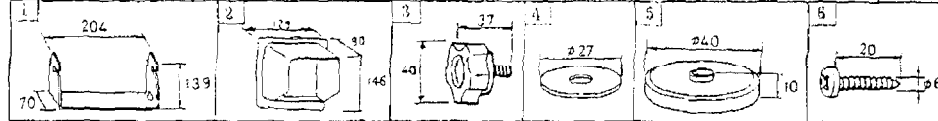

SPARE PARTS

No.	Name	Type	Code No.	Q'ty
1	Fuse	FGBO-A 3A AC125V	000-549-063	2

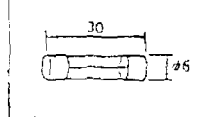

OPTION

No.	Name	Type	Code No.	Q'ty
1	Speed/Temperature Sensor	ST-01PTB ST-01PSB ST-01MSB	000-109-503* 000-109-504** 000-109-505***	1
2	Sensor Bracket	OP02-30	001-358-850*	1
3	Kick-up Bracket	OP02-29	001-358-840*	1
4	LC-90 Connection Kit	OP02-28	000-014-400	1
5	Adhesive	OP-31	000-356-518	1
6	Rectifier	PR-62, 100VAC " , 110VAC " , 220VAC " , 230VAC	000-013-484 000-013-485 000-013-486 000-013-487	1

SYSTEM CONFIGURATION

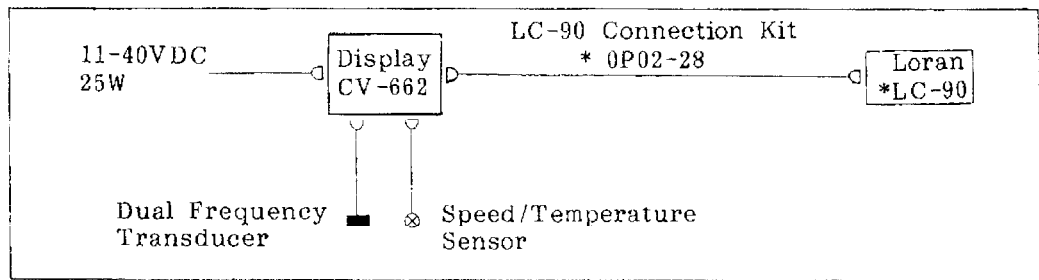

TRANSDUCER MOUNTING METHODS

TRANSOM MOUNT	①	②	③
Transducer	520-5PWB		
Bracket (Option)	none		Kick-up Bracket 0P02-29
HULL BOTTOM MOUNT	④	⑤	
Transducer	520-5PSB or 520-5MSB		

SPEED/TEMPERATURE SENSOR MOUNTING METHODS

TRANSOM MOUNT	A	B	C
Sensor (Option)	ST-01PTB		
Bracket (Option)	Sensor Bracket 0P02-30	none	
HULL BOTTOM MOUNT	D		
Sensor (Option)	ST-01PSB or ST-01MSB		

PRINCIPLE OF OPERATION

The FCV-662 Color Video Sounder determines the distance between its transducer and underwater objects such as fish, lake bottom or seabed and displays the results on a 6" color screen. It does this by utilizing the fact that an ultrasonic wave transmitted through water travels at a nearly constant speed of 4800 feet (1500m) per second. When a sound wave strikes an underwater object such as fish or sea bottom, part of the sound wave is reflected back toward the source. Thus by calculating the time difference between the transmission of a sound wave and the reception of the reflected sound wave, the depth to the object can be determined. In a sense an echo sounder can be thought of as being an extremely sophisticated and quick timer, since it is capable of resolving time differences shorter than one thousandth of a second.

The entire process begins in the display unit. Transmitter power is sent to the transducer as a short pulse of electrical energy. The electrical signal produced by the transmitter is converted into an ultrasonic signal by the transducer and transmitted into the water. Any reflected signals from intervening objects (such as a fish school) are received by the transducer and converted back into an electrical signal. It is then amplified in the amplifier section, and finally, displayed on the screen.

The picture displayed by the FCV-662 is made up of a series of vertical scan lines, one for each transmission. Each line represents a "snapshot" of what has occurred beneath the boat. The series of snapshots are accumulated side by side across the screen, and the resulting contours of the bottom and fish between the bottom and surface are displayed. The amount of history of objects that have passed beneath the boat over a series of transmission varies from less than a minute to several minutes, depending on how you adjust the unit. For further details, see page 20, Picture Advance Speed Selection.

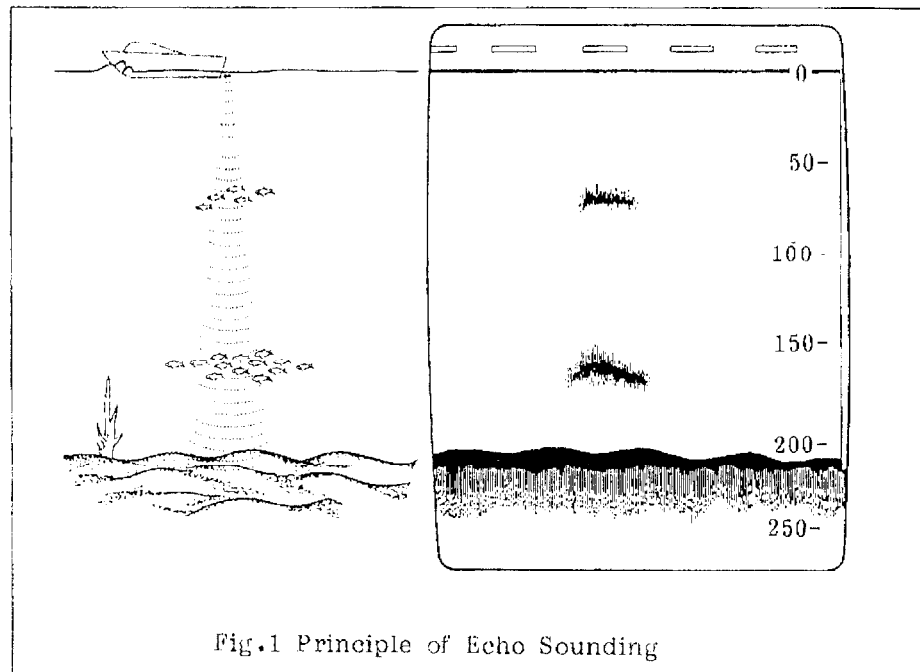

INSTALLATION

TRANSDUCER INSTALLATION

The FCV-662 is available with either a transom mount, inside-hull mount or through-hull mount transducer. This section of the manual shows the installation procedure for each transducer.

The performance of this video sounder is directly related to the mounting location of the transducer, especially for high-speed cruising. The installation should be planned in advance, keeping the standard cable length (8m) and the following factors in mind.

- 1) Air bubbles and turbulence caused by movement of the boat seriously degrade the sounding capability of the transducer. The transducer should, therefore, be located in a position where water flow is the smoothest. Noise from the propellers also adversely affects performance and the transducer should not be mounted nearby. The lifting strakes are notorious for creating acoustic noise, and these must be avoided by keeping the transducer inboard of them.
- 2) The transducer must always remain submerged, even when the boat is rolling, pitching or up on a plane at high speed.

For displacement hulls, using inside-hull and through-hull installations, a practical choice would be somewhere between 1/3 and 1/2 of the boat's length from the stern. For planing hulls, a practical location is generally rather far astern, so that the transducer is always in the water regardless of the planing attitude.

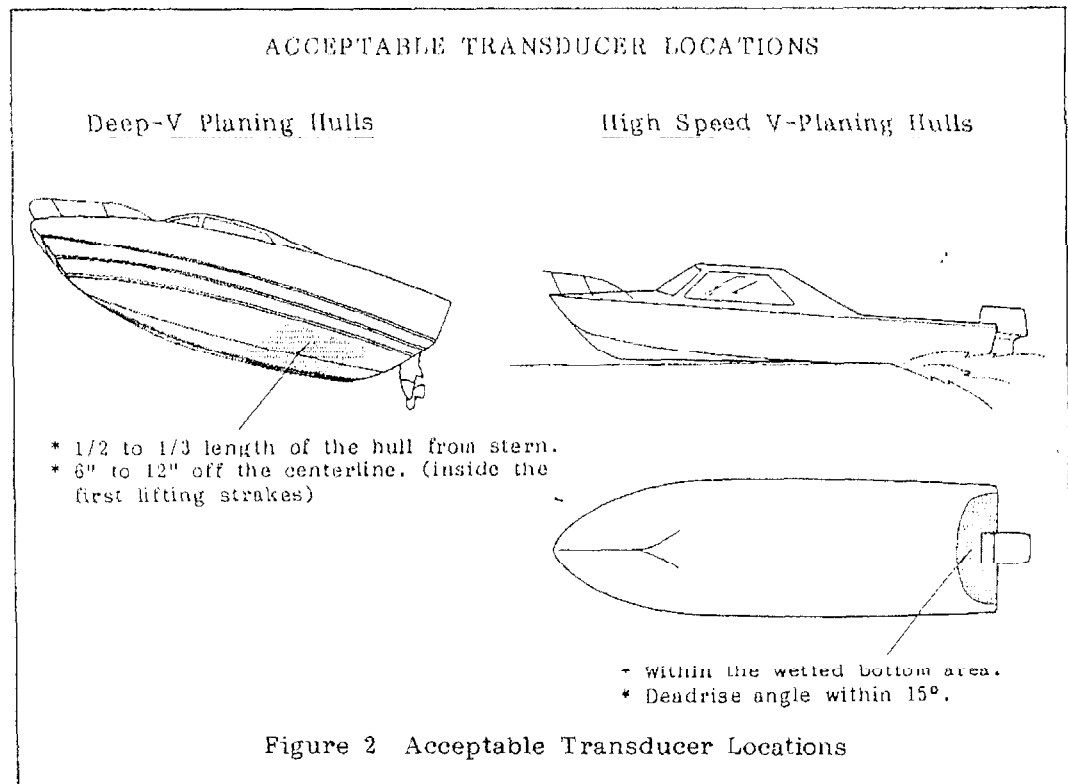

Transom Mount

This type of mounting is very commonly employed, usually on relatively small I/O or outboard boats. Do not attempt this mounting on an inboard boat due to turbulence created by the propeller ahead of the transducer.

1. Attach the transducer to the bracket as shown in Fig.3.
2. To determine a suitable transducer mounting location, run the boat at several speed ranges and observe the water flow at the rear and near the transom. Suitable location is at least 50 cm (18") away from the engine and where the water flow is smooth.
3. On a relatively flat hull, the transducer is mounted flush with the hull-bottom, and there are two choices of installation as shown in Fig.3. Note that the direction of the transducer and its fixing holes on the brackets are different for each method. Although there is less influence from air bubbles with method (b), you must be careful not to damage the transducer when the boat is hauled out of the water/put on a trailer. On a deep "V" hull, the transducer is mounted in the same manner as method (b) for the flat hull. It should be mounted as near as the bottom edge of the transom, and the transducer face must be parallel with the seabed, not with the hull bottom.

The temperature/speed sensor ST-01PTB can be directly attached to the transducer as shown on page AP-1 provided that the transducer is mounted in method (b). If method (a) is taken, the sensor should be mounted separately.

4. Mark the screw locations by holding the transducer in position on the transom.
5. Drill four pilot holes for the mounting screws.
6. Mount the transducer and secure it with four self-tapping screws. A small amount of sealing compound under the head of each screw will preserve the watertight integrity of the transom.

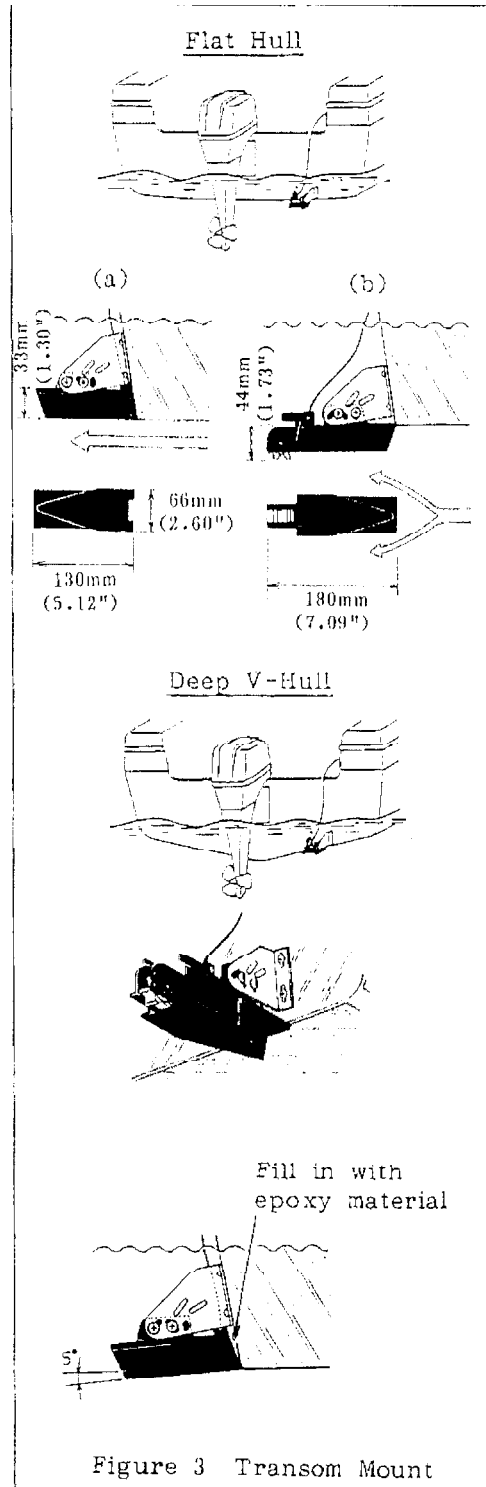

Figure 3 Transom Mount

7. Adjust the transducer position so that the transducer faces right the seabed.
8. If necessary, to improve water flow and minimize air bubbles staying on the transducer face, incline the transducer about 5° at the rear. This may require a certain amount of experimentation for fine-tuning at high cruising speeds.
9. Fill the gap between the wedge front of the transducer and transom with epoxy material to eliminate any air spaces.

Inside-Hull Mount (Transducer Type: See figure 6 on page 10.)

While this is by no means an optimum mounting scheme for deep-water sounding, this type of mounting can sometimes be used on fiberglass boats. A transducer can be likened to an antenna used with a TV set. Mounting an antenna inside your attic is like mounting an echo sounder transducer inside the hull. Both will work well enough, but are hardly optimum for either TV or echo sounder operation. In addition to the general considerations described on page 6, it is important to ensure that the transducer be placed in an area that has a single-hull thickness and is void of air or flotation materials other than solid fiberglass between the transducer face and the water. Also, the transducer face should not be placed over hull struts or ribs which generally run under the hull. Further, a location where the rising angle of the hull exceeds 15° should be avoided to minimize the effect of the boat's rolling.

It is advisable that the mounting location be finalized through a little trial and error after all other installation works have been completed. Temporarily put some silicone grease (not the type that sets up after drying!) inside the hull. Push the transducer down to squeeze out any air bubbles. Turn on your unit. Run the boat at various speeds and move the transducer to different locations to select the position where the best picture is obtained. Once a good location is found, you may permanently mount the transducer.

The inside-hull mounting is accomplished as follows. See figure 6 for outline drawings.

1. Lightly roughen the transducer face with fine #10 sandpaper and degrease it with a solvent (thinner or alcohol). Also, roughen and degrease the inside of the hull where the transducer is to be mounted.
2. Allow both to dry completely, then coat the transducer face and hull with the adhesive supplied. In a cold environment, you should warm the adhesive to approximately 40°C before usage to soften it.
3. Press the transducer firmly down on the hull and gently twist it back and forth to remove any air which may be trapped in the adhesive. Allow sufficient time for the adhesive to dry.

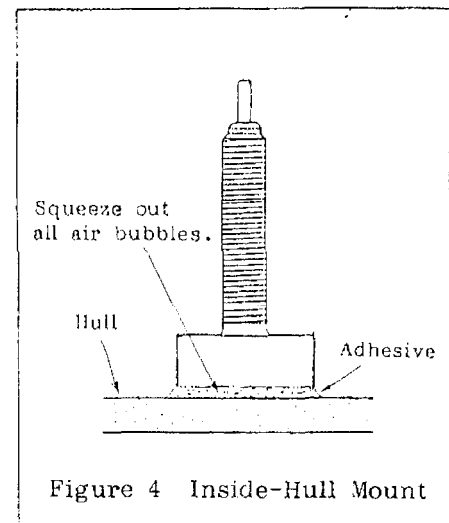

Through-Hull Mount (Transducer Type: See figure 6 on page 10.)

This type of mounting provides the best performance of all, since the transducer protrudes from the hull and the effect of air bubbles and turbulence near the hull skin is reduced. To determine the transducer location, keep in mind the general considerations described on page 6. Also, when the boat has a keel, the transducer should be at least 30 cm (1 foot) away from it. Typical through-hull mountings are illustrated in Figure 5.

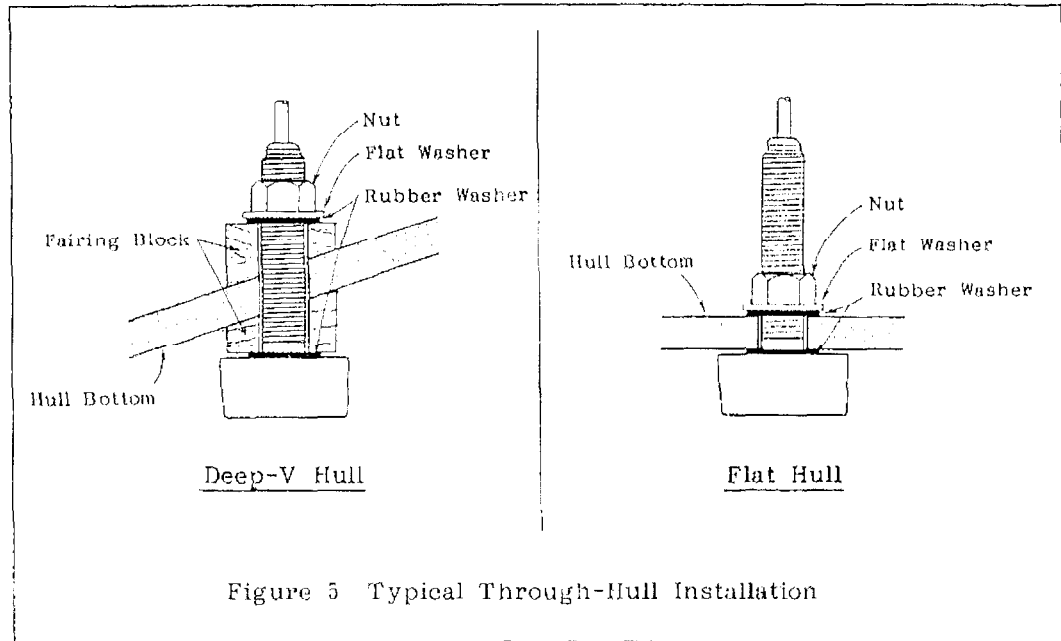

Figure 5 Typical Through-Hull Installation

Through-hull mounting is accomplished as follows.

1. With the boat hauled out of the water, mark the location selected for mounting the transducer on the bottom of the hull.
2. If the hull is not level within 15 degrees in any direction, fairing blocks made out of teak should be used between the transducer and hull, both inside and outside, to keep the transducer face parallel with the water line. Fabricate the fairing block as shown in Figure 6 and make the entire surface as smooth as possible to provide an undisturbed flow of water around the transducer. The fairing block should be smaller than the transducer itself to provide a channel to divert turbulent water around the sides of the transducer rather than over its face.
3. Drill a hole just large enough to pass the threaded stuffing tube of the transducer through the hull, making sure it is drilled vertically.
4. Apply a sufficient amount of high quality caulking compound to the top surface of the transducer, around the threads of the stuffing tube and inside the mounting hole (and fairing blocks if used) to ensure watertight mounting.
5. Mount the transducer and fairing blocks and tighten the locking nuts. Be sure that the transducer is properly oriented and its working face is

parallel to the waterline. Do not over-stress the stuffing tube and locking nuts through excessive tightening, since the wood block will swell when the boat is placed in the water. It is suggested that the nut be tightened lightly at installation and retightened several days after the boat has been launched.

CAUTION

The tightening torque should not exceed 400kg-cm. Excessive stress will cause damage to the threads of the plastic stuffing tube.

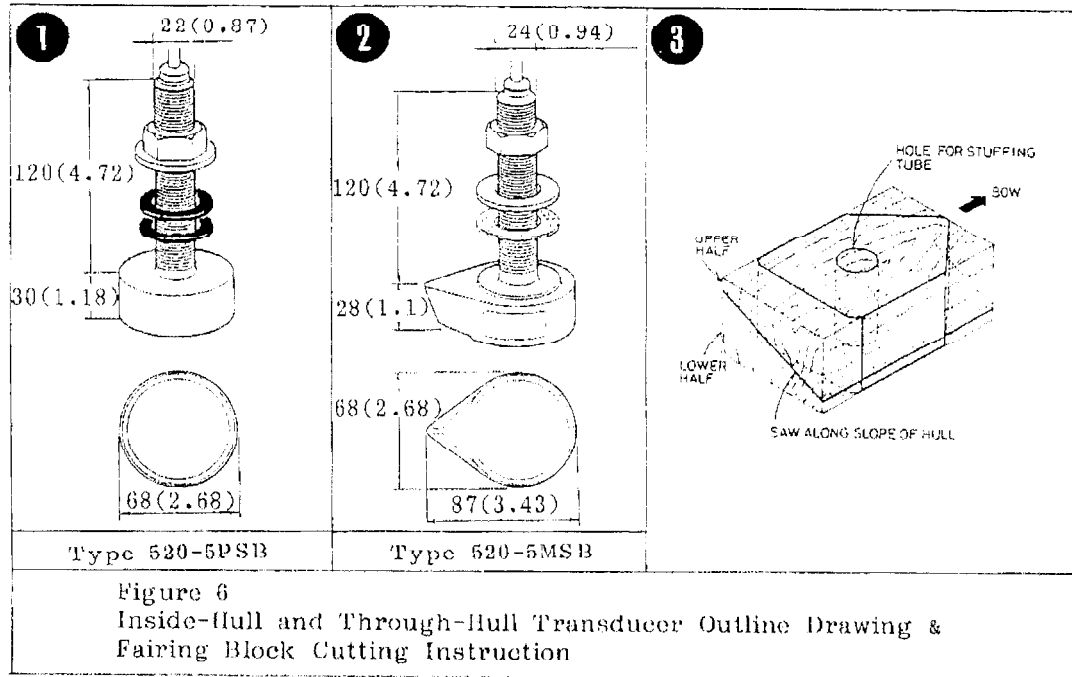

Transducer Preparation and Painting

Just prior to putting your boat into the water, the face of the transducer should be thoroughly wiped with a detergent liquid soap. This will lessen the time necessary for the transducer to establish good contact with the water. Eliminating this will lengthen the time required for complete "saturation" and will reduce the performance of the unit.

To maintain the sensitivity of the transducer, do not coat the face with heavy pigmented antifouling paints, i.e., cuprous oxide types. Use only a light, thin coat of a vinyl based antifouling paint, like International Paint's TRI-LUX No.67 or No.68.

DISPLAY UNIT INSTALLATION

Mounting Location

The display unit is carefully constructed to be able to withstand the humidity and corrosive atmosphere common in the marine environment, but it is not designed to be used outside, directly exposed to that environment. Salt water spray will most assuredly cause damage to the sensitive components inside. Keep these and the following factors in mind when planning the installation of the display unit.

CAUTION

Furuno will assume no responsibility for the damage caused by exposure to either fresh or salt water.

- 1) The display unit consumes very little power, so there is no need of forced air ventilation. However it is necessary to provide at least some circulation of cooling air by allowing sufficient space around the unit.
- 2) Many owners will undoubtedly use the FCV-662 on small boats, many with center consoles. The display unit must be mounted inside an enclosed cabinet, completely shielded from salt water spray, and from fresh water spray if the boat is usually hosed down after a day's outing. Most small center console boats are equipped with such an enclosed cabinet behind the wheel, and most have clear doors so that equipment may be seen behind them.
- 3) Even though the picture is quite legible even in direct sunlight, it is recommended to keep the display unit out of direct sunlight or at least shaded because of heat that can build up inside the cabinet.
- 4) Consideration should be made to provide space for access to the mounting hardware on the side and connectors behind the display unit. Also allow at least a foot or so of "service loop" in the cables to allow the unit to be pulled forward for servicing or internal adjustment.
- 5) The display unit can be mounted on either a table-top, bulkhead or overhead. Make sure that the selected location is strong enough to support the unit under the conditions of continued vibration or shock which will be normally encountered on the boat. If necessary, appropriate reinforcement measures should be taken in the mounting area.
- 6) The display unit should be mounted apart from equipment(s) emitting heat. Also, do not put thing(s) on the top of the unit.

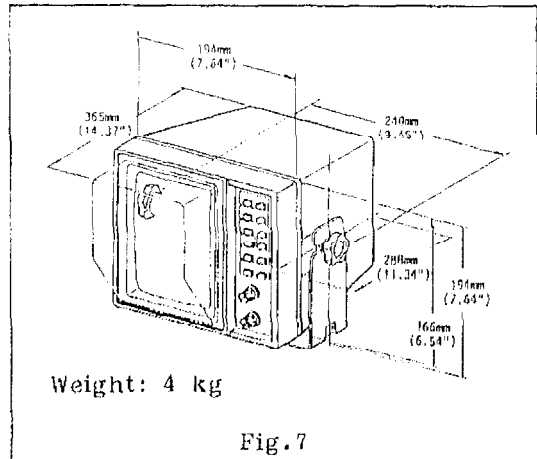

Mounting the Display Unit

1. Mark the screw locations by using the bracket as a template.

2. Drill four pilot holes for the bracket.
3. Install the bracket by using the screws supplied.
4. Fit knobs, rubber washers and knob washers to the display unit.
5. Install the display unit in the bracket. Tighten the knobs securely.

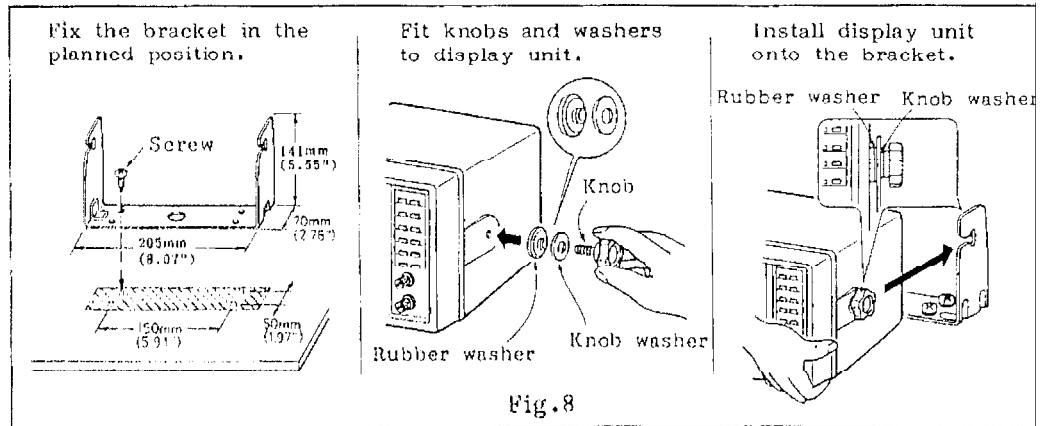

CABLE CONNECTIONS

Cable connections to the FCV-662 display unit are made at the connector located at the rear of the unit. Fig.9 shows the wiring instructions.

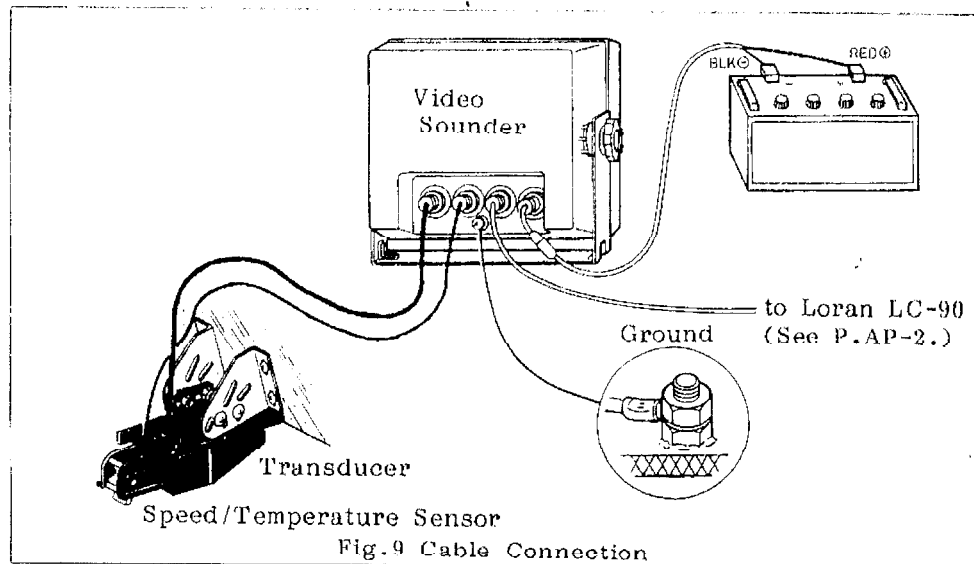

Transducer Cable Connection to Display Unit

In order to minimize the chance of picking up electrical interference, avoid where possible routing the transducer cable near other on-board electrical equipment. Also avoid running the cable in parallel with power cables.

Power Cable Connection

The FCV-662 is designed to operate normally at any voltage between 11 and 40Vdc. The power should be directly taken from the distribution board or breaker panel.

Connect the red lead of the cable to the positive (+) terminal of the battery and the black lead to the negative (-) terminal.

CAUTION

Reversing the polarity will result in blowing the fuse and may very well damage internal components.

GROUNDING

The FCV-662 is designed to operate normally without grounding the display unit, provided that the cable routing precautions stated before are taken. However in some cases, interference may show up at high gain settings, and it may become necessary to ground the unit to the boat's grounding bus to eliminate the problem. In such cases, run a heavy duty ground wire from the grounding terminal on the rear bottom of the display unit to the nearest grounding point on the boat.

On a fiberglass boat, it is best to install a ground plate that measures about 20 cm by 30 cm (0.8 feet by 1.0 feet) on the outside of the hull bottom to provide a ground point. If this is not practical, the engine block can be used.

BASIC OPERATION

INTRODUCTION

The FCV-662 is provided with two pages of PICTURES, "A" and "B", either of which can be selectively projected onto the CRT screen. Note that both pictures "A" and "B" are concurrently produced. While you are watching picture "A" on the screen, for example, picture "B" which is unseen on the screen is produced in the background as well, and an up-to-date picture is readily available there ("B") for projection onto the screen instead of "A".

Each PICTURE has six presentation modes shown in Fig.10 and you will select one of them. "LOW" means that the picture is painted by using the low-frequency transceiver, and the "HIGH" by the high-frequency transceiver.

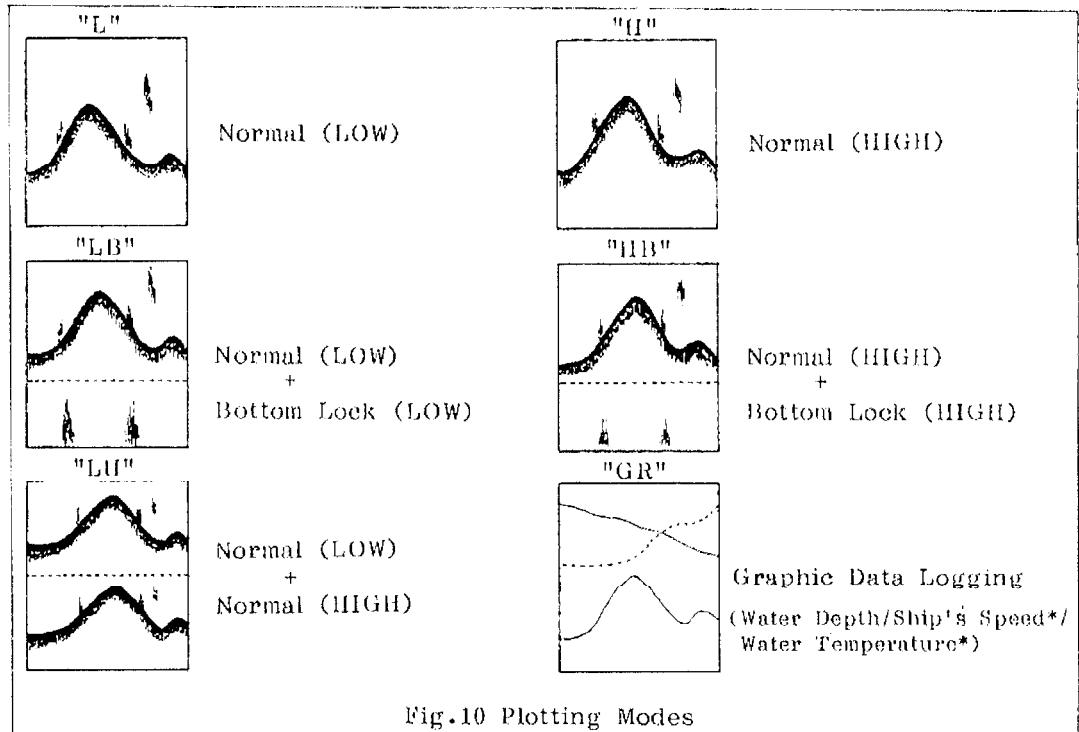

* For display of ship's speed and water temperature, an optional sensor device is required.

Controls of the picture, such as the basic range or range phasing, are given to pictures "A" and "B" commonly from the front panel. An exception to this rule is the picture advance speed, which can be controlled independently for both pictures.

As you can see, your unit is quite sophisticated. But don't worry. Operation is quite easy; pressing of each touchpad is acknowledged by a beep sound, and keying sequence is smartly organized and acknowledged by alphanumeric/symbolic indicators on the screen.

- 2) Now you can select any item under the function. Press the ▲▼ keys until your intended item indicator appears on the upper part of the screen. See page 30. For example, if you are presently using Basic Range "5" and want to change it to "3", press the ▼ key until "3" is displayed to the right of the "I" symbol at the top of the screen.

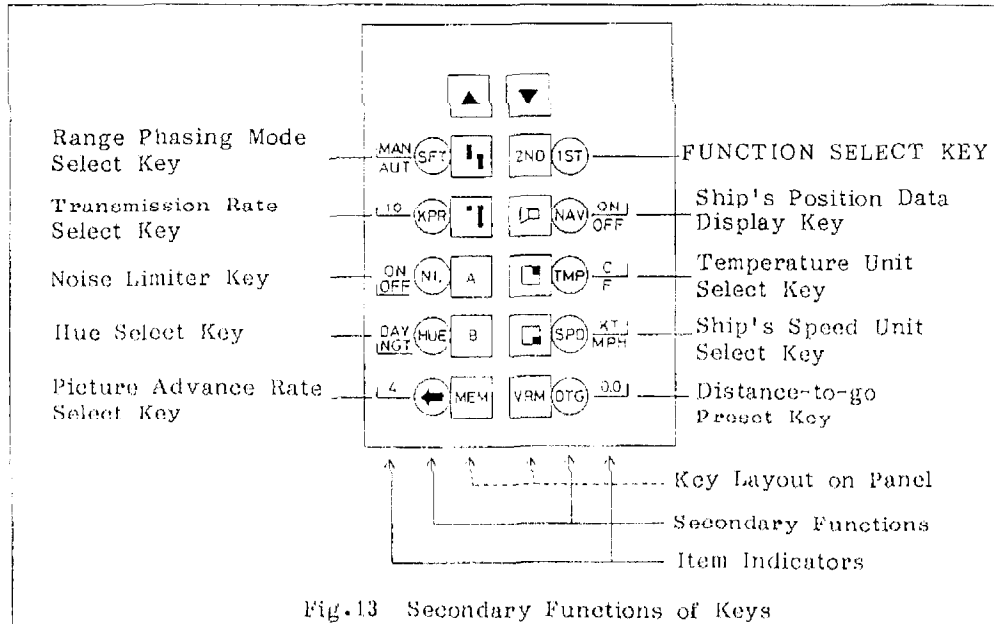

When the SECONDARY function is selected as illustrated above, keying operation is quite simple. Every pressing of a Function key moves the underline "L" between the item names or changes the numeral which is displayed beside the key symbol. In Fig.13, the Range Phasing, for example, is presently in the MANUAL mode since the underline "L" is appearing under the MAN. If you press the (SFT) switch, this underline moves under the AUT and the AUTOMATIC Range Phasing mode is selected. Likewise, the Transmission Rate (set to 10 at present) changes with every pressing of the (KPR) key.

For operator convenience, the SECONDARY function key symbols are displayed on the screen with a circle as opposed to the square figures of the PRIMARY functions. Do not forget to select the SECONDARY function beforehand when it is instructed to press the "round" function key in the following pages.

Power ON/OFF and Brilliance Control:

Power is supplied to the unit by turning the  knob clockwise until a click is heard. Further clockwise rotation adjusts the screen brilliance. To extend the life of the CRT, do not unduly increase the brightness of the screen. Note that there is a 6-10 sec. delay prior to display of the picture while the CRT warms up. Every time power is applied, the primary and secondary functions will default as shown in

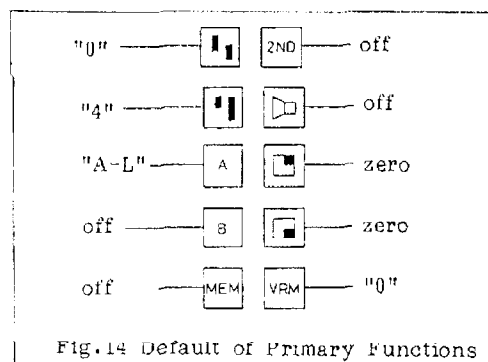

Figures 14 and 13 respectively.

To turn off the unit, turn the knob fully counterclockwise until a click is heard.

Picture Page and Presentation Mode Selection A ▲ ▼ B ▲ ▼

Press of the A (B) key instantly projects the picture "A" ("B") onto the screen.

To select the presentation mode, first press the A or B key even if your intended picture page is already shown on the screen, and press of the ▲ ▼ keys directly afterwards changes the presentation mode. For example, if you want to set the Graphic Data Logging mode on the picture page "B", first press the B key and then press the ▲ or ▼ key a few times until the "B-GR" is displayed at the top center of the screen. See page 30.

Item Indicator	Presentation Mode
"H"	Normal (HIGH Frequency)
"L"	Normal (LOW Frequency)
"HB"	Normal + Bottom Lock (HIGH Frequency)
"LB"	Normal + Bottom Lock (LOW Frequency)
"LH"	Normal (LOW) + Normal (HIGH)
"GR"	Graphic Data Logging

It is recommended to use picture "A" with your most often used mode; "L" ("H") for normal fishing in the deep (shallow) water, "LB" ("HB") for bottom trawling in the deep (shallow) water or "LH" for discrimination of fish species.

Suggestion on selecting frequency

- 1) Combination of high frequency and high transmission rate (see page 26) is very useful to detect species which do not have air bladders (e.g., sharks) or which are very small and do not readily reflect the echo.
- 2) When the sea is rough, noise (reddish color) heavily covers the surface layer, and sounding is easily interrupted by aerated water which passes below the transducer. It should be noted that a high frequency is less influenced by rough sea when compared with a low frequency. However, in the application where observation of DSL (plankton layer) is first essential, use low frequency because such scattering objects are clearly plotted.
- 3) To watch the seabed condition in bottom trawling, a low frequency is preferable because the seabed is plotted thickly and changes of the width can be easily noticed; a wide seabed trace indicates a hard and a narrow trace a soft seabed.
- 4) The "LH" mode offers dual watch of both low and high frequencies. In this mode, discrimination of species or fish size is possible through experience. A fish body reflects both low and high frequencies, but the proportion of reflection differs from fish to fish. Also, it is widely known that tiny fish reflects high frequencies than low frequencies.

- 5) Though a high frequency offers a sharp, clear-cut picture, its use should be limited to shallow water fishing because it is easily attenuated in the water.

Bottom Lock Presentation

Selecting the "HB" or "LB" mode provides a compressed normal picture on the upper 2/3 of the screen and a 10ft (2.5m, 1.25fa, 2.5P/B) wide layer in contact with the seabed is expanded onto the rest of the screen with the seabed contour aligned. The range of expansion can be easily recognized on the normal picture because it is marked with a YELLOW line as illustrated below. This mode of presentation is indispensable for bottom trawling.

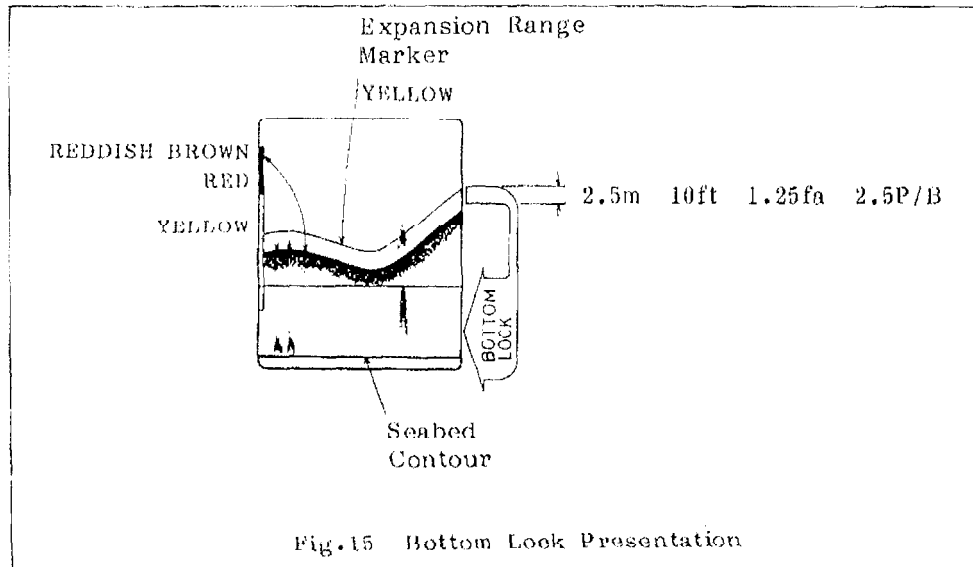

For the bottom-lock presentation, the seabed contour must be steadily and distinctly plotted in RED or REDDISH BROWN color. Adjust the Gain Control for the best seabed presentation. Too high a setting of the control in shallow water may cause heavy surface noise that reach the seabed, causing erratic bottom lock operation.

Contrary to picture "A", it is recommended to utilize picture "B" for your secondary purpose. Suggested are "GR" (Graphic Data Logging) (see page 30) and echo plotting with a slow picture advance rate (see page 20) to observe long-termed transition of underwater conditions, etc.

Normal Picture Range Selection

The Basic Range and Range Phasing functions used together give the operator the means to select the depth he can observe directly under the boat. The Basic Range can be thought of as providing a "window" into the water column. The start of this window is determined by the setting of the Phased Range selection. For example, if you select Basic Range "5", you will have a 250-foot deep viewing area, which may be moved anywhere in the water column by using the Range Phasing function. To continue our example, if the Phased Range is set to 50 feet, the top of the range window would be at 50 feet, and the bottom of the range window would be at 250 plus 50 feet or 300 feet.

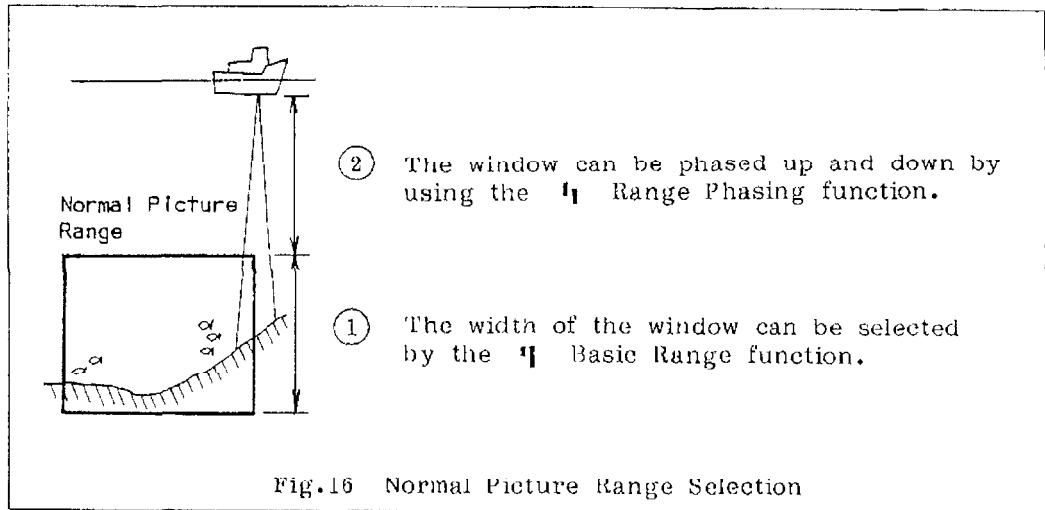

Basic Range Selection **⏏** **▲** **▼**

Press of the **⏏** key followed by the **▲▼** keys selects the basic range:

Setting	1	2	3	4	5	6	7	8
Meters	5	10	20	40	80	160	240	320
Feet	15	30	60	120	250	500	750	1000
Fathoms	2.5	5	10	20	40	80	120	160
P/B	4	8	16	32	60	120	180	250

The basic range is indicated to the right of the **⏏** symbol at the top of the screen.

Range Phasing **⏏** **▲** **▼**

The range (window) selected may be phased up and down by pressing the **▲▼** keys directly after the **⏏** key. The amount of range phasing, e.g., the depth at the upper limit of the window, is digitally indicated at the top right corner of the screen with the "**⏏**" symbol. Step of range phasing with the **▲** or **▼** key differs with respect to the basic range settings.

Setting	1	2	3	4	5	6	7	8
S Meters	1	2	5	10	20	60	50	100
T Feet	5	10	20	40	50	100	250	250
E Fathoms	1	1	2	5	10	20	40	50
P P/B	1	2	5	5	20	40	50	50

(How to move the window quickly between extreme points)

If you are presently using a small Basic Range Window and a large Phased range setting to set the start of the display window, and should you want to change the phasing back to zero, then you would find that this can be accomplished by holding down the **▲** key continuously, but since the increments of change are small, that it would take a long time to get back to zero. In this case, it is better to change the Basic Range to a higher setting, and then hold down the Phased Range key to get back to zero phasing more quickly.

For example, if you are using a Basic Range setting of "2" (30-foot range window), and a Phased Range setting of 550 feet, a single push on the ▲ Phased Range key will cause a change of only 10 feet, meaning that you will have to hold down the key for a rather long time before getting to zero. Instead, change the Basic Range to "8". Now the increments of change for the Phased Range keys are 250 feet, and you can get back to zero quickly. Return the Basic Range back to what you want after this.

NOTE

For the manual range phasing mentioned above, the manual shift mode must be preselected. See page 23.

Gain Control ◀

The Gain control adjusts the sensitivity of the receiver. Normally, the gain is set to the point just below where excessive noise appears on the screen. As a general rule of thumb, use a higher gain setting for greater depths and a lower setting for shallower waters. For example, if you are looking for fish between the surface and the bottom in a range of perhaps 20 to 50 feet, you may not be concerned at all with seeing the bottom. You might use a Basic Range setting of "3" (60 foot range window) with a Phased Range setting of 0. You would bring up the gain until excessive noise is shown between the surface and bottom and then you would back off just a little. Now fish will show when they are encountered.

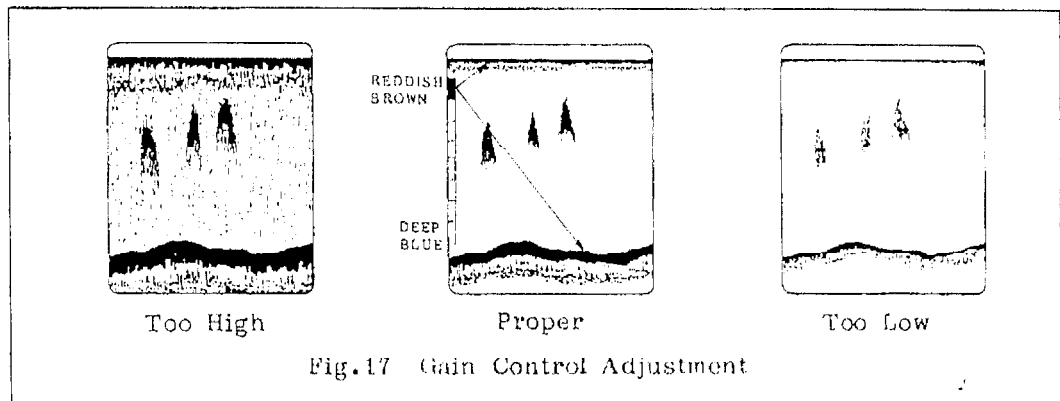



As another example, if you are interested in seeing fish close to or on the bottom at 150 feet, you might be using a Basic Range of "3" (60-foot window) with a Phased Range setting of 100 feet. Here you would bring up the gain until the bottom is shown in the highest intensity level, BRIGHT, and then increase the gain a bit further until excessive noise appears on the screen. Again you would back off the gain until the noise just disappears. In both of these cases you are setting up the maximum level of usable gain, assuring you of the greatest possibility for seeing fish.

Picture Advance Speed Selection: ◀ ▶ ▼

Because the picture is built up one scan line at a time, from right to left across the screen, the amount of history displayed on the screen is directly related to the picture advance speed. At the fastest advance speed "4", each transmission results in one scan line being produced on the screen.

With the slowest advance speed "1", you will only see one scan line produced for every 6 transmissions. This will result in a longer amount of history being shown on the screen.

Press of the   keys determines the speed of picture advance from right to left across the screen. The fractions in the table below correspond to how many transmissions are necessary to construct one scan line. For example, if the Picture Advance Speed is set to "4" (fastest), with a Basic Range setting of "4", and a Phased Range setting of 50 feet, an echo will remain on the screen for approximately 45 seconds.

As another example, using the same Basic and Phased Range settings above, if the Picture Advance Speed is set to "1" (slowest) an echo will remain on the screen for slightly over 5 minutes. If the advance speed is set to "0", the display will remain frozen indefinitely.

← Item Indicator	"0"	"1"	"2"	"3"	"4"
Scan Line/ Transmissions	(Freeze)	1/6	1/4	1/2	1/1

When selecting an advance speed, keep in mind the following guidelines.

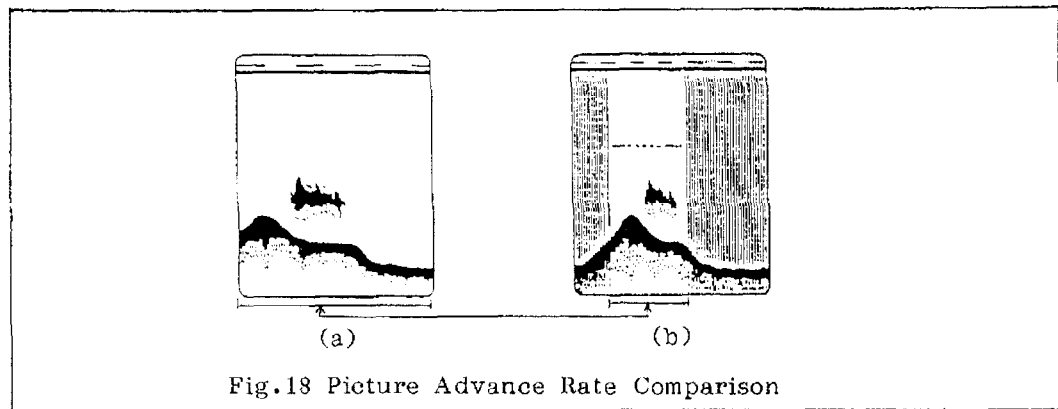

- 1) At faster advancement speeds ("3" or more), care should be taken not to misjudge the size of the fish school; a fast advance speed will expand the size of the school horizontally across the screen. (Fig.18a)
- 2) A slower advance speed ("2" or less) however will contract the size of the school across the screen. (Figure 18b)





USEFUL FUNCTIONS

Picture Record/Recall

In addition to pictures "A" and "B", another two picture record pages, "a" and "b", are provided for advanced operation.

Press of the  key followed by the  key causes the picture to stop advancing and records the picture. To return to the normal picture advance, press any key.

The recorded picture may be recalled onto the screen at any time by pressing the  and  keys in order. The recalled picture bears "MEM" indication at the top left corner. Upon pressing any key, the presentation will return to the original state.

It should be noted that when picture "A" ("B") is displayed, the above-mentioned operation records/recalls the picture to/from picture page "a" ("b"). Crossed record/recall is not possible; page "a" can not be recalled when picture "B" is displayed.

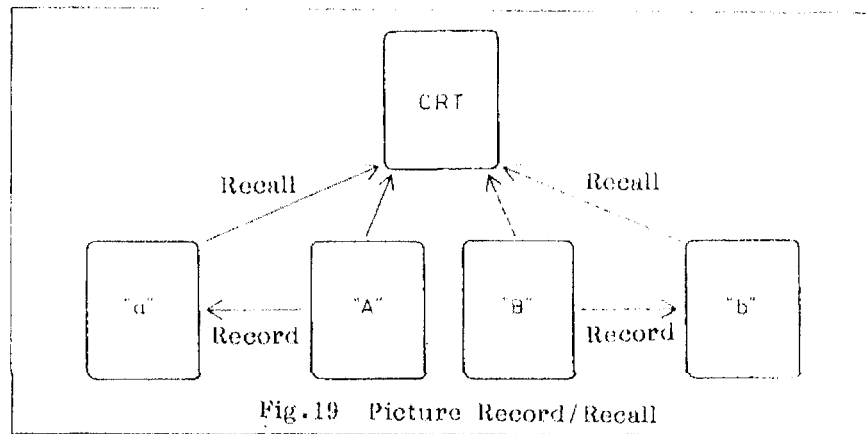





Fig.19 Picture Record/Recall

Target Depth Measurement by VRM:

After depressing the  key, press the   keys, and the green Variable Range Marker line which runs horizontally across the screen moves up and down. The depth of the marker line is digitally indicated above the line. See page 29.

By moving the VRM line onto a target echo, you can read out its exact depth.

Noise Limiter:

When noise interference from other echo sounders operating nearby or other types of electrical interference exist, you may use the Noise Limiter to eliminate or reduce the interference. (See Figure 20.) If the Noise Limiter is left on when no interference exists, weaker echoes may be missed or eliminated. An "NL" symbol appears at the center top of the screen to alert the operator that the Noise Limiter is "ON".

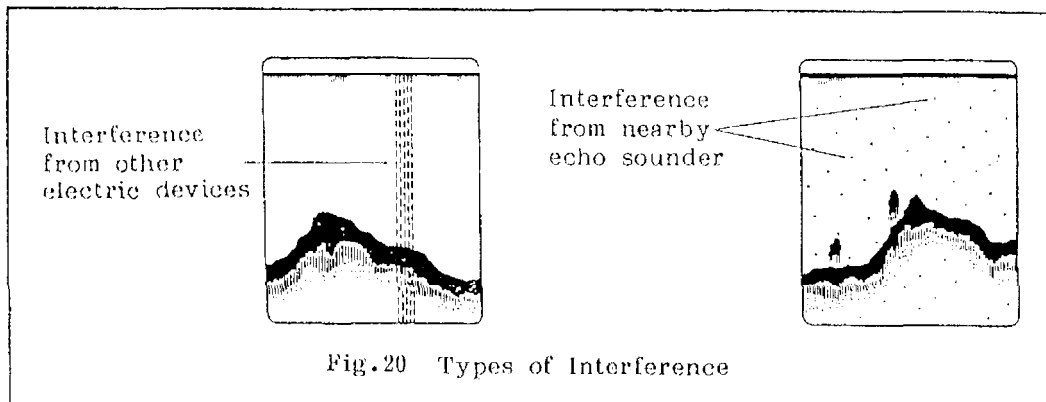

Fig.20 Types of Interference

Automatic Bottom Tracking: MAN SFT
AUT

Selection of the AUTOMATIC SHIFT mode disables the function of the 1 key, and instead the Basic Range window is automatically shifted up and down in accordance with the depth of seabed contour:

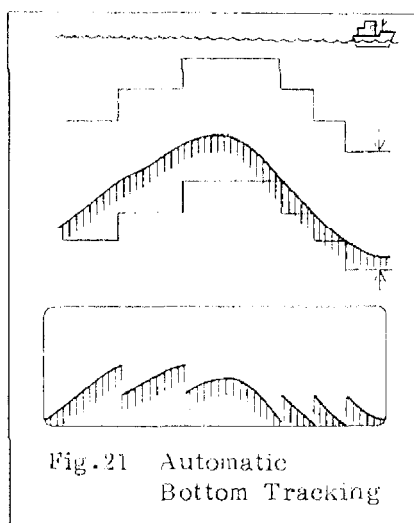

Fig.21 Automatic Bottom Tracking

The Basic Range window jumps up when the seabed trace rises up over the center of the normal picture, and jumps down when the seabed trace disappears from the lowest limit of the picture. The step of jumping is 1/4 of the basic range in use.

NOTE

- 1) This may be used with the "LB" or "HB" presentation.
- 2) When the seabed return becomes weak, the AUTO mode does not work and "AUT" indication disappears. Now, you can use the MANUAL shift function. To continue AUTO mode, increase the Gain for stable reception of the seabed echo.

Distance-to-go Preset/Distance Run Clear: D/G ▲ ▼

As illustrated on page 29, "Distance-to-Go" or "Distance Run" is displayed at the lower left corner of the screen. Press of the D/G key followed by the ▲▼ keys forces the digital readout to change for preset purpose. The value to be preset is displayed at the right of the D/G symbol indication. If non-zero mileage is preset, it is regarded as "distance-to-go"; the mileage is counted down in accordance with the ship's movement. It should be noted that the mileage readout decreases so long as the boat moves regardless of the ship's heading direction.

On the other hand, if the mileage is cleared to zero, it functions as the "distance-run meter"; the mileage is counted up in accordance with ship's movement.

NOTE: For "distance-to-go" or "distance run" indication, an optional sensor device is required.







Alarm: 

There are two types of objects which can trigger the alarm; the seabed and fish. Press of the  key selects the trigger source between the two objects and changes the item indication:

Item Indicator	"FA"(Fish Alarm)	"BA"(Bottom Alarm)	none
Alarm Trigger Source	Fish Echo	Seabed Echo	Alarm disabled.

When the "FA" mode is selected, the echoes which are plotted below the seabed contour are ignored, and only fish echoes can trigger the alarm. Contrary to this is the "BA" mode where only the seabed contour is watched. If you do not need the alarm function or wish to silence the alarm sound, press the key until the alarm indicator disappears.

Alarm Zone Preset:      

Press of the  key followed by the   keys changes the width of the upper-alarm zone which is indicated by a white color bar as illustrated below, and the    keys set the lower alarm zone. When both the upper and lower alarm zone bars are extended through one another, the crossover section of the bars becomes white and upper and lower portions disappear as illustrated below. This is the Midwater Alarm Zone.

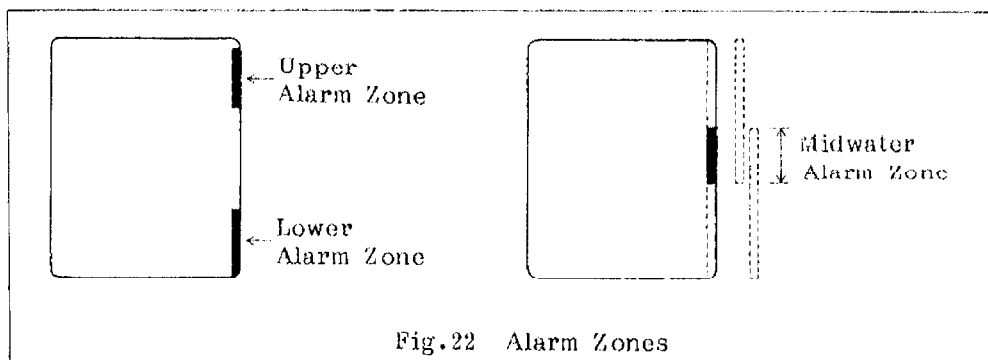

When fish (FA) or the seabed (BA) enter into the alarm zone, the alarm is released.

NOTE

- 1) Echo with a weak color can not trigger the alarm; the fish must be plotted in YELLOW or higher gradation color in the "FA" mode and the seabed must be RED or REDDISH BROWN in the "BA" mode.
- 2) An echo which is plotted within 1m from the zero line can not trigger the alarm.
- 3) When the "LH" (dual frequency) mode is selected, the echo in the low frequency picture serves to trigger the alarm. The high frequency picture is ignored by the alarm.

Typical Applications

(1) Bottom Alarm (Mode: "BA")

The Bottom Alarm can be thought of as a zone extending from the transducer down to a depth of water greater than the draft of the boat. In waters where the depth is known to dramatically and suddenly rise without warning, it may be a good idea to set the Bottom Alarm 10 (or even 20) feet below the boat's draft to warn of impending danger. For example, let us say that your boat has a draft of 3 feet, (i.e., the transducer is flush with the hull bottom, 3ft. below the surface) but you want to set a lower limit of 10 feet below the transducer as an alarm zone.

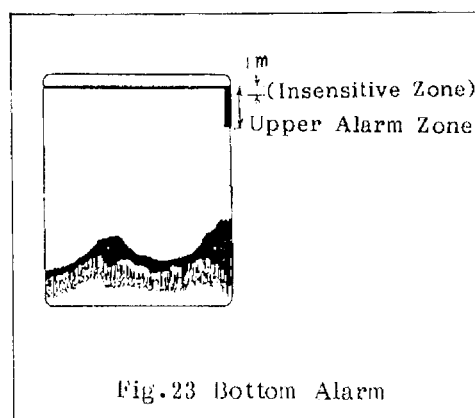

Fig.23 Bottom Alarm

Now use the $\square \blacktriangledown$ keys to move the indicator bar down from the top right-hand edge of the display to 10 feet. If you overshoot 10 feet, use the $\blacktriangledown \square$ key to get back to 10 feet. Now should the bottom rise into the indicated "forbidden" zone, the alarm will sound, and you know you must exercise caution before proceeding any further. Note that the bottom alarm only works more than 1m below the transducer to avoid locking on the transmission "main bang", and does only when the bottom is colored red or reddish brown.

(2) Fish Alarm for Bottom Fishing (Mode: "FA")

For bottom fishing, the alarm is set from the lower right-hand edge of the display upwards to a level set by the operator above the bottom. For example, if you are in 53 feet of water and your range setting is 0 to 60 feet, you might set the upper edge of the indicator bar at 43 feet. Now any fish that appears in the region between the bottom and 43 feet will sound the alarm. You would use the $\square \blacktriangleup$ keys to move the indicator bar.

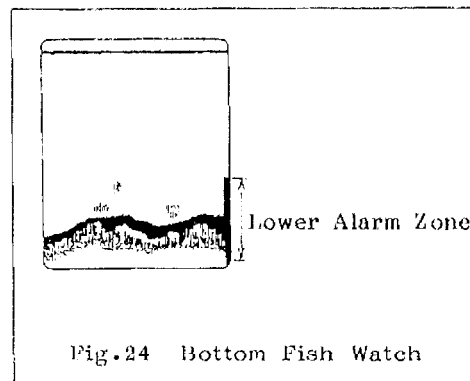









Fig.24 Bottom Fish Watch

(3) Fish Alarm for Surface/Midwater Fishing (Mode: "FA")

For surface or midwater fishing, you want the Fish Alarm to sound, should fish appear in an area somewhere between the transducer and the bottom. However, an alarm set all the way from the transducer downwards may cause a lot of false alarms because of surface turbulence. Thus you would probably want to set the top edge of the alarm zone to be below the surface turbulence seen on the screen.

For example, let's say that a particular species of fish you want to catch normally are found in the range between 30 and 60 feet, and the range shown on the screen is presently 0 to 120 feet. Press the $\square \blacktriangleright$ key to

activate the alarm. Next ensure that both Upper and Lower Alarm Zone indicator bars are off the screen by first pressing the   Upper Alarm Zone key continuously until the bar disappears from the screen and then pressing the   Lower Alarm Zone key until the bar also disappears. Then press the   Upper Alarm Zone key until the indicator bar moves down to the 60-foot mark. Now press the   Lower Alarm Zone key until the indicator bar coming from the bottom passes through the one extending from the top downwards and then release the key when the indicator bar reaches the 30 foot-mark. Any fish appearing in the zone will cause the alarm to sound.

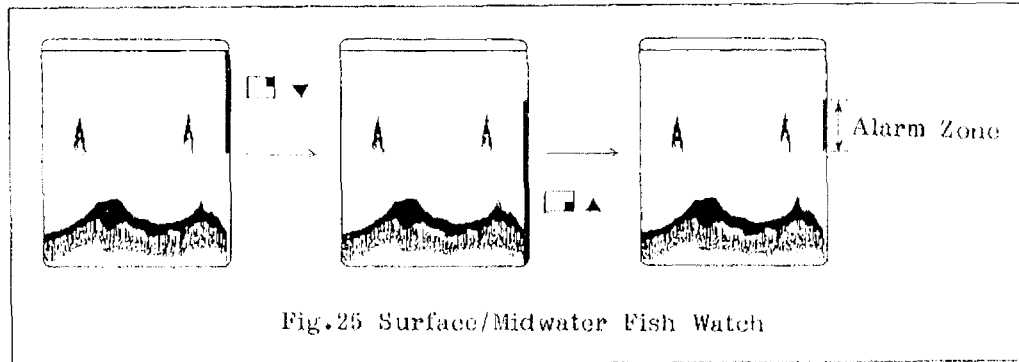

Temperature Unit Selection: 

Press of the  key changes the unit of the water temperature indication between Centigrade and Fahrenheit.

NOTE: For water temperature indication, an optional sensor device is required.

Ship's Speed Unit Selection: 



Press of the  key changes the unit of the ship's speed indication between Knots (Nautical Miles Per Hour) and Statute Miles Per Hour.



NOTE: 1. For ship's speed indication, an optional sensor device is required.
2. Unit of Distance-to Go or Distance Run is not changed, it is always in Nautical Miles.

Ship's Position Indication: 

Press of the  key turns on and off the ship's position indication.

NOTE: For ships position indication, a position fixing device must be connected.

Transmission Rate Selection:   

Press of the    keys changes the transmission rate in 11 steps.

Item Indicator	"0"	-----	"10"	"S"
TX Rate	lowest	-----	highest	AUTO

For detection of small objects in shallow water, a higher transmission rate is preferable as mentioned on page 17. Also when interference noise from another boat appears on the screen persistently, change the transmission rate with the \odot (Noise Limiter) turned on. See page 22.

Ship's Speed Dependent Mode "S"

As you may be aware of, an echo is plotted wider horizontally as the ship's speed decreases. As an extreme case, imagine that your boat is stationary and a small target exists just beneath the boat. Though the actual target is small in size, it will appear very long horizontally. Contrary to this is the case where the ship's speed is very fast; a target tends to appear narrow because the boat passes over the target in a short time. Thus you must always bear in mind that the picture expands horizontally as the ship's speed decreases and shrinks as the boat speeds up.

The solution for this inconvenience is the "S" (Ship's Speed Dependent) mode where the transmission rate and as a result the picture advance rate change automatically in proportion to the ship's speed. As shown in the illustration below, the horizontal scale of the picture is not influenced by the change of ship's speed.

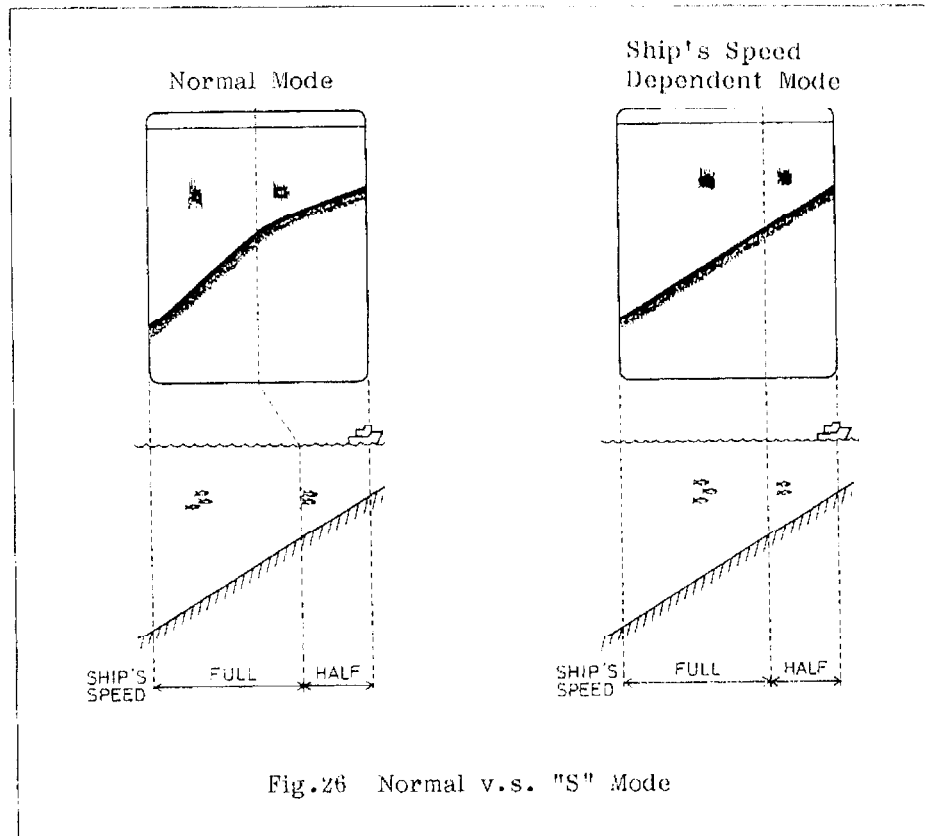

Fig.26 Normal v.s. "S" Mode

NOTE 1. For the Ship's Speed Dependent mode, an optional sensor device is required.

2. Even when the boat has stopped completely, the picture advances slowly. (If not, one can not interpret underwater conditions.)

Color Set Selection for Day and Nighttime Operations: DAY
NIGHT (HUE)

On this color sounder, targets are painted in 7 colors (background in DEEP BLUE) in accordance with the echo strength.

However when the equipment is used in a bright environment, select the 6 color set (5 colors on BLUE background) because the bright background is more easy to use.

Level	Strongest ← → No signal							
	7	6	5	4	3	2	1	0
Nighttime Mode	Reddish Brown	Red	Orange	Yellow	Green	Light Blue	Blue	Deep Blue
Daytime Mode	Red		Orange	Yellow	Green	Light Blue		Blue

INDICATORS

Echo Presentation Mode: "L", "H", "LB", "HB", "LH"

The following shows all the various indicators that show up on the echo presentation mode pictures. As most of the indicators have been explained in connection with keying operations, description is given to only a few items.

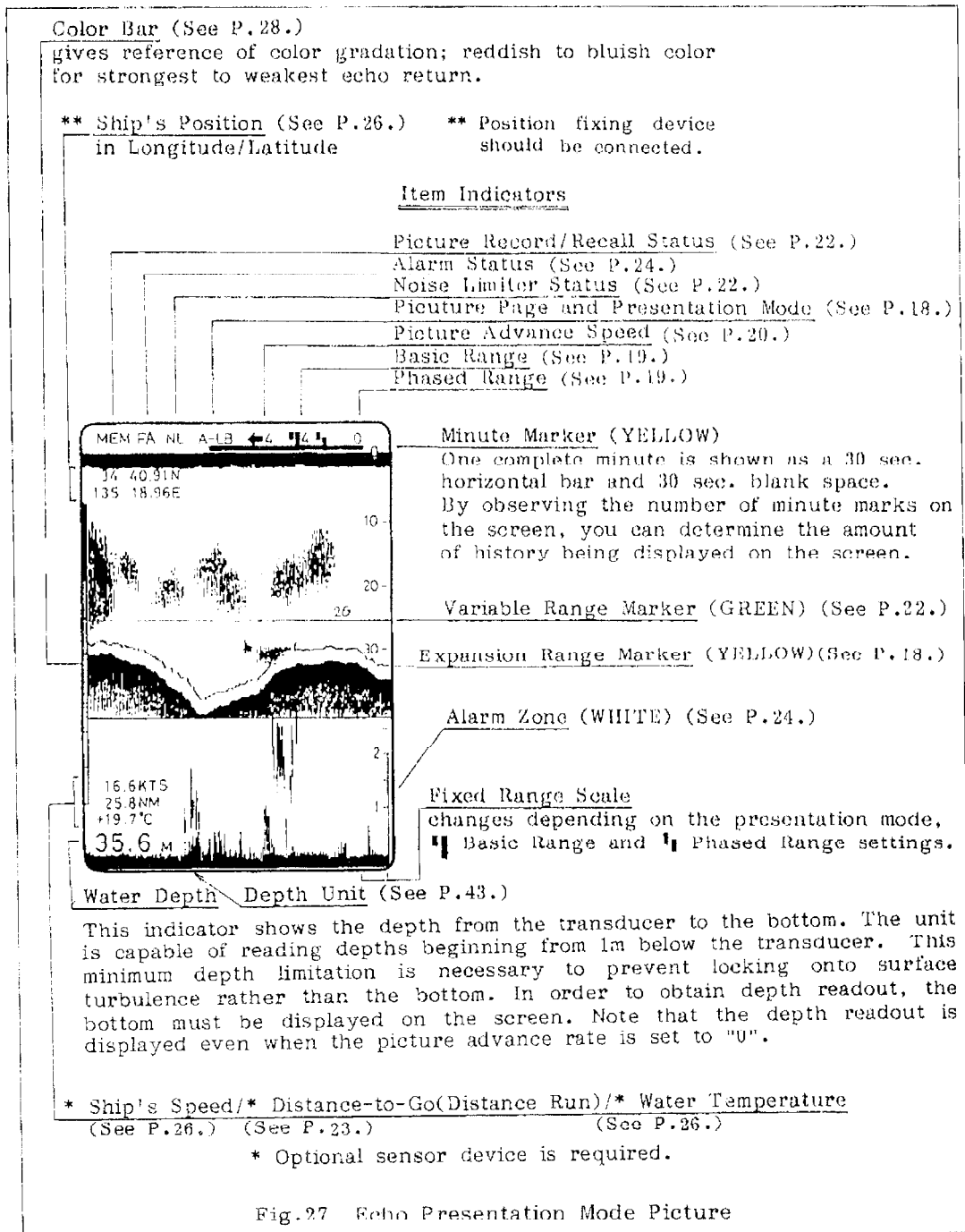

Utilizing Water Temperature Indication

All fish species have their respective habitable water temperature ranges as shown below. By reading the water temperature indication, you can know if the water suits the fish you are aiming for. If the temperature is far out of the range, you can hardly expect a good catch.

It is also well known that current rips, caused along sea streams/currents or at their junction, often gather dense fish schools. This rip can be found by watching for ripples or coloration of sea surface, or by observing DSL (plankton layer) on the echo display. However, it is more reliable and easier to detect it by sudden changes of water temperature on the graphic data logging mode.

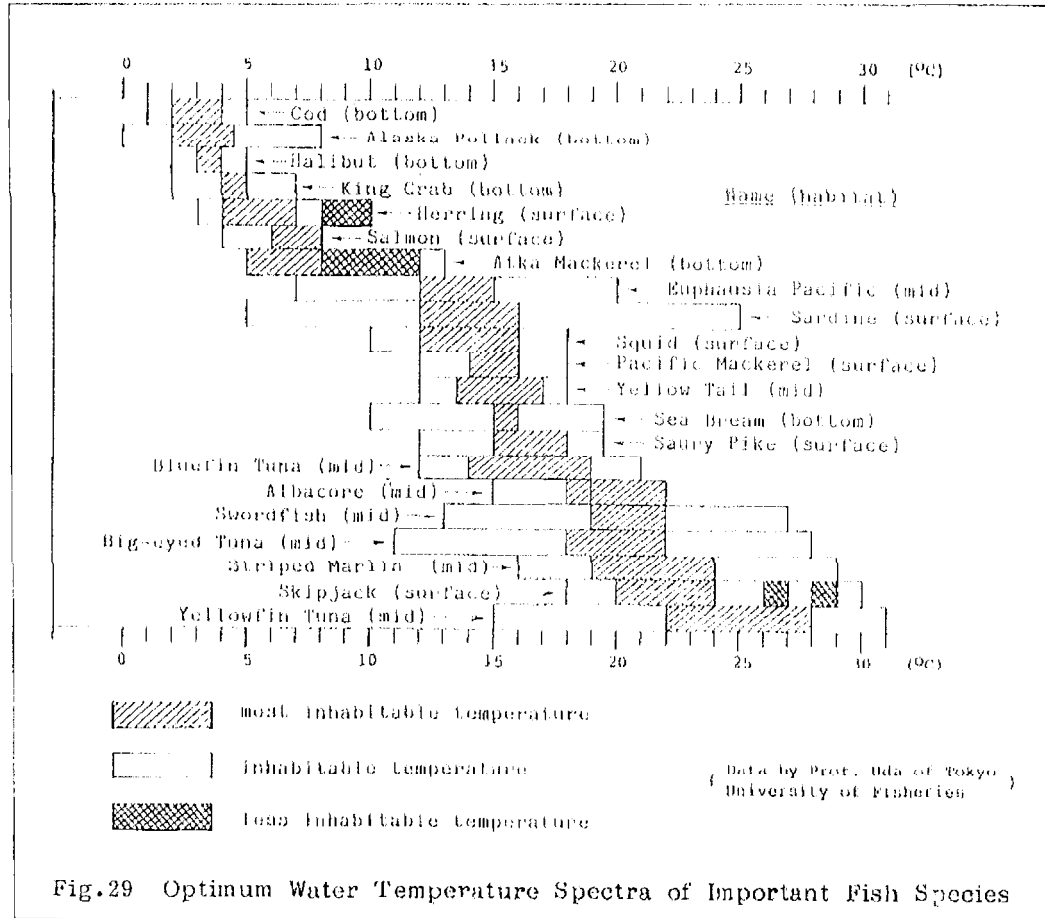

NOTE: 1. For water temperature indication, an optional sensor device is required.

2. The temperature indicated is measured by the sensor installed on the ship's hull, not the temperature at midwater or at the seabed.

INTERPRETING THE DISPLAY

As mentioned before both fish echoes and bottom contour echoes are composed of a series of vertical scan lines moving right to left across the screen. It is possible for the same object to be recorded on the display in a variety of shapes depending on the distance to the object, the angle at which the fish is struck by the transmitted pulse, echo strength, etc.

DETECTING AREA

The detecting area varies depending on the main beamwidth of the transducer, as shown below. Objects out of the main beam but close to the beam will be presented less densely, smaller in size, and at a lower intensity.

With the FCV-662, the operator has the choice of either 50kHz or 200kHz operation. There are advantages and disadvantages to both frequencies and you should select the frequency best suited to your needs.

Generally, beamwidth depends on transmission frequency; a narrower beamwidth is usually obtained at the higher frequency. For example, the 200 kHz transducer has a "-3 dB" beamwidth of approximately 10 degrees, whereas the 50 kHz transducer has a beamwidth of approximately 46 degrees.

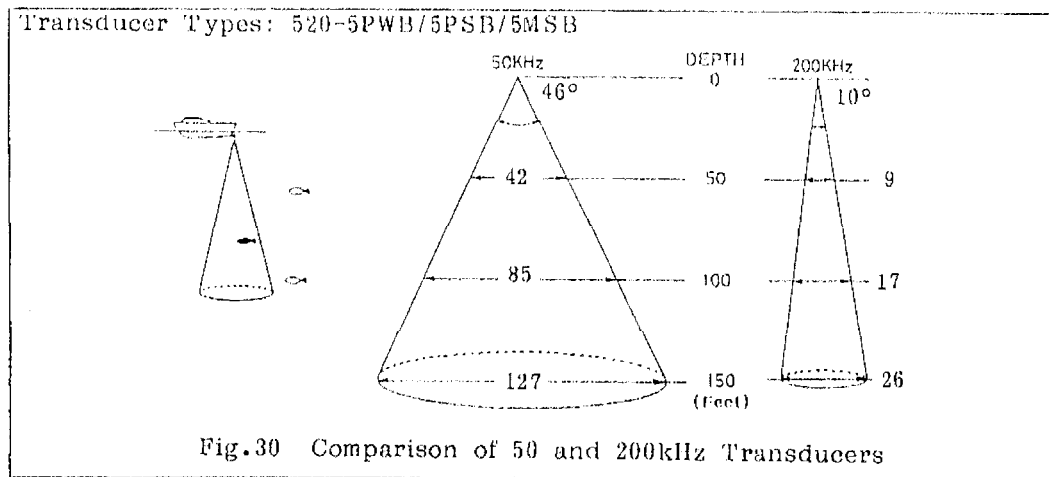

Because the beamwidth of the 200kHz transducer is narrow, the operator has the advantage of higher resolution. In addition, the effects of cruising noise and air bubbles are greatly reduced, since air bubbles resonate at a frequency between 15 and 100kHz. On the minus side, a narrow beamwidth transducer will display even the smoothest bottom contour in a sawtooth pattern if the boat is moving up and down due to pitching and rolling of the boat.

This makes discrimination of fish down close to the bottom difficult. Also, because of the limited coverage area, a narrow beamwidth tends to overlook catchable fish at the sides of the boat. (The maximum percent of depth covered on the bottom for the 200kHz transducer is 17% of the depth. For example, if the bottom depth is 300 feet, the diameter of the coverage circle on the bottom would be only 52 feet.)

ZERO LINE

The zero line (sometimes referred to as the transmission line) represents the transducer's position, and moves off the screen when a deep phased range is used.

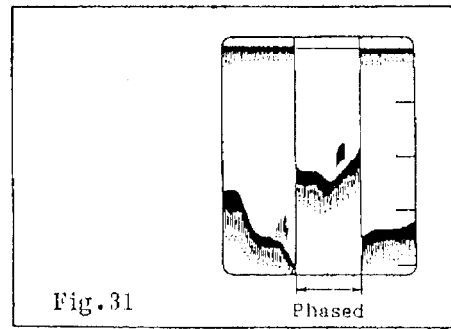

FISH SCHOOL ECHOES

Fish school echoes will generally be plotted between the zero line and the bottom. Usually the fish school/fish echo is weaker than the bottom echo because the reflection surface and the reflection property are much smaller than compared to the bottom. The size of the fish school can be ascertained from the density of the display.

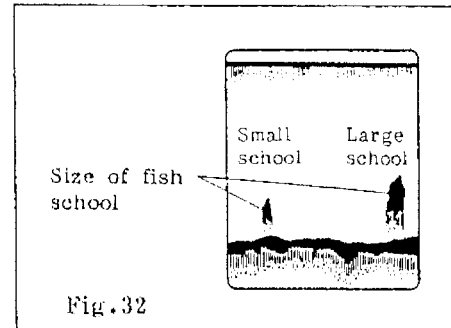

BOTTOM ECHO

Echoes from the bottom are normally the strongest and are displayed in the reddish brown color but the color and width will vary with bottom composition, water depth, frequency, sensitivity, etc.

In a comparatively shallow depth, a high gain setting and a strong bottom echo will cause a second or sometimes a third or a fourth echo to be displayed at the same interval between them below the first echo trace. This is because the echo travels between the bottom and the surface twice or more in shallow depths.

The color of the bottom echo can be used to help determine the density of the bottom material (soft or hard). The harder the bottom, the wider the trace. If the gain is set to show only a single bottom echo on mud, rocky bottom will show a second or third bottom return. The Basic Range chosen should be set to show the first and second bottom echoes when bottom hardness is being determined.

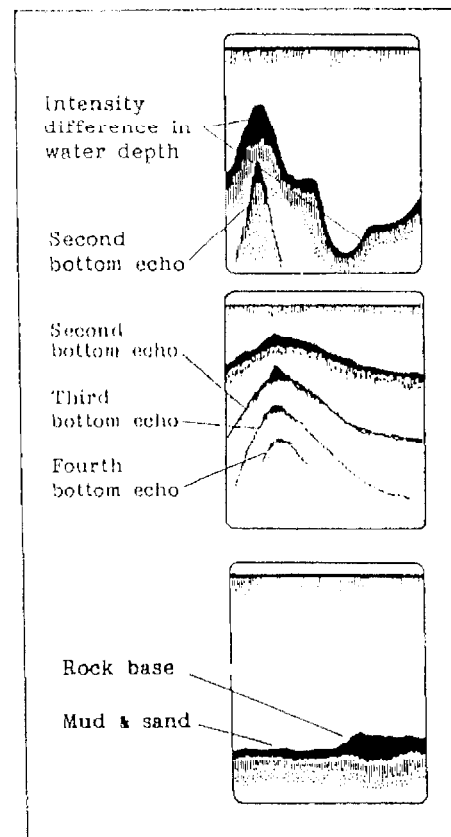

In rough waters the bottom is recorded in a zig-zag pattern, similar to the teeth of a saw. This is caused by the heavy pitching and rolling of the boat, causing the sounding direction to fluctuate and the distance to the bottom to vary.

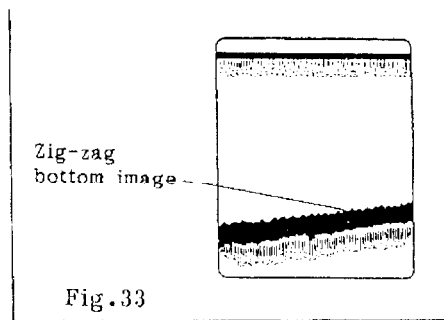

SURFACE NOISE/AERATION

When the waters are rough or the boat passes over a wake, surface noise may appear near the zero line. As surface turbulence is acoustically equivalent to running into a brick wall, the bottom echo will be displayed intermittently. Similar noise sometimes appears when a water temperature difference (thermo-cline) exists. Different species of fish tend to prefer different temperature zones, so thermo-cline information may be useful to help identify target fish. 200KHz tends to show shallow thermo-clines better than 50KHz.

In rough waters the display is occasionally interrupted due to below-the-ship air bubbles obstructing the sound path. This also occurs when the boat makes a quick turn or reverses movement. Lowering the picture advance speed may reduce the interruption. However, reconsideration of the transducer installation may be necessary if the interruption occurs frequently.

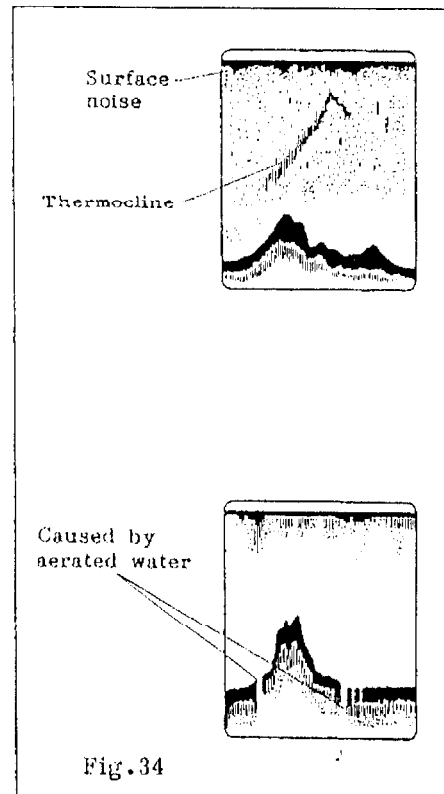

MAINTENANCE

GENERAL

The equipment will maintain optimum performance for a long period. However, continued performance cannot be expected without periodic inspection and maintenance. Important points to be checked from time to time are tabulated below.

Check Item	Action
Cable run	If cut, repair it.
Power cable plug/ transducer cable plug	If loosened, secure it firmly.
Display unit grounding	If corroded, clean it.
Switch knobs	If loosened, secure firmly.
Ship's main voltage	If out of ratings, correct problem.

FUSE REPLACEMENT

To protect the equipment from serious damage, a fuse is provided on the power cable, as illustrated. The fuse protects against overvoltage/reverse polarity of the ship's mains or internal fault of the equipment. If the fuse has blown, first find the cause of the problem before replacing it with a new one. A fuse rated for more than 3A should not be used, since it may cause serious damage to the equipment.

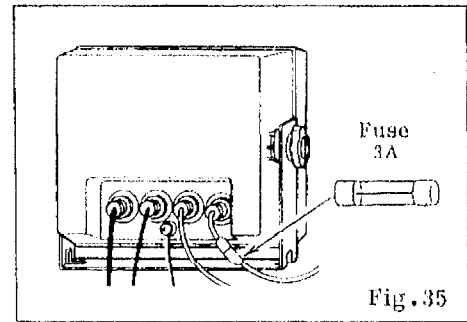

CLEANING AND LUBRICATION

Keep the equipment clean and dry at all times. Dust or loose dirt should be wiped off with a soft, dry cloth. To remove heavy dirt, use mild detergent and water on a cotton tipped swab or soft cloth.

CAUTION

Never apply plastic solvent, such as thinner or acetone, for cleaning and lubrication. It may dissolve paint coating/markings on the front panel.

MAINTENANCE OF THE TRANSDUCER

Underwater growth on the transducer face will result in a gradual decrease in the sensitivity. Check the transducer face each time the boat is drydocked. If any barnacles or seaweed growth is found, remove them very carefully with a piece of wood or sandpaper, taking care not to damage the transducer face.

TROUBLESHOOTING

In this section, troubleshooting is arranged in two parts: one for the user and the other for the service shop. "Basic troubleshooting for user" includes simple tests of the equipment which the user can handle, such as operation, installation and visual checks. The "More extensive troubleshooting for the service shop" is considerably more complicated and must be done by a qualified serviceman. If something appears wrong with your unit, check the equipment referring to the "Basic troubleshooting for user". In case the trouble isn't found after performing these checks, and the unit still appears faulty, call your electronics technician for service.

BASIC TROUBLESHOOTING FOR USER

Note that the number listed on each possible cause corresponds to that of the illustration on the next page.

--- Neither echo nor fixed range scale ---	
* Is the battery dead?	1
* Is the fuse blown?	2
Supply voltage is normal?	
* Corrosion on battery terminal?	1
* Poor contact of power cable?	1

--- No echo but fixed range scale shows ---	
* Is the picture advance rate set to "0"?	3
* Transducer plug is loose?	4

--- Echo appears but no zero line ---	
* Is the range phasing operative?	5

--- Low sensitivity ---	
* Is the GAIN setting too low?	6
* Air bubble or underwater growth (barnacle, seaweed, etc.) attached to the transducer face?	7
* Highly sedimented water?	8
* Soft bottom?	9

--- No water depth readout ---	
* Bottom echo is not painted in reddish brown?	6
* Bottom is not displayed on the screen?	10

--- Heavy noise or interference ---	
* Is the transducer/cable located too near the engine?	11
* Is the unit grounded?	12
* Are other echo sounders of the same frequency operating nearby? ...	13

No or unrealistic speed/temperature indications	
* Sensor plug is loose?	14
No or unrealistic ship's position indication	
* Plug for the position fixing equipment is loose?	15
* The position fixing equipment itself is operating normally?	16

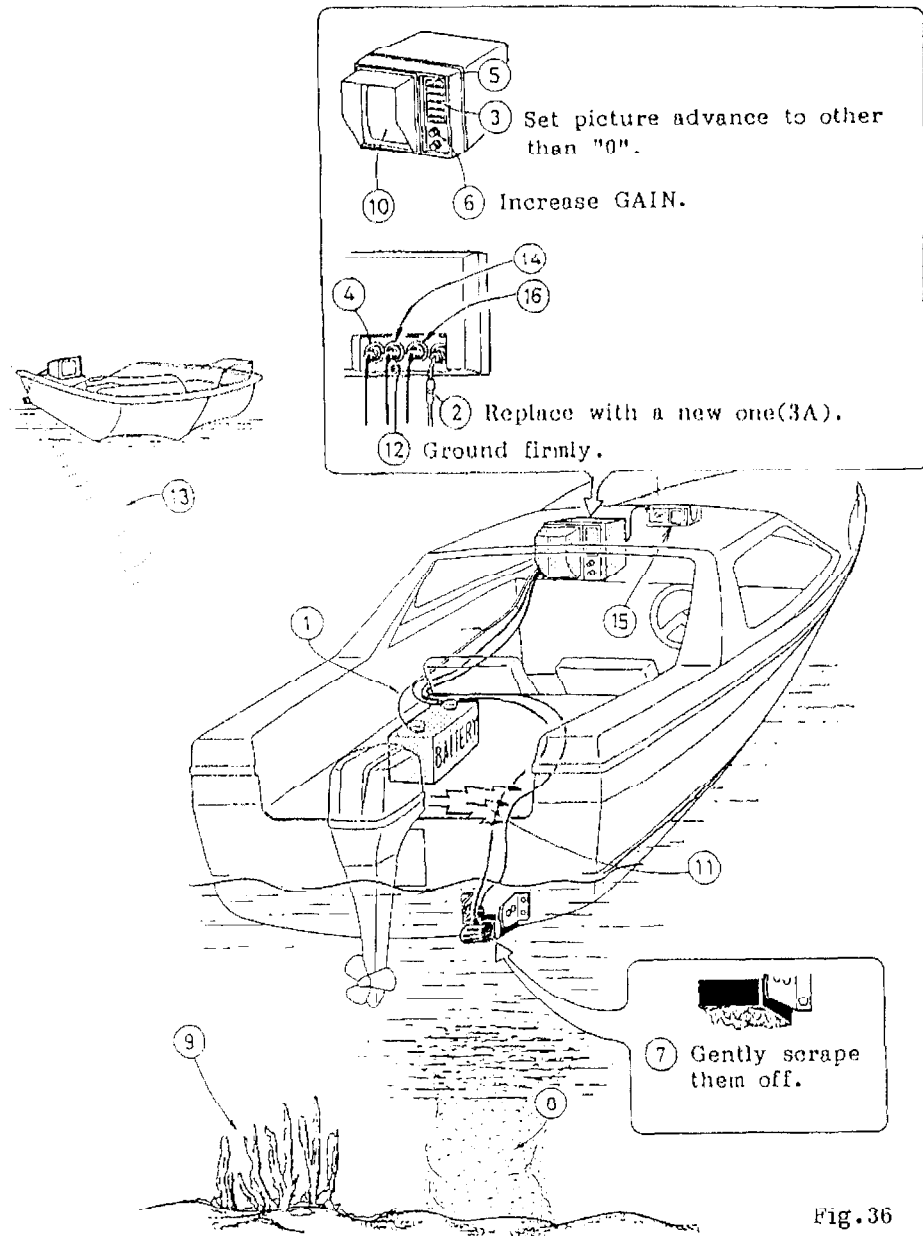

Fig.36

- ⑪ Try to mount a large electrolytic capacitor right at the output terminals of the alternator as close as possible. The capacitor must be rated for the nominal output voltage of the alternator, plus a 50 % safety factor and capacity should be about 10,000 microfarads or so. The positive lead of the capacitor is connected to the output terminal of the alternator in parallel with the heavy lead going to the battery bank. The negative terminal of the capacitor should go to a mounting bolt used to secure the alternator to its mounting frame. Be careful to observe polarity of the capacitor. Reverse polarity will destroy the capacitor, and could damage the charging system as well.

Note that do not connect the capacitor to the field terminal of the alternator, at the risk of destroying the alternator itself.

MORE EXTENSIVE TROUBLESHOOTING FOR THE SERVICE SHOP

The FCV-662 incorporates diagnostic self-check facilities, enabling a service technician to find a faulty pc board. If no trouble is found thru the "Basic troubleshooting for user", perform the following self-checks and voltage/waveform checks.

The self-check may be initiated by turning on the POWER switch while pressing any touchpad on the front panel. In a few seconds the check results will appear on the screen.

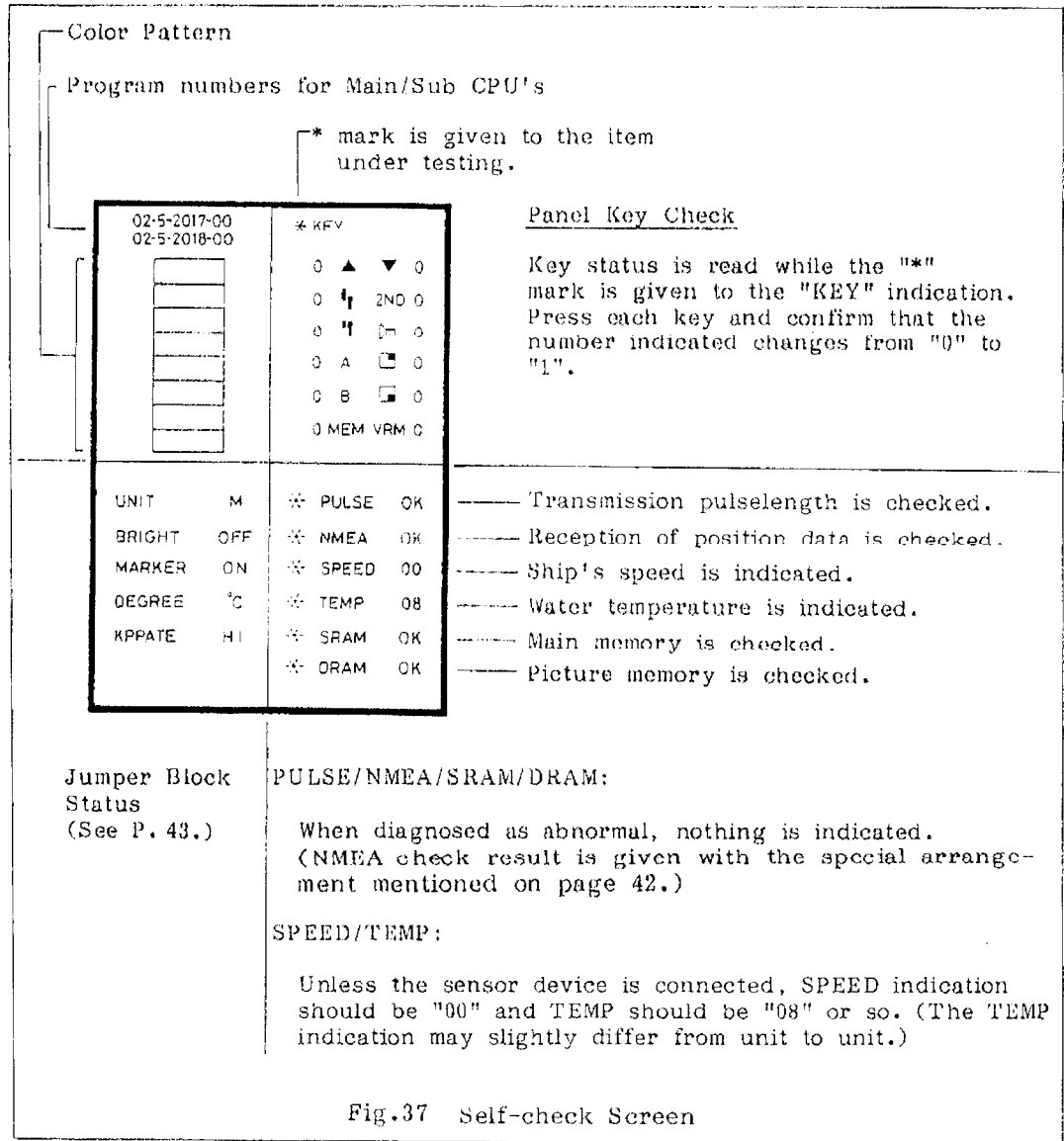
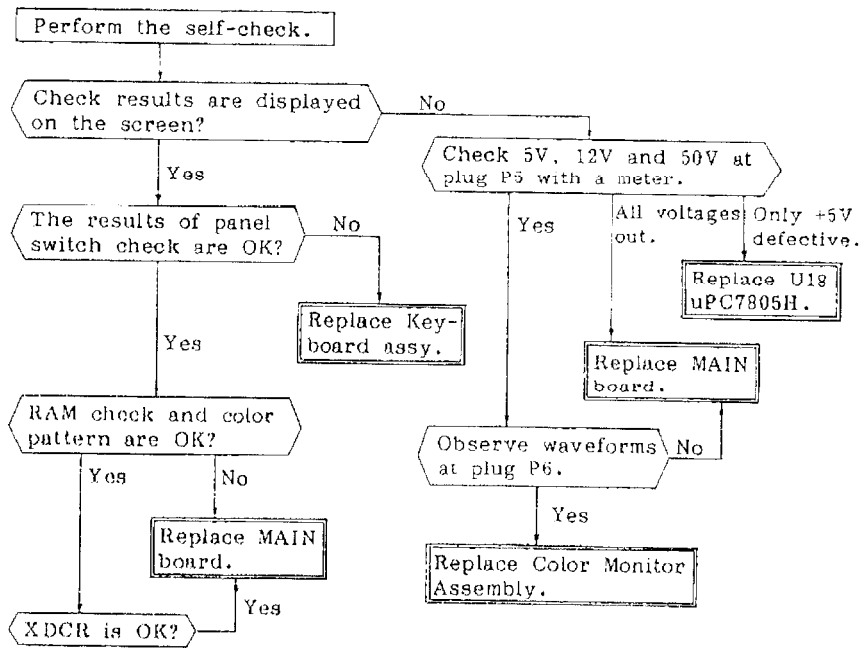

Fig.37 Self-check Screen

As soon as DRAM check starts, entire area of the screen is painted in red and then in white. This process is repeated four times. When DRAM has been checked up, the check result appears on the screen.



Voltages at plug P5

Pin no.	Ratings
2	+4.3V to +5.7V
4	+11.5V to +12.5V
6	+40V to +60V (+70V in the check mode)

Waveforms at plug P6

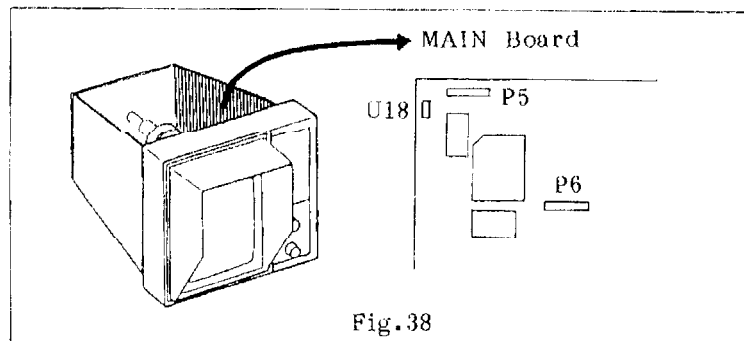
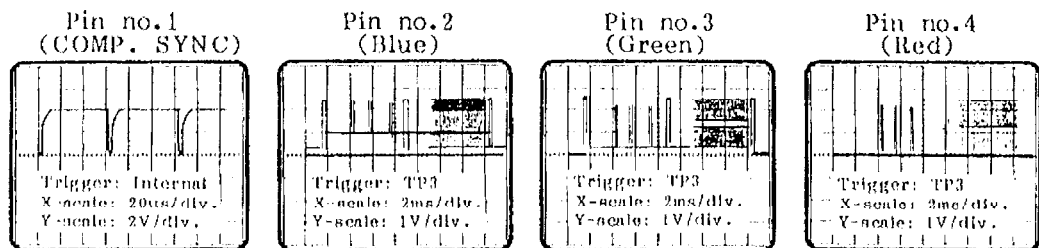

TRANSDUCER CHECK

A simple and reliable check of the transducer is to temporarily substitute a new transducer instead of the existing one to the Display Unit. If the picture sensitivity is considerably improved through this exchange, the transducer is considered to be faulty. On the contrary, if no differences are found, the Display Unit may be faulty. This method is especially useful for inside-hull or through-hull installation.

The following quick check also helps to judge the performance of the transducer to some extent.

Haul the transducer from the water and turn on the POWER. Put your ear near the transducer face and carefully listen to the transmission sound. If you can hear a clicking sound, the transducer probably is OK. Next, rub the transducer face with your hand and observe whether any noise appears on the screen. The appearance of noise indicates that the transducer is normal. In case of neither sound nor noise, the transducer is likely to be faulty.

SPEED/TEMPERATURE SENSOR CHECK

The idea of transducer check can apply to this case, too; temporarily substitute a new sensor instead of the existing one to the Display Unit. If the speed/temperature indications become normal through this exchange, the sensor is considered to be faulty.

Unless a new sensor is available, try the following checks.

First, unplug the sensor connector from the display rear panel, and conduct Self-check (see page 39). If the speed is indicated "00" and the temperature indicate "07" or around, the display unit will be alright. See Fig.39(a).

Next, return to the normal operating mode, and turn the water wheel with a finger. If the sensor is normal, the speed indication will be 2 to 3 knots when the wheel is turned at a normal speed and will be 7 to 8 knots when turned more quickly. As for the temperature, the reading should change when you touch the thermosensor as shown in Fig.39(b).

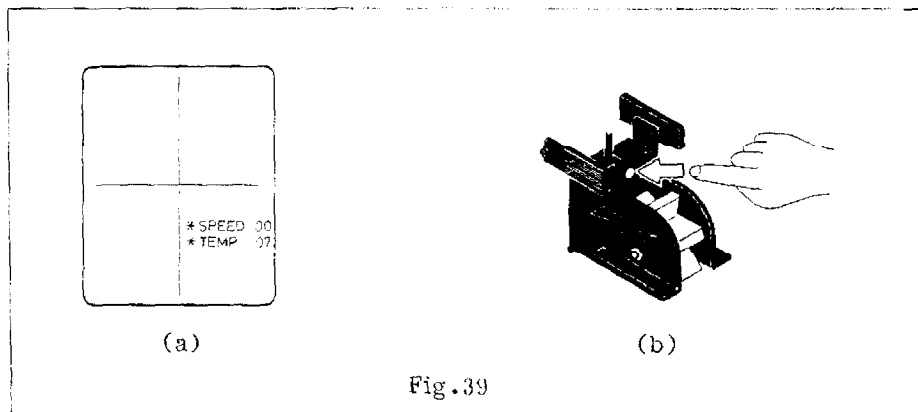

SERIAL COMMUNICATION INTERFACE CHECK

When the ship's position indication is thought to be abnormal, the following loop-back test will instantly judge which unit is faulty, the video sounder or the position fixing equipment.

After turning off the display unit, remove the plug from the jack J2 on the MAIN pc board and strap two pieces of jumper leads on J2 as shown below. Connect the speed/temperature sensor to the display unit if removed. Now, the transmission output port of the built-in interface is coupled to the own reception input port for loop-back test.

Conduct the self-check (see page 39), and be certain that "NMEA OK" is indicated. If so, the display unit is OK, and a fault will exist in the position fixing equipment or in the connection cable.

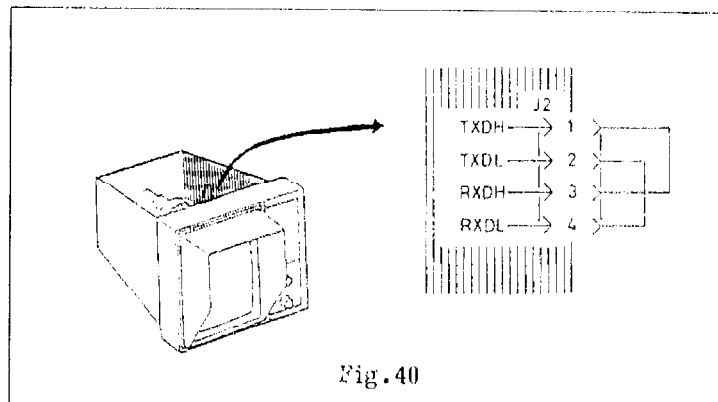

HOW TO CHANGE AND ADJUST INTERNAL SETTINGS

CHANGE OF SPECIFICATIONS

Six jumper blocks are provided on the MAIN board to allow custom tailoring of the unit to specific uses, such as fishing method, fishing ground, etc. To change the settings; (1) turn off the POWER, (2) remove the cover and (3) move the jumper blocks with a needle-nose plier as shown below.

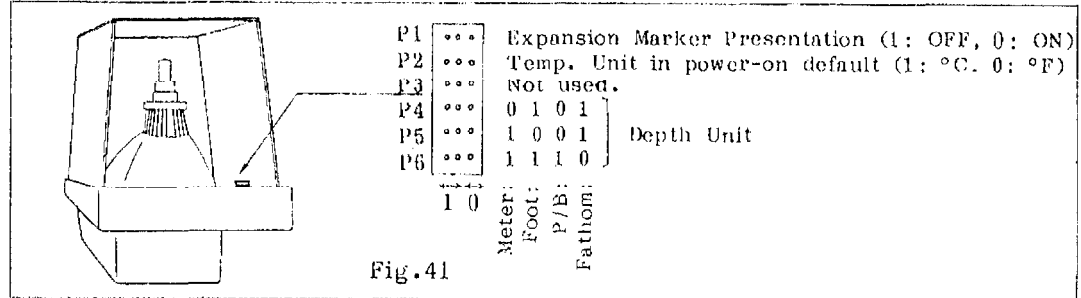

ADJUSTMENT OF PICTURE

CAUTION

Do not change the settings of the centering magnets and the potentiometers on the CRT neck and its p.c. board, respectively.

No adjustment is normally required in the field. However after replacing the TV board with a new one, perform the following adjustment for the picture by means of the crosshatch pattern displayed in the self-check mode.

Note: Since the position of the CRT is shifted by 90 degrees, "V" and "H" indications on the TV board correspond to "Horizontal" and "Vertical", respectively.

Horizontal Position

Turn the H.POS potentiometer so that the corners of the cross hatch pattern (hereafter just called "pattern") are completely displayed on the screen.

Vertical Synchronization

Adjust the H-HOLD coil to the point where the pattern becomes stable in the vertical direction.

Horizontal Synchronization

Perform the same procedure as "Vertical Synchronization" by turning the V-HOLD potentiometer to stabilize the pattern in the horizontal direction.

Horizontal Size

Turn the V-SIZE potentiometer so that the pattern reaches to the left and right edges of the screen.

Vertical Size

Turn the H-SIZE coil so that the pattern reaches to the upper and lower edges of the screen.

Contrast

Turn the  Brilliance control fully CW, and adjust the SCREEN potentiometer so that the fly-back lines colored white just disappear. Next, turn the control fully CCW, and confirm that the strongest color, i.e., reddish brown, can be recognized by observing the color pattern.

Focus

Adjust the FOCUS potentiometer for the sharpest picture.

Vertical Position

Turn the  Brilliance control fully CW, and adjust the H. POS. potentiometer so that the upper and lower blank areas become equal in width.

Color Presentation

Turn the  Brilliance control fully CW, and adjust the BLU and RED potentiometers so that the color pattern is presented with the proper eight colors and the characters, white.

ADJUSTMENT OF TVG

The TVG potentiometer is located on the MAIN board and is set to the position "2" at factory. Turning it clockwise will expand the effective range of the TVG up to 300m for both 50 and 200kHz. If necessary, readjust it so that the surface noise slightly appears on the screen with the GAIN set to the position you normally use.

What is "TVG"

TVG is an abbreviation for Time Varied Gain. The function of the TVG is to compensate for the effect of propagation loss of sound energy; it suppresses the sensitivity of the receiver just after transmission and gradually increases with time, reducing surface noise and providing a clear and uniform display.

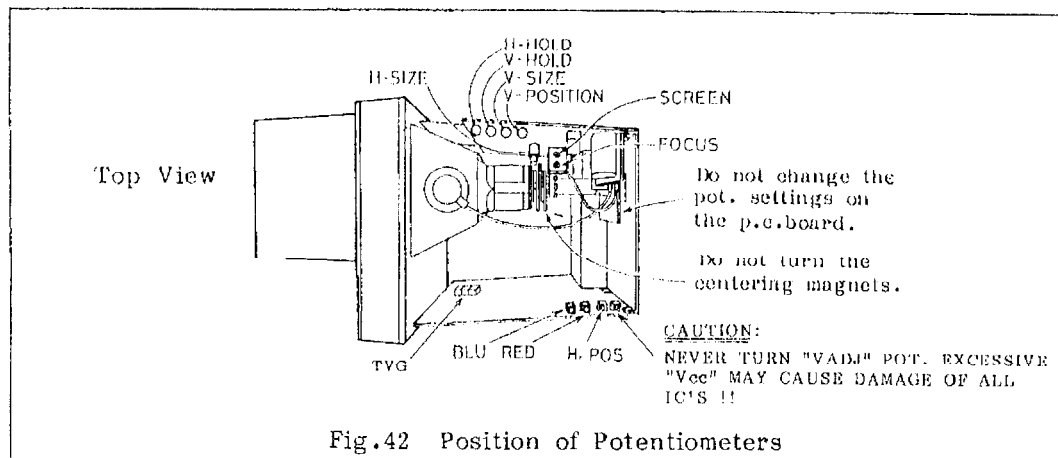

Symbol	Name	Type	Code No.
A101	Viewing Hood Assembly	FP02-00610	000-135-592
A102	Filter	D2-058-1011-	100-033-261
A103	Knob	B-15V	000-103-445
A104	Key Board Assembly	02S3878	000-108-687
A105	Potentiometer Assembly	02P6001	001-359-780
A106	MAIN Board Assembly	A1QADSP08	000-104-914
A107	Color Monitor Assembly		
A108	Connector	22S0016, 3P	000-108-958
A109	Connector	22S0018, 6P	000-108-959
A110	Connector	22S0017, 4P	000-108-513
A111	Connector	22S0015, 2P	000-108-297
A112	Power Cable Assembly	22S0023	000-108-376
A113	LC-9) Connection Cable Assy	OP02-28	000-014-410
A114	Speed/Temperature Sensor	ST-01PTB	000-105-533
		ST-01PSB	000-109-274
		ST-01MSB	000-105-512
		529-5P7B	000-015-017
		533-5P5B	000-015-018
		530-5MSB	000-015-032
A115	Transducer		
A121	Rubber Washer	02-352-1302	100-022-541
A122	Bracket	FP32-00479	001-351-710
A123	Knob Washer	05-012-0125	591-201-251
A124	Knob Bolt	RG-52.33X29	000-200-413

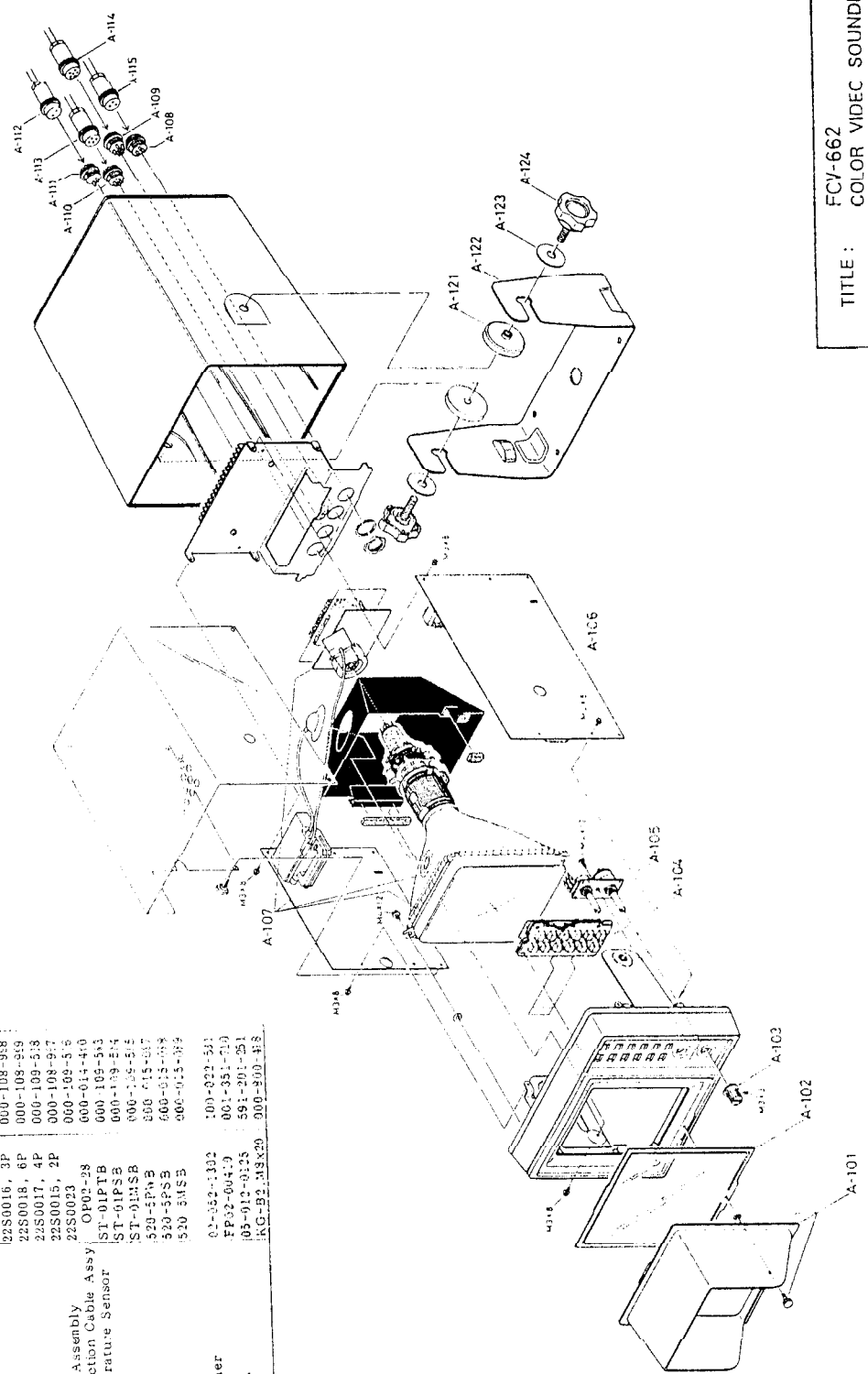

TITLE : FCV-662
COLOR VIDEc SOUNDEF

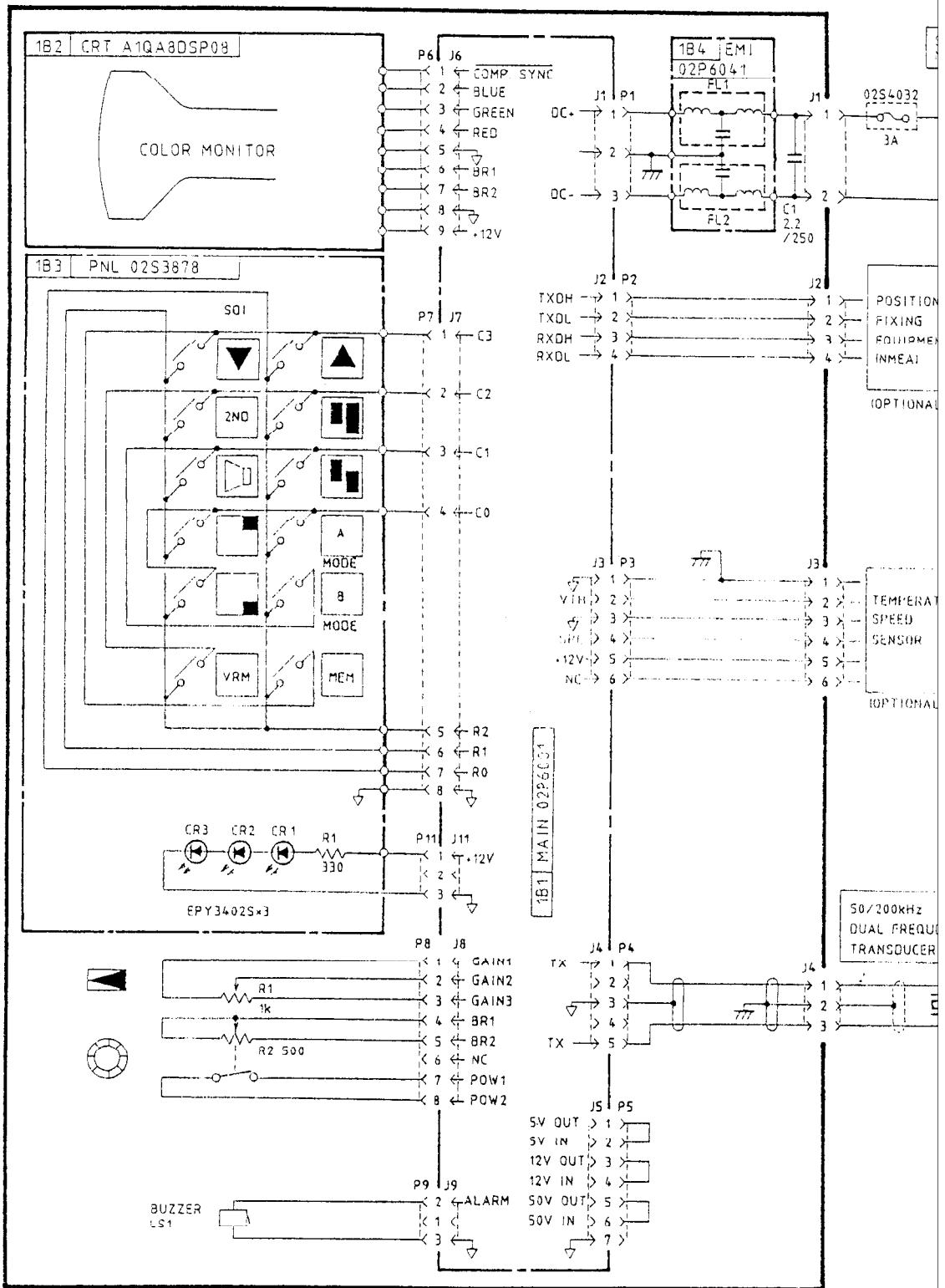

TITLE: FCV-662
 COLOR VIDEO SOUNDER
 DWG. NO. E2303-002-A

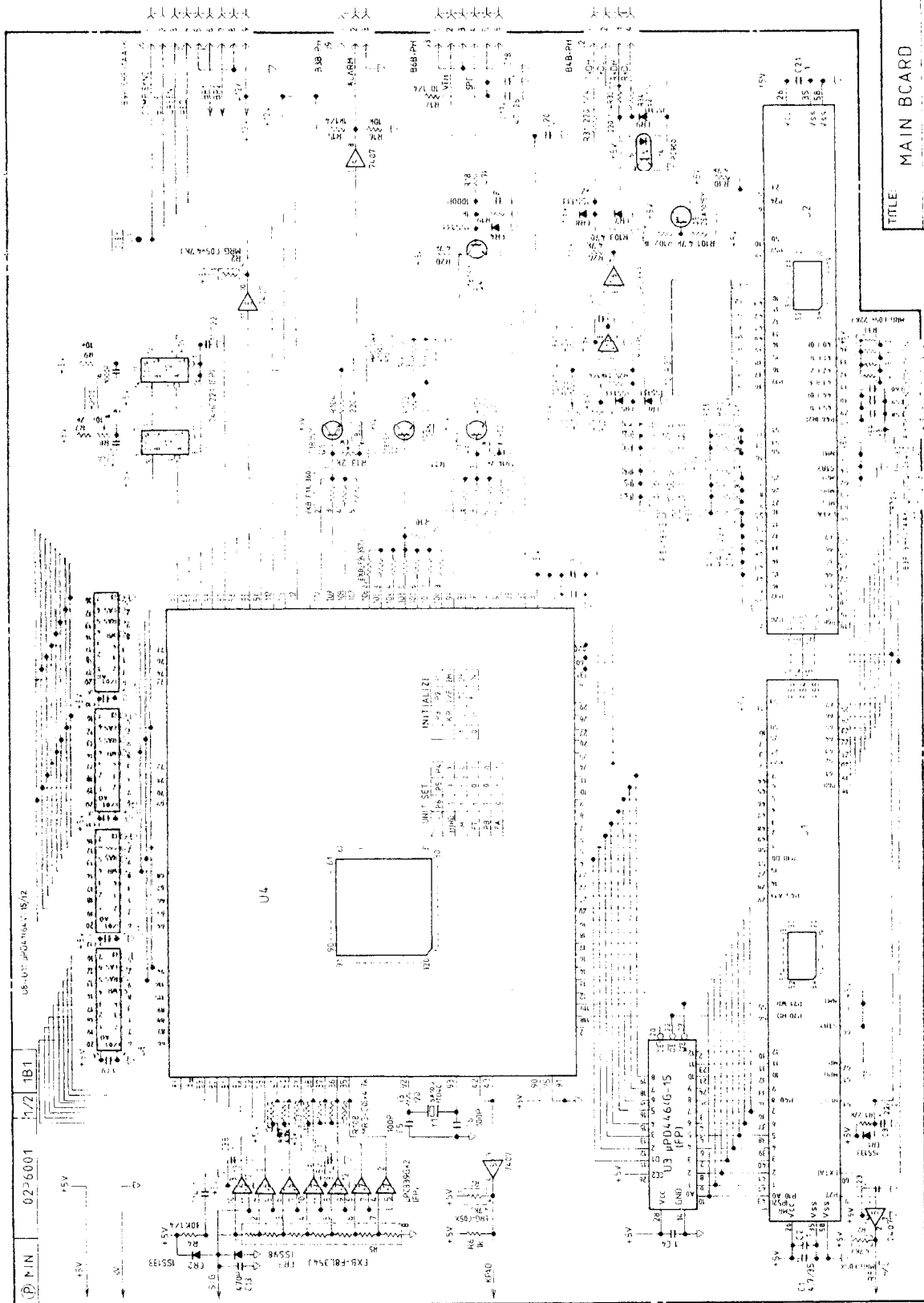

TITLE MAIN BOARD

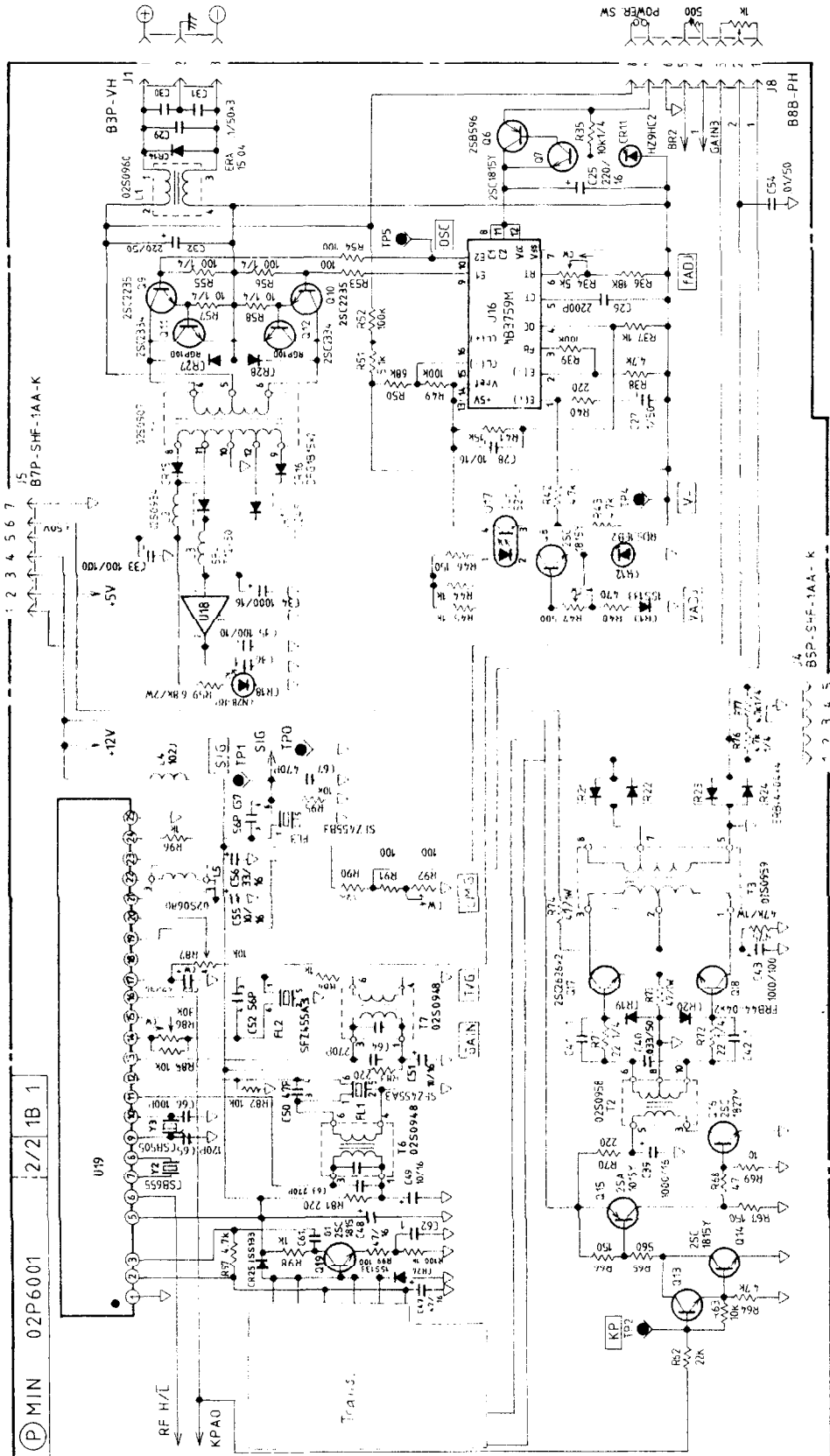

MIN 02P6001 2/2 1B 1

TITLE: MAIN BOARD
 DWG. NO. E2303-004-B

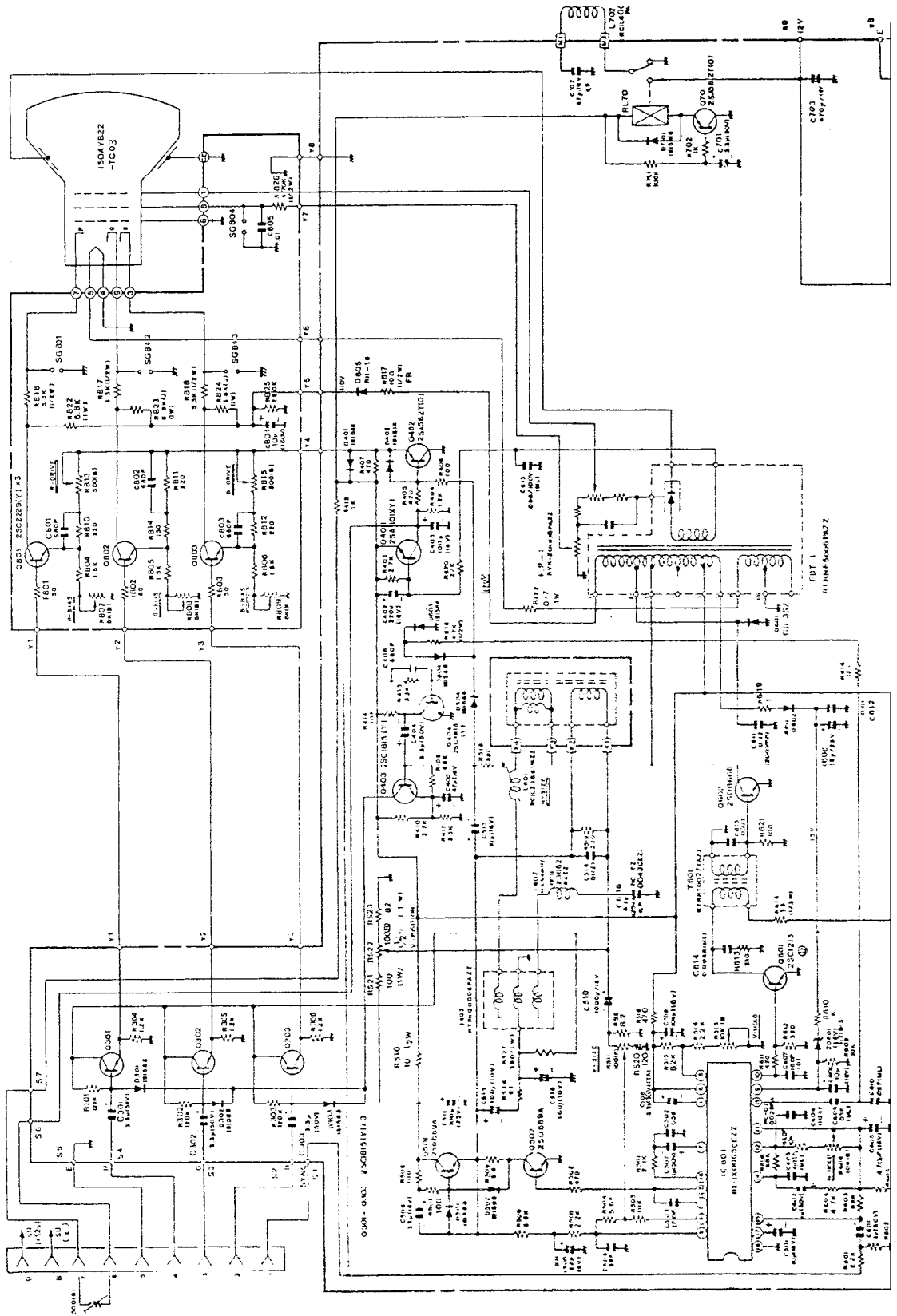

INSTALLATION OF OPTIONAL DEVICES

Mounting Transom Type Transducer using Kick-up Bracket (0P02-29)

When the transducer is mounted extruded from the hull bottom as shown in Fig.3(b) (page 7), it is subject to damage or loss due to floating objects, such as a log.

To minimize such an accident it is recommended to install the transducer, using the optional Kick-up Bracket as shown below. When an impact by the floating object or extraordinary water pressure is added, the transducer will be kicked up and damage or loss will be avoided. It is also a good idea to flip the transducer up when the boat is hauled out of water/put on a trailer.

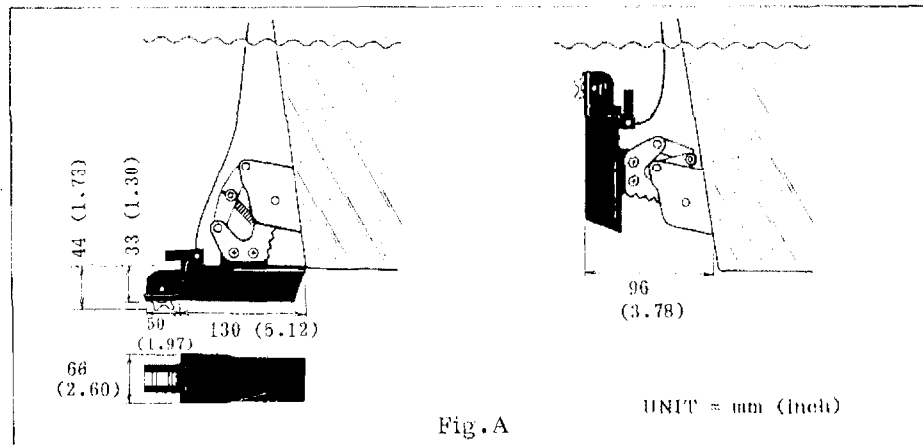

Mounting Transom Type Sensor (ST-01PTB)

(1) When the transom type transducer (520-5PWB) is mounted extruded from the hull bottom as shown in Fig.3(b) (page 7) or is mounted with the kick-up bracket, the sensor can be directly attached to it as show below without using any installation material.

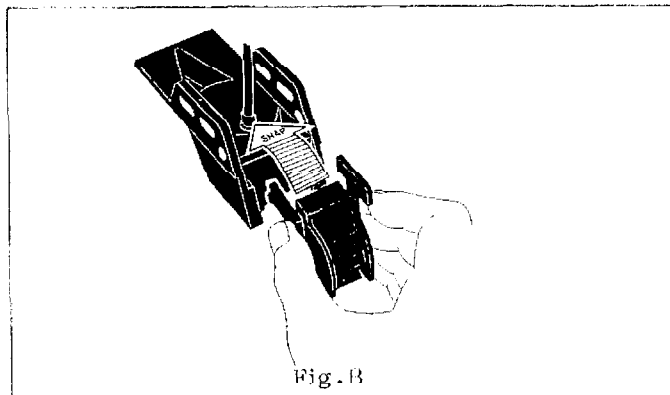

After having connected the sounder to the LC-90, change the output format of the LC-90:

- (1) Press **#** and **3** keys in order to select Function 3, and the formats assigned to Port-1 and Port-2 will be presented as shown right.
- (2) Press **▼** key until the cursor moves down to the intended line.
- (3) Press **CLR** key.
- (4) Press **+/-** key several times until "183" is displayed at the right of the port number.
- (5) Press **ENT** key.

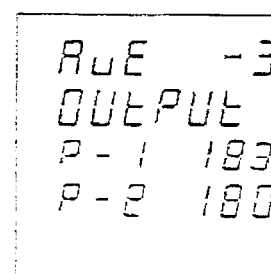

Fig. E

Other Make Position Fixing Equipment with NMEA #0183 Format Output

The LC-90 Connection Kit is also optionally required. But procure a plug the accompany position fixing equipment locally. The wiring is similar to above diagram: connect the yellow and green leads to the SIGNAL and RETURN lines respectively. And ground the shield of the cable with CHASSIS of the equipment.

***** NOTE *****

An input signal exceeding 8V across the SIGNAL and RETURN lines may damage the input circuit of the video sounder. Modification to the input circuit is required locally: remove the 62-ohm carbon resistor (R34) as shown below. By this change, its input impedance changes from 160 ohms to 40 ohms approximately.

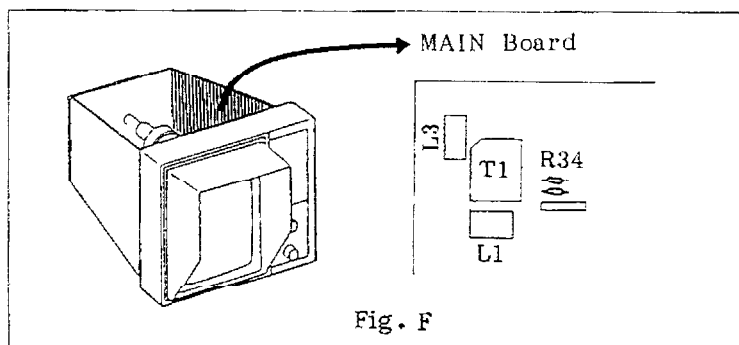

Fig. F