

FURUNO

FISH FINDER

Model **FCV-600/FCV-800**

FURUNO ELECTRIC CO., LTD.

9-52 Ashihara-cho,
Nishinomiya, 662-8580, JAPAN

FURUNO Authorized Distributor/Dealer

All rights reserved. Printed in Japan

A : JAN. 2023
B : MAR. 4, 2024

Pub. No. OME-23940-B

(MENA) FCV-600/800



00019965012



FURUNO ELECTRIC CO., LTD.

www.furuno.com

IMPORTANT NOTICES

General

- This manual has been authored with simplified grammar, to meet the needs of international users.
- The operator of this equipment must read and follow the descriptions in this manual. Wrong operation or maintenance can void the warranty or cause injury.
- Do not copy any part of this manual without written permission from FURUNO.
- If this manual is lost or worn, contact your dealer about replacement.
- The contents of this manual and equipment specifications can change without notice.
- The example screens (or illustrations) shown in this manual can be different from the screens you see on your display. The screens you see depend on your system configuration and equipment settings.
- Save this manual for future reference.
- Any modification of the equipment (including software) by persons not authorized by FURUNO will void the warranty.
- The following concern acts as our importer in Europe, as defined in DECISION No 768/2008/EC.
 - Name: FURUNO EUROPE B.V.
 - Address: Siriusstraat 86, 5015 BT, Tilburg, The Netherlands
- The following concern acts as our importer in UK, as defined in SI 2016/1025 as amended SI 2019/470.
 - Name: FURUNO (UK) LTD.
 - Address: West Building Penner Road Havant Hampshire PO9 1QY, U.K.
- Android, Google and Google Play are registered trademarks of Google Inc.
- Apple is a trademark of Apple Inc., registered in the U.S. and other countries and regions. Apple Store is service mark of Apple Inc.
- All brand and product names, trademarks, registered trademarks, and service marks belong to their respective holders.

How to discard this product

Discard this product according to local regulations for the disposal of industrial waste. For disposal in the USA, see the homepage of the Electronics Industries Alliance (<http://www.eiae.org/>) for the correct method of disposal.

How to discard a used battery

Some FURUNO products have a battery(ies). To see if your product has a battery, see the chapter on Maintenance. If a battery is used, tape + and - terminals of the battery before disposal to prevent fire, heat generation caused by short circuit.

In the European Union

The crossed-out trash can symbol indicates that all types of batteries must not be discarded in standard trash, or at a trash site. Take the used batteries to a battery collection site according to your national legislation and the Batteries Directive 2006/66/EU.

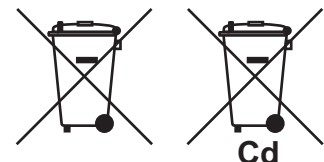

In the USA

The Mobius loop symbol (three chasing arrows) indicates that Ni-Cd and lead-acid rechargeable batteries must be recycled. Take the used batteries to a battery collection site according to local laws.

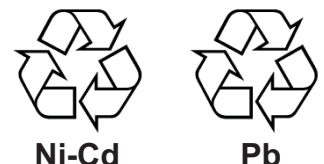

In the other countries

There are no international standards for the battery recycle symbol. The number of symbols can increase when the other countries make their own recycle symbols in the future.



SAFETY INSTRUCTIONS

The operator and installer must read the applicable safety instructions before attempting to operate or install the equipment.



WARNING

Indicates a condition that can cause death or serious injury if not avoided.



CAUTION

Indicates a condition that can cause minor or moderate injury if not avoided.



Warning, Caution



Prohibitive Action



Mandatory Action



WARNING



ELECTRICAL SHOCK HAZARD
Do not open the equipment.

Hazardous voltage exists inside the equipment. Refer repair to authorized service personnel.



Do not disassemble or modify the equipment.

Fire, electrical shock or injury can result.



Immediately turn off the power at the switchboard if the equipment is emitting smoke or fire.

Continued use of the equipment can cause fire or electrical shock. Contact a FURUNO agent for service.



Do not maneuver the vessel based on the depth indication alone.

Grounding can result



Use the proper fuse.

Use of an incorrect fuse can damage the equipment and can cause fire.



CAUTION



Do not turn on the equipment with the transducer out of water.

The transducer can be damaged.



The picture is not refreshed when the picture advance setting is "Off".

Maneuvering the vessel in this condition can result in a dangerous situation.



Adjust the gain correctly.

If the value of the gain setting is too small, weak signals will be suppressed and no indication appears. If the value is too large, noise will fill the screen and the indication will be difficult to distinguish. It is dangerous to use the depth display as a reference when operating the vessel without a clear indication of the seabed.



The LCD panel is made of glass. Handle it with care.

Injury can result if the glass breaks.



Do not use high-pressure cleaners to clean this equipment.

This equipment has the waterproof rating outlined in the specifications, at the back of this manual. However, the use of high-pressure cleaning equipment can cause water ingress, resulting in damage to, or failure of, the equipment.

Warning Label

A warning label is attached to the display unit.
Do not remove the label. If the label is missing
or damaged, contact a FURUNO agent or
dealer about replacement.



Name: Warning Label
Type: 16-021-3517-0
Code No.: 100-350-230-10

The TFT LCD is constructed using the latest LCD techniques, and displays 99.99% of its pixels. The remaining 0.01% of the pixels may drop out or blink, however this is not an indication of malfunction.

TABLE OF CONTENTS

FOREWORD	vi
SYSTEM CONFIGURATION	ix
1. OPERATION	1-1
1.1 Control Description.....	1-1
1.2 Turning The Power On/Off	1-2
1.3 Display Brilliance/Panel Dimmer	1-2
1.4 Display Color Scheme Mode.....	1-3
1.5 Display Mode	1-3
1.5.1 How to change the display mode	1-4
1.5.2 Single frequency display	1-6
1.5.3 Dual frequency display.....	1-6
1.5.4 Zoom displays	1-7
1.5.5 Nav data display.....	1-9
1.5.6 Edit display mode.....	1-9
1.6 How to Select a Range	1-12
1.7 How to Adjust the Gain	1-13
1.8 How to Measure Depth	1-14
1.9 Menu Operating Procedure.....	1-15
1.10 How to Shift the Range	1-16
1.11 Picture Advance Speed.....	1-18
1.12 How to Reduce Interference	1-19
1.13 How to Reduce Low Level Noise	1-20
1.14 How to Erase Weak Echoes	1-20
1.15 A-scope Display	1-21
1.16 Displaying history	1-23
1.17 Fish Information (ACCU-FISH™).....	1-23
1.17.1 How to activate ACCU-FISH™	1-24
1.17.2 Fish symbols	1-24
1.17.3 Fish info.....	1-24
1.17.4 Restrict the fish symbol display.....	1-25
1.18 Bottom Discrimination Display	1-25
1.19 RezBoost™	1-27
1.20 TVG Settings.....	1-28
1.21 Alarms.....	1-28
1.22 FUNC Key.....	1-33
1.22.1 How to open the registered setting window	1-33
1.22.2 How to change the function.....	1-34
1.23 Waypoints	1-34
1.23.1 How to register a waypoint.....	1-34
1.23.2 How to edit registered waypoints	1-37
1.23.3 How to erase waypoints	1-37
1.23.4 How to set destination waypoint.....	1-38
1.24 Setting Up Nav Data Displays.....	1-38
1.25 Wireless LAN setup.....	1-40
1.25.1 Wireless LAN settings on the FCV main unit (main monitor side)	1-40
1.25.2 Wireless LAN settings on the sub monitor side.....	1-44
1.25.3 Wireless LAN settings on the iOS or Android™ device	1-44

1.26 Menu Description.....	1-45
1.26.1 [Sounder] menu.....	1-45
1.26.2 [Display] menu.....	1-48
1.26.3 [Alarm] menu.....	1-50
1.26.4 [Data] menu.....	1-50
2. SYSTEM MENU	2-1
2.1 How to Display the System Menu.....	2-1
2.2 [Range] Menu.....	2-1
2.3 [Key] Menu.....	2-2
2.4 [Language] Menu.....	2-2
2.5 [Units] Menu.....	2-2
2.6 [Network] Menu.....	2-3
2.6.1 [Sensor In Use] window.....	2-3
2.6.2 [Data Source] setting window.....	2-4
2.6.3 [NMEA0183] window (FCV-800 only).....	2-5
2.6.4 [NMEA2000] window.....	2-6
2.7 [Calib] Menu.....	2-7
2.8 [Transducer] Menu.....	2-9
2.9 [Service] Menu.....	2-10
3. MAINTENANCE, TROUBLESHOOTING	3-1
3.1 Maintenance.....	3-1
3.2 How to Replace the Fuse.....	3-2
3.3 Battery Voltage Alert.....	3-2
3.4 Troubleshooting.....	3-3
3.5 Diagnostics.....	3-4
3.6 LCD Test.....	3-6
3.7 Wireless LAN Test.....	3-6
3.8 Restore Factory Default Settings.....	3-8
APPX. 1 MENU TREE	AP-1
APPX. 2 TRANSDUCER LIST	AP-5
APPX. 3 RADIO REGULATORY INFORMATION	AP-7
SPECIFICATIONS	SP-1
INDEX	IN-1

FOREWORD

A Word to FCV-600/800 Owners

Congratulations on your choice of the FURUNO FCV-600/800 Fish Finder. We are confident you will see why the FURUNO name has become synonymous with quality and reliability.

Since 1948, FURUNO Electric Company has enjoyed an enviable reputation for innovative and dependable marine electronics equipment. This dedication to excellence is furthered by our extensive global network of agents and dealers.

This equipment is designed and constructed to meet the rigorous demands of the marine environment. However, no machine can perform its intended function unless operated and maintained properly. Please carefully read and follow the recommended procedures for operation and maintenance. We would appreciate hearing from you, the end user, about whether we are achieving our purposes.

Thank you for considering and purchasing FURUNO equipment.

Features

The FURUNO FCV-600 and FCV-800 are Fish Finders compatible with CW and CHIRP transducers. Comprised of a main unit and a transducer (option), the FCV-600 and FCV-800 show underwater conditions on a color LCD, 5.7 inch (FCV-600) or 8.4 inch (FCV-800).

The main features of the FCV-600/800 are

- Bright color LCD gives excellent readability even in broad daylight.
- CW/CHIRP simultaneous transmission when two desired transducers are connected (FCV-800 only).
- Support for smartphone/ tablet usage.

Use the dedicated application software*1 for smartphone/tablet as shown below.

Application	Description	iOS	Android
NavNet Viewer	To check FCV-600/800 fishfinder display data and navigation information. Can also be used for operation of FCV-600/800 (TZ iBoat only).	×	✓
TZ iBoat*2		✓	×

*1: Available as a free download from Apple's App Store (for iOS) or Google Inc. Google Play™ (for Android™).

*2: A separate fee is required to connect FCV-600/800.

- The FCV main unit can be used as a sub monitor (wireless LAN connection between FCV-600 or FCV-800 is required).
- Automatic mode automatically adjusts settings to provide the best possible display, from shallow to deep depths.
- ACCU-FISH™ provides estimate of fish length with fish size dependent fish mark.
- Bottom discrimination display provides estimate of bottom composition.
- RezBoost™ raises echo resolution to see fish echoes clearly.
- Scroll back mode provides to see the past fish echo.

- Heave sensor function provide to show continuously stable echo display (requires connection to Satellite Compass™).
- Full-screen display available for bottom lock and bottom zoom.
- White line feature helps distinguish bottom fish from the bottom echo.
- Destination waypoint (up to 20 waypoints).*
- Echo position can be output to a navigational plotter.*

*Requires connection of appropriate sensor, navigation device.

USB Flash Memory Usage

- Do not use a USB flash memory with security features.
- When a USB flash memory is inserted, it should not be exposed to water. After removing the USB port cover the USB port will no longer be waterproof.
- The following table shows the USB flash memory types that have been tested and are compatible for operation with this device.

Maker	Type
KIOXIA	KLU301A032G
I-O Data	U3-PSH32G/B
BUFFALO	RUF3-KS32GA-BK/N
Transcend	TS32GJF700
SanDisk	SDCZ48-032G-JA57
Lexar	LJDE32C032G-BNQEJ
Kexin	U305-BUGWR*2-32GB
Samsung Flash Drive USB	MUF-32BE3/CN

Software used in this product

This equipment uses the following open source software.

This product includes software to be licensed under the Apache-2.0 and others.

Please access the following URL for further information:

<https://github.com/RT-Thread/rt-thread/blob/master/LICENSE>

This product includes software to be licensed under the 3-clause BSD license and others.

Please access the following URL for further information:

<https://github.com/altera-opensource/intel-socfpga-hwlib>

This product includes software to be licensed under the 3-clause BSD license and “This software may only be used to run on Altera products, or to program Altera devices”, and others.

Please access the following URL for further information:

<https://github.com/cambridgehackers/Altera-SoCFPGA-HardwareLib-MPL>

Program No.

FCV-600: 0252485-02.**

FCV-800: 0252489-02.**

** : denotes minor modifications.

Standards used in this manual

- Key names are shown in boldface type. For example, **MENU/ESC** key.
- Menu items and on-screen indications are shown in brackets. For example, the [Display] menu.
- Messages shown on the screen are enclosed in quotations. For example, "Restart to apply changes".
- The [Day] mode is the default mode for screenshots in this manual. Your colors may be different.
- Most of the screenshots in this manual are taken from the FCV-800. Layouts may be slightly different depending on the connected transducer.

CE/UKCA declaration

With regards to CE/UKCA declarations, please refer to our website (www.furuno.com) for further information about RoHS conformity declarations.

Disclosure of Information about China RoHS

With regards to China RoHS information for our products, please refer to our website (www.furuno.com).

SYSTEM CONFIGURATION

Note 1: See "TRANSDUCER LIST" on page AP-5 for compatible transducers.

FCV-600

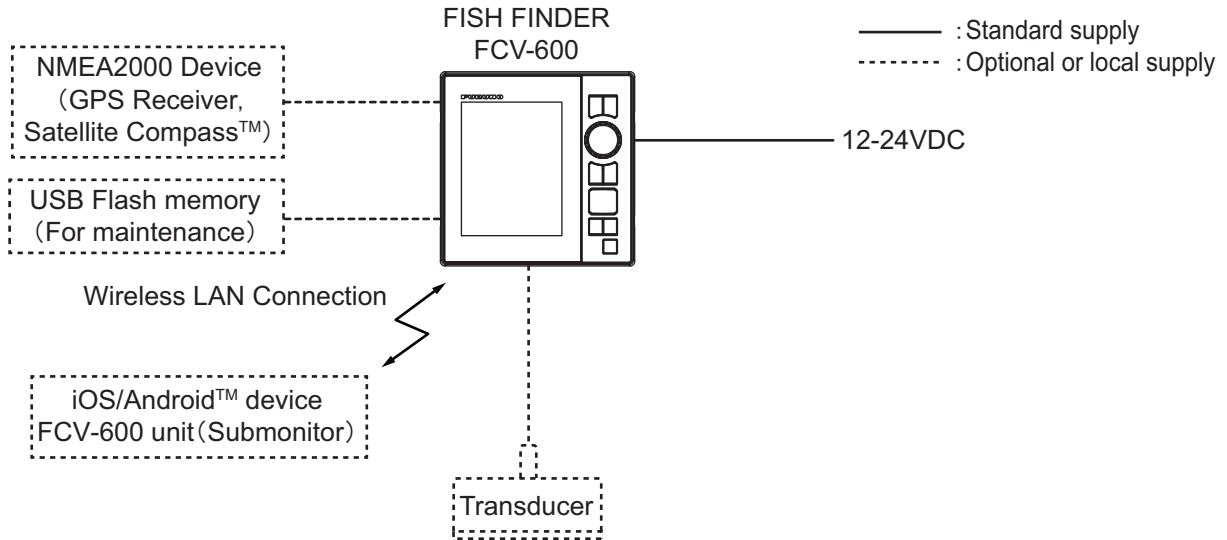

FCV-800

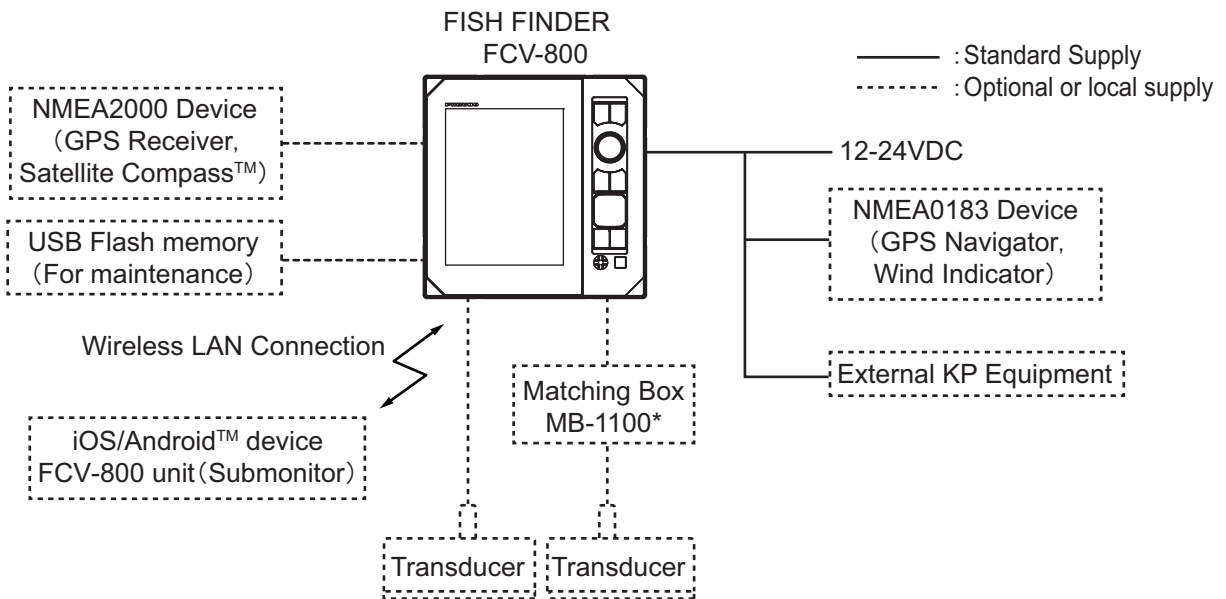

*: Required when 200B-5S, 50B-6, 50B-6B or 50/200-1T is connected only.

Note 2: The optional cable assembly (type: FRU-MJ10CCB12-300) is required for B265LH-FJ12/ TM265LH-FJ12/ CM265LH-FJ12 transducers (FCV-800 only).

This page is intentionally left blank.

1. OPERATION

1.1 Control Description

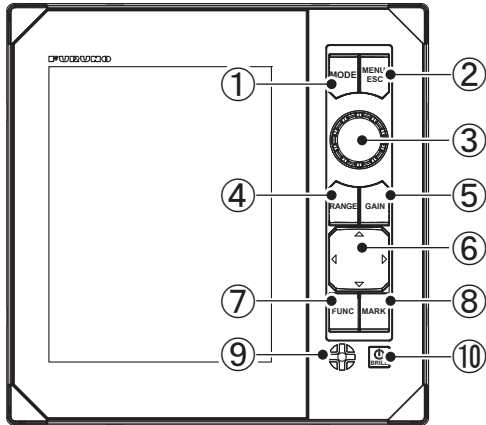

Front side

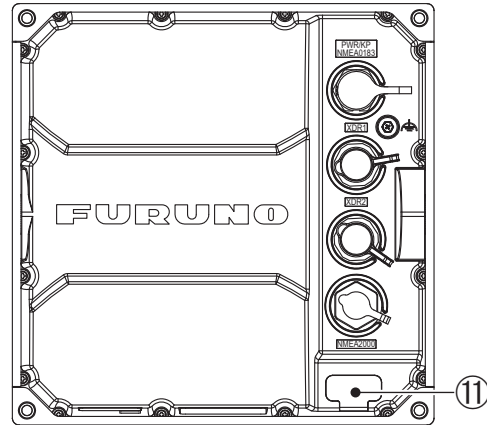

Back side

No.	Control	Function
1	MODE	Opens [MODE] selection window.
2	MENU/ESC	<ul style="list-style-type: none"> Opens/closes the menu. Escapes from current operation and go back one page in menu.
3	KNOB	<p>Rotate*:</p> <ul style="list-style-type: none"> Selects items on the menu. Changes settings. Adjusts gain (Requires [Auto Gain] to be set as [Off].) <p>*: Clockwise: Increases numerical value. Moves the cursor down (or right). Counter-clockwise: Decreases numerical value. Moves the cursor up (or left).</p> <p>Press:</p> <ul style="list-style-type: none"> Confirms the selected menu/operation. Applies the gain adjustment. (Selected by rotating; requires [Auto Gain] to be set as [Off].)
4	RANGE	Opens range selection window.
5	GAIN	Opens [Auto Gain] setting window.
6	▲▼◀▶ (CursorPad)	<ul style="list-style-type: none"> ▲▼◀▶: Moves marker cursor. ▲▼: Moves the VRM (Variable Range Marker). Disabled for nav display. ◀: Switches to scroll back mode. Disabled for nav display.
7	FUNC	<p>Short press: Opens programmed window.</p> <p>Long press: Opens setting window for function key.</p>
8	MARK	Registers waypoint.
9	Buzzer (FCV-800 only)	Activates/deactivates key beeps and alarm sounds.
10	🔌/BRILL	<p>Short press: Turns on power; opens the [Brilliance/Panel Dimmer] adjustment window.</p> <p>Long press: Turns off power.</p>
11	USB port cover	<p>Open the cover and insert USB flash memory.</p> <p>Note: Make sure to close the cover when not used.</p>

How to remove the cover

Pull down on the catch at the bottom of the cover and pull the cover toward you.

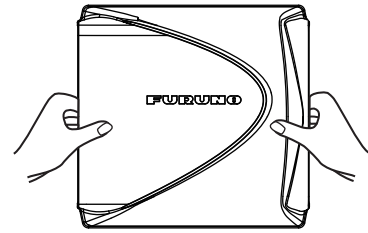

How to cover the connector caps

Cover the connectors that are not used with the supplied connector caps to keep dust out of terminals. The caps are attached to each port on the back of the main unit.

1.2 Turning The Power On/Off

1. Press the  key to turn on the power. The unit beeps then the startup screen appears.



Start-up screen

→ Wait 3-5 seconds, or press any key to show the window that was in use before the power was turned off.

2. To turn off the power, press and hold the  key for more than three seconds. The time remaining until the power is turned off is counted down on the screen.

1.3 Display Brilliance/Panel Dimmer

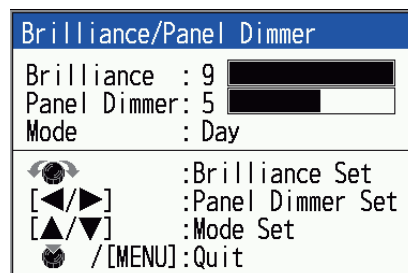

1. Press the  key to show the [Brilliance/ Panel Dimmer] adjustment window. The window automatically closes if there is no key operation for approx. six seconds.



2. Adjust the brilliance/panel dimmer.
 - **Brilliance:** Rotate the **KNOB** or press the  key (setting range: 0 to 9).
 - **Panel Dimmer:** Use ◀ or ▶ to adjust the panel dimmer (setting range: 0 to 9).
3. Press the **KNOB** or **MENU/ESC** key to close the window.

1.4 Display Color Scheme Mode

The display color scheme mode can be changed according to the operating environment, such as daytime or nighttime. Depending on the mode, the window background color, text color, gain, and operation panel brilliance change.

1. Press the  key to show the [Brilliance/ Panel Dimmer] adjustment window. The window automatically closes if there is no key operation for approx. six seconds.
2. Press  or  to select background display mode.

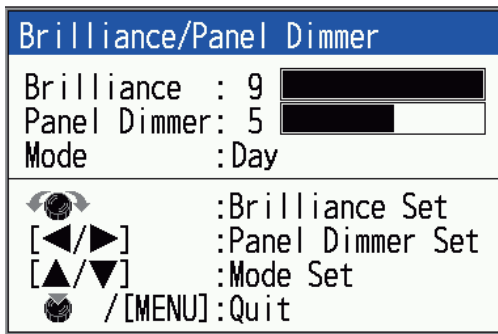

Day mode (background shown as white)

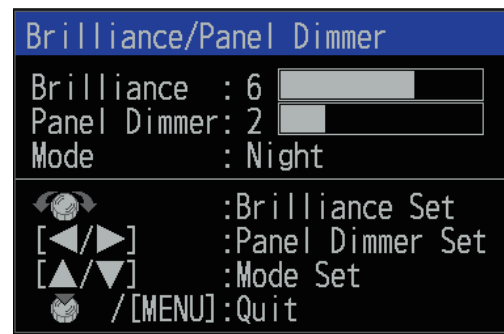

Night mode (background shown as black)

3. Press the **KNOB** or **MENU/ESC** key to close the window.

1.5 Display Mode

The unit has four basic display modes (single frequency, dual-frequency, zoom and navigation). By combining these modes, a variety of screens can be displayed. See subsection 1.5.6 for details on how to combine the displays.

The display mode is selected from the [Mode] window. The factory default setting is set as shown in the table below. The display in the [Mode] window varies depending on the type of transducer connected to the unit and its settings.

Default settings of [Mode] window (for FCV-600)

Transducer Type	[Mode] window	Abbreviation
XDR: CHIRP	Mode1: CHIRP (*) Mode2: CHIRP (*) BL Mode3: BL/ CHIRP (*) Mode4: NAV4/ CHIRP (*) Mode5: NAV2/ CHIRP (*) Mode6: Off Mode7: Off	CHIRP: CHIRP transducer L: Low frequency M: Medium frequency H: High frequency BL: Bottom lock NAV: Navigation (split into 2:2 or 4:4 display)
XDR: CW (L/H)	Mode1: CW (H) Mode2: CW (L) Mode3: CW (L)/ CW (H) Mode4: BL/ CW (H) Mode5: BL/ CW (L) Mode6: NAV4/ CW (H) Mode7: NAV2/ CW (L)	CW: CW transducer H: High frequency L: Low frequency BL: Bottom lock NAV: Navigation (split into 2:2 or 4:4 display)

*: L, M, or H is entered depending on the type of connected transducer.

1. OPERATION

Default settings of [Mode] window (for FCV-800)

Transducer		[Mode] window	Abbreviation
Setting	Type		
When XDR1/XDR2 is set to [On]	XDR1: CHIRP XDR2: CHIRP	Mode1: CHIRP (*) Mode2: CHIRP (L) Mode3: CHIRP (L)/ CHIRP (*) Mode4: BL/ CHIRP (*) Mode5: BL/ CHIRP (L) Mode6: NAV4/ CHIRP (*) Mode7: NAV2/ CHIRP (L)	CHIRP: CHIRP transducer L: Low frequency M: Medium frequency H: High frequency BL: Bottom lock NAV: Navigation (split into 2:2 or 4:4 display)
	XDR1: CW (L/H) XDR2: CHIRP	Mode1: CHIRP (*) Mode2: CW (H) Mode3: CW (L)/ CW (H) Mode4: BL/ CHIRP (*) Mode5: BL/ CW (H) Mode6: NAV4/ CHIRP (*) Mode7: NAV2/ CW (H)	CW: CW transducer CHIRP: CHIRP transducer L: Low frequency M: Medium frequency H: High frequency BL: Bottom lock NAV: Navigation (split into 2:2 or 4:4 display)
When XDR1 is set to [On], XDR2 is set to [Off]	XDR1: CHIRP	Mode1: CHIRP (L) Mode2: CHIRP (L) BL Mode3: BL/ CHIRP (L) Mode4: NAV4/ CHIRP (L) Mode5: NAV2/ CHIRP (L) Mode6: Off Mode7: Off	CHIRP: CHIRP transducer L: Low frequency BL: Bottom lock NAV: Navigation (split into 2:2 or 4:4 display)
	XDR1: CW (L/H)	Mode1: CW (H) Mode2: CW (L) Mode3: CW (L) / CW (H) Mode4: BL / CW (H) Mode5: BL / CW (L) Mode6: NAV4 / CW (H) Mode7: NAV2 / CW (L)	CW: CW transducer L: Low frequency H: High frequency BL: Bottom lock NAV: Navigation (split into 2:2 or 4:4 display)
When XDR1 is set to [Off], XDR2 is set to [On]	XDR2: CHIRP	Mode1: CHIRP (*) Mode2: CHIRP (*) BL Mode3: BL/ CHIRP (*) Mode4: NAV4/ CHIRP (*) Mode5: NAV2/ CHIRP (*) Mode6: Off Mode7: Off	CHIRP: CHIRP transducer M: Medium frequency H: High frequency BL: Bottom lock NAV: Navigation (split into 2:2 or 4:4 display)

*: M or H is entered depending on the type of connected transducer.

1.5.1 How to change the display mode

1. Press the **MODE** key to open the [Mode] setting window. The window automatically closes if there is no key operation for approx. six seconds.

MODE
Mode1: CHIRP(H)
Mode2: CHIRP(L)
Mode3: CHIRP(L)/CHIRP(H)
Mode4: BL/CHIRP(H)
Mode5: BL/CHIRP(L)
Mode6: NAV4/CHIRP(H)
Mode7: NAV2/CHIRP(L)

2. Press the **MODE** key again to select the display mode desired. The meanings of the mode names at the top of the display are shown in the table below.

Mode Name	Meaning	Mode Name	Meaning
CHIRP LF	CHIRP transducer, Low frequency	CHIRP BZ LF	CHIRP transducer, Bottom zoom, Low frequency
CHIRP MF	CHIRP transducer, Medium frequency	CHIRP BZ MF	CHIRP transducer, Bottom zoom, Medium frequency
CHIRP HF	CHIRP transducer, High frequency	CHIRP BZ HF	CHIRP transducer, Bottom zoom, High frequency
CW LF	CW transducer, Low frequency	CW BZ LF	CW transducer, Bottom zoom, Low frequency
CW HF	CW transducer, High frequency	CW BZ HF	CW transducer, Bottom zoom, High frequency
CHIRP BL LF	CHIRP transducer, Bottom lock, Low frequency	CHIRP MZ LF	CHIRP transducer, Marker zoom, Low frequency
CHIRP BL MF	CHIRP transducer, Bottom lock, Medium frequency	CHIRP MZ MF	CHIRP transducer, Marker zoom, Medium frequency
CHIRP BL HF	CHIRP transducer, Bottom lock, High frequency	CHIRP MZ HF	CHIRP transducer, Marker zoom, High frequency
CW BL LF	CW transducer, Bottom lock, Low frequency	CW MZ LF	CW transducer, Marker zoom, Low frequency
CW BL HF	CW transducer, Bottom lock, High frequency	CW MZ HF	CW transducer, Marker zoom, High frequency

1

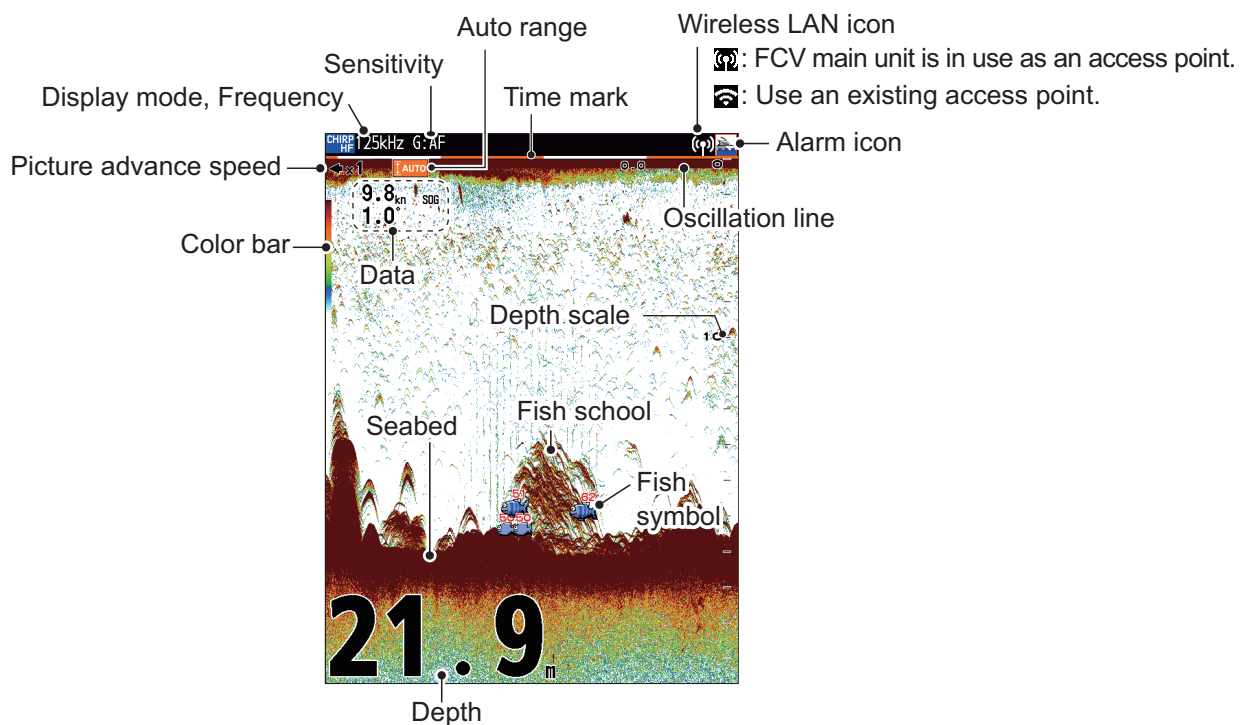

Example of displayed screen

1.5.2 Single frequency display

Low frequency: The sounder uses ultrasound pulse signals to detect bottom conditions. The lower the frequency of the signal, the wider the detection area.

High frequency (Medium frequency): The higher the frequency of the ultrasound pulse signal, the better the resolution. High (or medium) frequency is ideal for detailed observation of schools of fish.

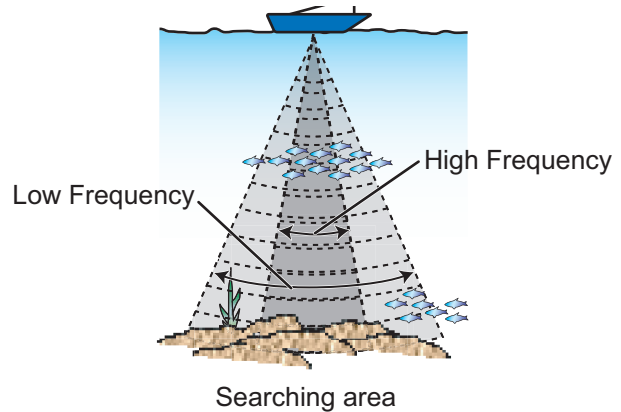

Note: By changing the display mode settings, Bottom Lock display (or Bottom Zoom display) can also be displayed in full screen (see subsection 1.5.6).

1.5.3 Dual frequency display

High and medium frequency images are simultaneously displayed on the right half of the screen and low frequency images are displayed on the left half of the screen. Different frequencies allow for different ranges (beam widths) to be seen and fish species to be reflected, allowing for identification of fish species and knowing if you are getting close to the center of a school of fish.

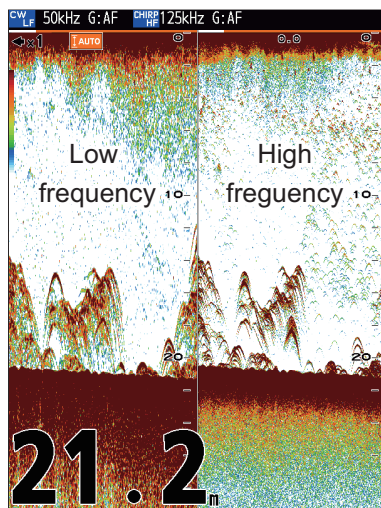

	Beamwidth	Resolution	Detection range	Bottom tail
Low freq.	Wide	Low	Deep	Long
High freq.	Narrow	High	Shallow	Short

1.5.4 Zoom displays

Zoom mode expands the selected area of the single frequency picture. Three modes are available: bottom lock, bottom zoom and marker zoom.

Note 1: To adjust the range of the zoom display, go to the [Range] menu (see section 2.2).

Note 2: To show or hide the zoom marker, go to the [Display] menu.

Bottom lock display

The bottom lock display provides a normal picture on the right half of the screen and a wide layer in contact with the bottom is expanded onto the left half of the screen. This mode is useful for detecting bottom fish.

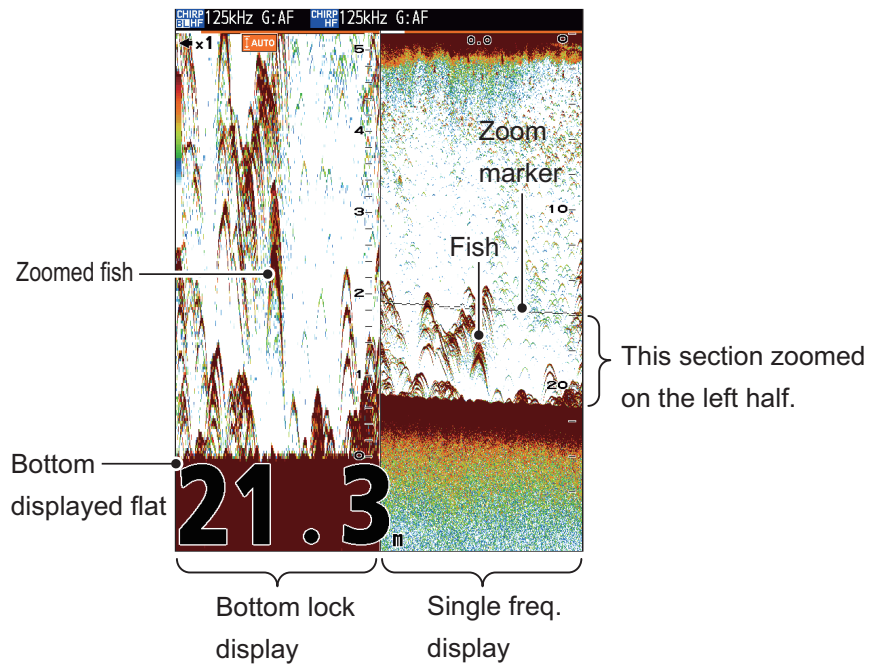

Bottom zoom display

The bottom zoom mode expands bottom and bottom fish on the left half of the screen. This mode is useful for tracking bottom contour. When the bottom depth increases (or decreases), the display automatically shifts to keep the bottom echo at the lower part of the screen.

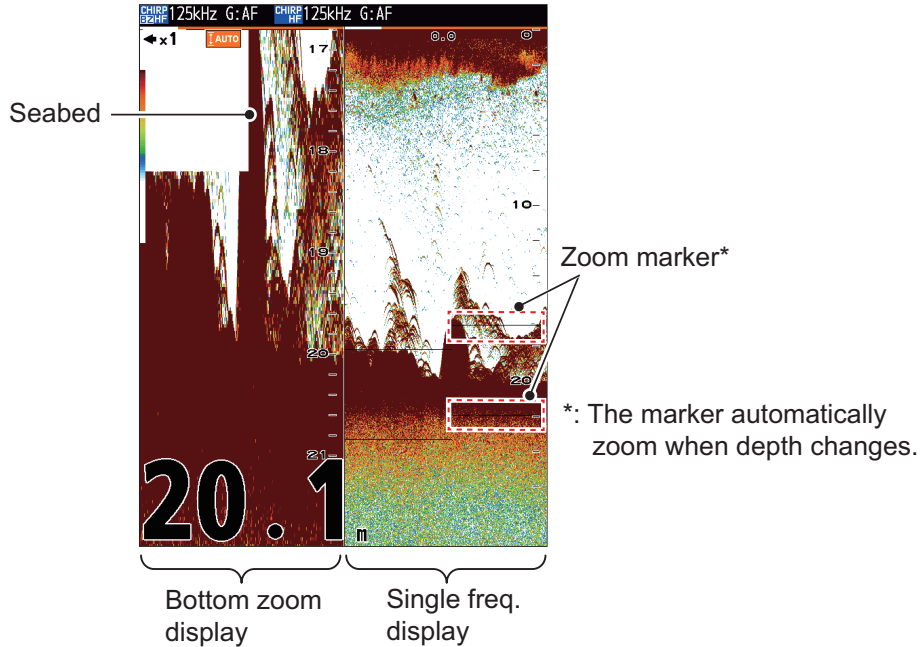

Marker zoom display

The marker zoom mode expands chosen area of the normal picture to full vertical size of the screen on the left half of the screen. You may specify the portion to expand by operating the VRM (Variable Range Marker), which you can shift with ▲ or ▼. The area between the VRM and zoom marker is expanded. This mode is useful for determining the size of fish in the middle water.

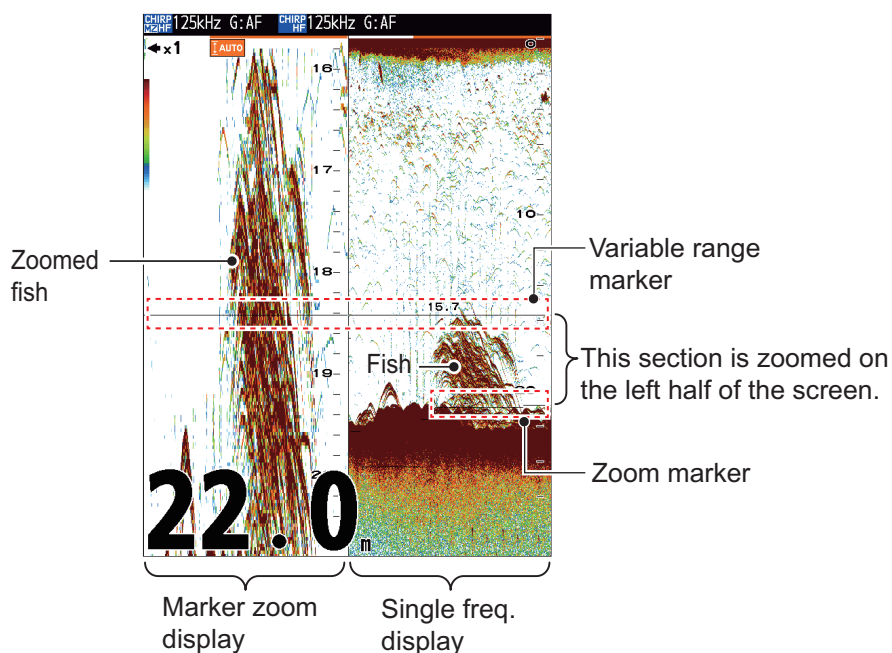

1.5.5 Nav data display

The right half of the screen displays the "single" image, and the left half displays the navigation screen (2 to 4 data display). The default settings are as follows.

- Two-data display: Depth, wind speed/direction
- Three-data display: Wind speed/direction, Depth, Speed (STW)
- Four-data display: Speed (STW), Depth, Water temperature, Latitude/Longitude

Various data are required to display information other than depth.

See section 1.24 to change the information displayed on the screen and the next section to change the way the screen is divided.

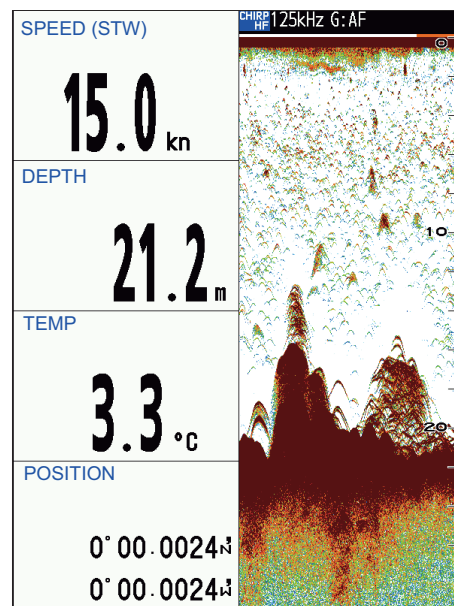

Example of four-data display

1.5.6 Edit display mode

Seven display modes can be registered for this equipment. The display mode set here will appear as a choice in the [MODE] window. Carry out the following to edit display mode.

1. Press the **MENU/ESC** key to open the menu.
2. Select [Display], then press the **KNOB**.
3. Select [Disp Mode Config], then press the **KNOB**.

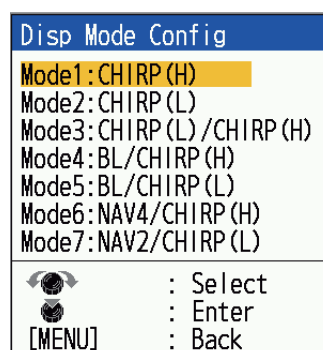

1. OPERATION

4. Select the display mode to edit, then press the **KNOB**.
[Disp Setting] window will be shown.

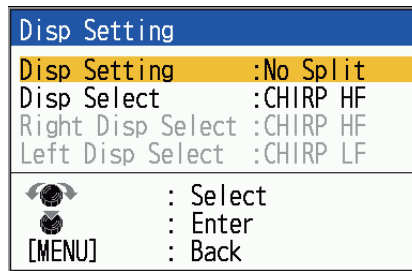

5. Select [Disp Setting], then press the **KNOB**.
6. Select one of the following, then press the **KNOB**.
 - [No Split]: Displayed as single data window. Go to step 7.
 - [Split]: Displayed as multiple data window (Dual- freq., Zoom, Navigation). Go to step 9.
7. Select [Disp Select], then press the **KNOB**.
The available selections vary depending on the type of transducer connected to the unit.

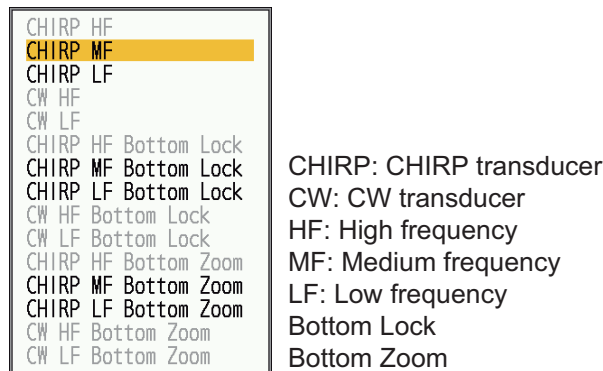

8. Select the desired display mode, then press the **KNOB**.
Continue to step 13.
9. Select [Right Disp Select], then press the **KNOB**.
The items that can be selected vary depending on the type of transducer connected to the unit.

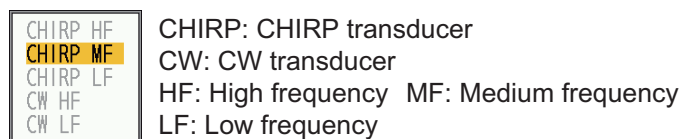

10. Select the display to be shown on right side of the window, then press the **KNOB**.

11. Select [Left Disp Select], then press the **KNOB**.

CHIRP HF	CHIRP: CHIRP transducer
CHIRP MF	CW: CW transducer
CHIRP LF	HF: High frequency
CW HF	MF: Medium frequency
CW LF	LF: Low frequency
Bottom Lock	NAV2: 2-data navigation display
Bottom Zoom	NAV3: 3-data navigation display
Marker Zoom	NAV4: 4-data navigation display
NAV2	
NAV3	
NAV4	

12. Select the display to be shown on left side of the window, then press the **KNOB**.
13. Press the **MENU/ESC** key twice to close the window.

How to turn off unused display mode

The display modes from Mode 2 to Mode 7 can be turned off. Once set to off, the display modes are skipped when the [Mode] key is pressed. For example, if mode 3 is set to off, pressing the **MODE** key will switch between mode1→mode2→mode4→mode5→...etc.

1. Press the **MENU/ESC** key to open the menu.
2. Select [Display], then press the **KNOB**.
3. Select [Disp Mode Config], then press the **KNOB**.
4. Select the mode to turn off (except mode1), then press the **KNOB**.
5. Select [Disp Setting], then press the **KNOB**.
6. Select [Off], then press the **KNOB**.
7. Press the **MENU/ESC** key twice to close the window.

1.6 How to Select a Range

The basic range may be selected in the [Auto] or [Manual] mode.

Note: The **RANGE** key is inoperative when the bottom discrimination feature is active.

1. Press the **RANGE** key to open the [Range] setting window.

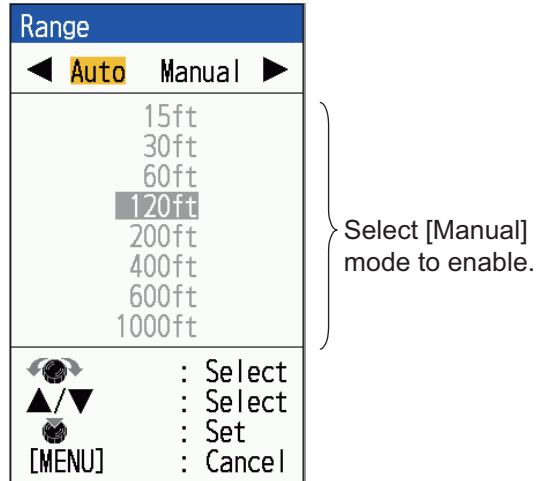

2. Use ◀ or ▶ to select [Auto] or [Manual].
 - [Auto]: The range changes automatically to display the bottom echo on the screen always. (The shift function is inoperative in the auto mode.) [] is shown at the top left corner on the screen. Note that the deepest detection range of Auto Range is the largest setting of [Range 1] to [Range 8] of Manual Range. In case the sea bottom is deeper than the largest setting of Auto Range, set the setting of [Range 1] to [Range 8] deeper than the sea bottom.
 - [Manual]: The range may be selected from the eight ranges listed below. If you selected [Auto], go to step 4. For [Manual], continue to the next step.
3. For [Manual], use the **RANGE** key (or ▲▼) to select the range. Also rotating **KNOB** can be used to select the range.

Unit	Basic Range							
	1	2	3	4	5	6	7	8
m	5	10	20	40	80	150	200	300
ft	15	30	60	120	200	400	600	1000
fm	3	5	10	20	40	80	100	150
HR*	4	8	15	30	50	100	150	200
pb	3	5	10	20	50	100	150	200

*: Japanese unit of depth measurement (hiro)

4. Press the **KNOB**.

Note: The value for range can be adjusted (see page 2-1).

1.7 How to Adjust the Gain

The gain may be adjusted automatically ([Fishing] or [Cruising]) or manually.

Automatic adjustment

In automatic adjustment, the range is automatically selected to display the bottom echo in reddish brown. The automatic gain setting can be fine tuned with the offset gain feature. Clutter and TVG are also adjusted automatically when automatic gain is active.

1. Press the **GAIN** key to open the [Auto Gain] setting window.

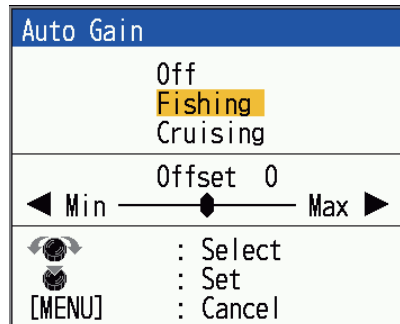

2. Rotate the **KNOB** to select [Fishing] or [Cruising].

You can also press the **GAIN** key to select the desired mode.

[Fishing]: This mode clearly displays weaker echoes and is useful for searching for schools of fish. "G:AF" is shown at the top left corner on the screen.

[Cruising]: This mode clearly displays stronger echoes (for example, bottom) and suppresses weak echoes. Use this mode for general cruising. "G:AC" is shown at the top left corner on the screen.

Note: If the header is not displayed, set [Header Info] to [On] in the [Display] menu (see page 1-49).

You can apply an offset to the gain, at step 3. To apply no offset, go to step 4.

3. Press ◀ or ▶ (setting range: -5 to +5) to apply an offset. Press ◀ to decrease the offset; ▶ to raise the offset.
4. Press the **KNOB**. The new gain setting is also applied to past echoes.

Manual adjustment

For manual gain adjustment, adjust the gain according to signal strength. For dual frequency display, gain can be adjusted by frequency.

	CAUTION
Adjust the gain correctly.	
If the value of the gain setting is too small, weak signals will be suppressed and no indication appears. If the value is too large, noise will fill the screen and the indication will be difficult to distinguish. It is dangerous to use the depth display as a reference when operating the vessel without a clear indication of the seabed.	

1. OPERATION

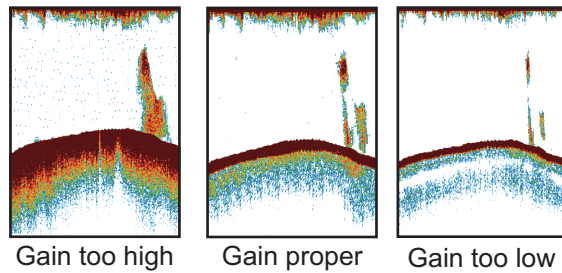

1. Press the **GAIN** key to open the [Auto Gain] setting window.
2. Rotate the **KNOB** to select [Off]. The gain value (example: [G: 50]) appears on the top of the display.
3. Press the **KNOB**.
4. When the dual frequency window is displayed, press the **KNOB** to specify the display to be adjusted.
Each press of the **KNOB** switches the highlighted display to indicate the selected screen.
5. Rotate the **KNOB** to adjust the gain (0-100).
When adjusting, the gain value will be highlighted. When the gain is changed, it is also reflected on the past image displayed on the screen.

1.8 How to Measure Depth

The VRM (Variable Range Marker) functions to measure the depth to schools of fish, etc. This function is inoperative when a NAV data display is active.

Note: This operation cannot be used when Nav data window is displayed.

1. On the sonar screen, Use ▲ or ▼ to place the VRM on the object to measure depth.
2. Read the VRM depth, which appears above the VRM.

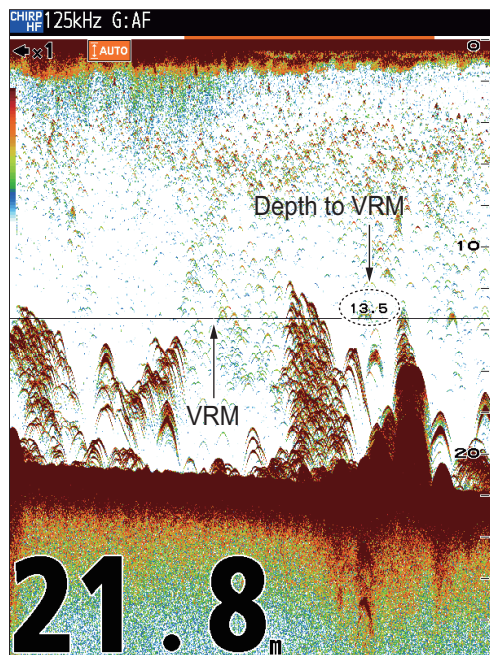

1.9 Menu Operating Procedure

Your fish finder has five main menus: [Sounder], [Display], [Alarm], [Data], and [System]. Below is the basic menu operating procedure.

1. Press the **MENU/ESC** key to open the menu.

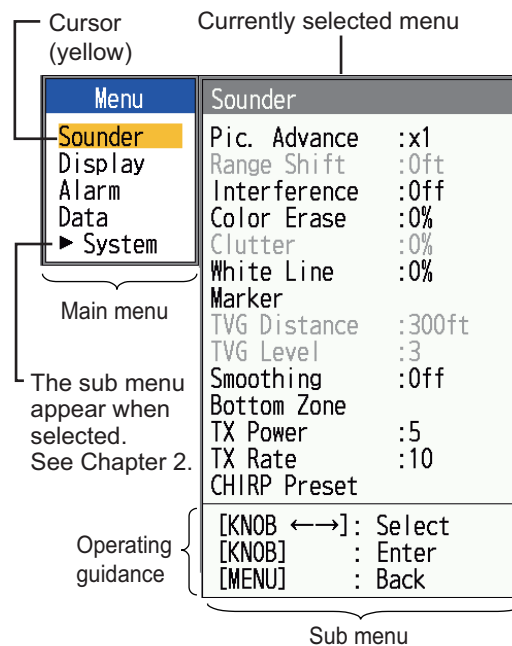

2. Rotate the **KNOB** to select the main menu desired. The cursor (yellow) highlights current selection. The items in the sub menu change with the menu selected.
3. Press the **KNOB**. The cursor (yellow) shifts to the sub menu and the current selection on the main menu window (left) is highlighted in gray.
4. Rotate the **KNOB** to select the menu item desired, then press the **KNOB**. A setting box or window appears depending on menu item. The example below shows the setting options and setting window for [Depth Size].

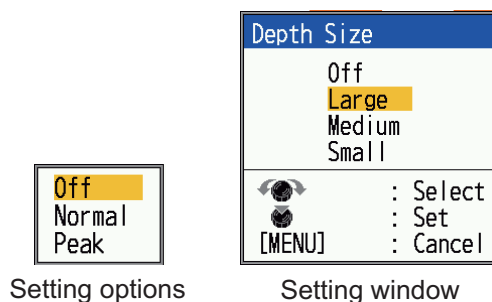

5. Rotate the **KNOB** to select an option or change a value.
6. Press the **KNOB** to save the setting. The setting box or window disappears. To escape without changing a setting, press the **MENU/ESC** key instead of the **KNOB**.
7. To select another menu, press the **MENU/ESC** key. The cursor (yellow) moves to the main menu.
8. Press the **MENU/ESC** key to close the menu.

1. OPERATION

Typing mode

When you select an item that requires text input, the following input window will appear. You can input alphabetic characters (lower and upper letters), numbers and symbols.

1. Select typing mode (abc, ABC, ?123, ~[<) and press the **KNOB**.

Name												
ALARM1												
abc			ABC			?123			~[<			
q	w	e	r	t	y	u	i	o	p			
a	s	d	f	g	h	j	k	l	/			
z	x	c	v	b	n	m	!	?	,			
Space			Del		←	→	A/*	Enter				

Typing mode: Alphabet (lowercase letters)

Name												
ALARM1												
abc			ABC			?123			~[<			
Q	W	E	R	T	Y	U	I	O	P			
A	S	D	F	G	H	J	K	L				
Z	X	C	V	B	N	M	!	?				
Space			Del		←	→	A/*	Enter				

Typing mode: Alphabet (uppercase letters)

Name												
ALARM1												
abc			ABC			?123			~[<			
1	2	3	4	5	6	7	8	9	0			
@	#	\$	%	&	-	+	()	=			
\	*	'	:	;	<	>						
Space			Del		←	→	A/*	Enter				

Typing mode: Numerical

Name												
ALARM1												
abc			ABC			?123			~[<			
~	[]	^	_	{	}						
Space			Del		←	→	A/*	Enter				

Typing mode: Symbol

2. Select character and press the **KNOB**.
3. Repeat step 1 to step 2 and input all the characters.
To erase a character, select [←] or [→], press the **KNOB** and move the cursor to the character you want to erase. Select [Del] and press the **KNOB**.
4. Select [Enter] and press the **KNOB**.

1.10 How to Shift the Range

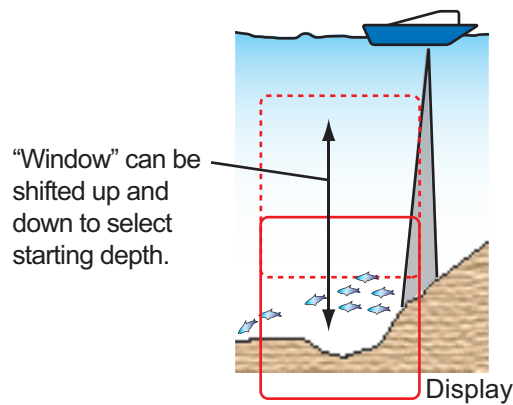

The basic range and range shift together give you the means to select the depth you can see on the screen. The basic range can be thought of as providing a “window” into the water column and range shifting as moving the “window” to the desired depth.







Note: This function is inoperative when [] (auto range mode indication) is displayed.

The basic range can be shifted up or down in the [Manual] mode as follows:

1. Press the **MENU/ESC** key to open the menu.
2. Open the menu, select the [Sounder] menu, then press the **KNOB**.

Menu	Sounder
Sounder	Pic. Advance :x1
Display	Range Shift :0ft
Alarm	Interference :0ff
Data	Color Erase :0%
► System	Clutter :0%
	Echo Expand :0ff
	White Line :0%
	Marker
	TVG Distance :300ft
	TVG Level :3
	Smoothing :0ff
	Bottom Zone
	TX Power :5
	TX Rate :10
	CHIRP Preset
	 : Select
	 : Enter
	[MENU] : Back

3. Select [Range Shift], then press the **KNOB**.

Range Shift	
  0ft 	
(0~4000ft)	
	: Select
	: Set
[MENU]	: Cancel

4. Set the amount of shift desired, then press the **KNOB**. The step for the amount of shift depends on setting range on the [Range] sub menu in the [System] menu.
5. Press the **MENU/ESC** key twice to close the window.

Note: Echoes may be lost if the amount of shift is greater than actual depth.

1.11 Picture Advance Speed

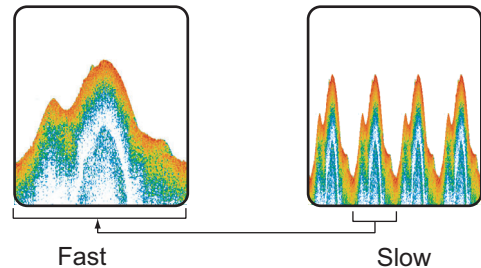

The picture advance speed determines how quickly the vertical scan lines run across the screen. When selecting a picture advance speed, keep in mind that a fast advance speed will expand the size of a school of fish horizontally on the screen and a slow advance speed will contract the school. Use a fast advance speed to observe a rugged bottom, and use a slow advance speed to monitor a smooth bottom.

 <h3 style="margin: 0;">CAUTION</h3>
<p>The picture is not refreshed when picture advancement is stopped.</p> <p>Cruising in this condition may result in grounding in shallow waters.</p>



Note: When ACCU-FISH™ or Bottom Discrimination function is in use, the image feed speed may slow down.

1. Press the **MENU/ESC** key to open the menu.
2. Select [Sounder], then press the **KNOB**.
3. Select [Pic. Advance], then press the **KNOB**.

Pic. Advance	
x8	Fast ↑ ↓ Slow
x4	
x2	
x1	
1/2	
1/4	
1/8	
1/16	
Stop	
 : Select  : Set [MENU] : Cancel	

4. Select the desired picture advance speed, then press the **KNOB**. [1/16] is the slowest speed and [x8] is the fastest available speed. Current picture advance speed is displayed at the top of the screen. [1/16] means one scan line is produced every 16 transmissions and [x8] means eight scan lines are produced in one transmission. [Stop] stops the picture advancement. The [Stop] is also useful for taking screenshots.
5. Press the **MENU/ESC** key twice to close the window.

1.12 How to Reduce Interference

Interference from other acoustic equipment operating nearby or other electronic equipment on your boat may show itself on the display as shown in the figure below. Follow the procedure below to reduce interference.

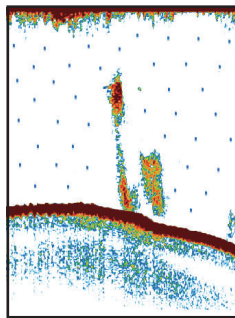

Interference from
other sounder

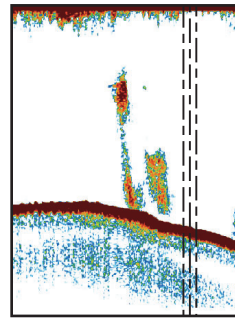

Interference from
electrical equipment

1. Press the **MENU/ESC** key to open the menu.
2. Select [Sounder], then press the **KNOB**.
3. Select [Interference], then press the **KNOB**.

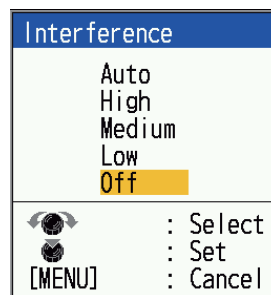

4. Select the degree of interference reduction desired, then press the **KNOB**.
 [Auto]: Interference is suppressed automatically.
 [High], [Medium], [Low]: [High] provides the greatest degree of interference reduction and [Low] the smallest.
 [Off]: Turn off the interference rejector.
Note: Turn off the interference rejector when no interference exists, so as not to miss weak echoes from small targets.
5. Press the **MENU/ESC** key twice to close the window.

1.13 How to Reduce Low Level Noise

Low intensity "speckles," caused by sediments in the water or noise, may appear over most of screen. These speckles can be suppressed by adjusting the [Clutter].

Note: [Clutter] cannot be adjusted when [Fishing] or [Cruising] is selected on the [Auto Gain] setting window.

1. Press the **MENU/ESC** key to open the menu.
2. Select [Sounder], then press the **KNOB**.
3. Select [Clutter], then press the **KNOB**.

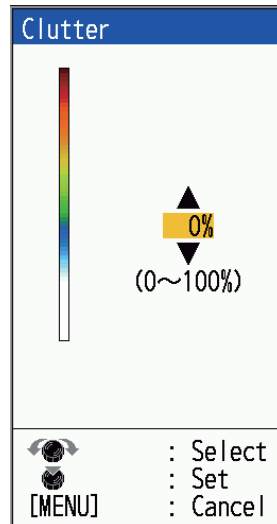
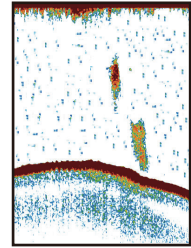

4. Select the degree of clutter reduction desired, then press the **KNOB**. The setting range is 0% to 100% in intervals of ten. The larger the setting value, the greater the degree of reduction.
5. Press the **MENU/ESC** key twice to close the window.

1.14 How to Erase Weak Echoes

Sediment in the water or reflections from plankton may be painted on the display in low intensity tones. These weak echoes may be erased by using the [Color Erase] feature. This feature erases weaker echoes sequentially to show only strong echoes and clear the picture.

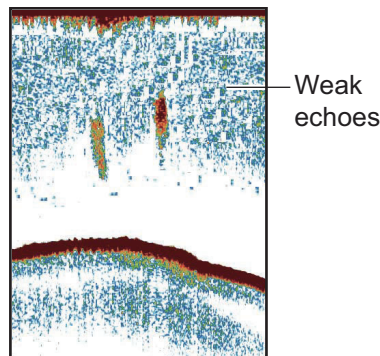

1. Press the **MENU/ESC** key to open the menu.
2. Select [Sounder], then press the **KNOB**.

3. Select [Color Erase], then press the **KNOB**.

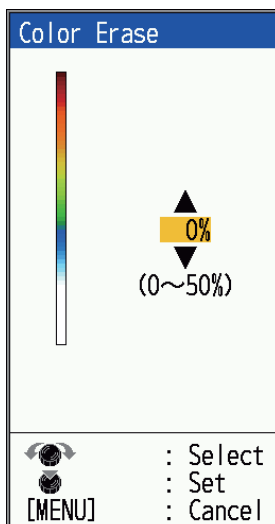

4. Select the color to erase, then press the **KNOB**. The setting range is 0 to 50% in intervals of one per cent. The larger the setting value, the greater the number of colors that are erased.
5. Press the **MENU/ESC** key twice to close the window.

1.15 A-scope Display

The A-scope display shows echoes at each transmission with amplitudes and tone proportional to their intensities, on the right 1/3 of the screen. The display shows strong echoes with strong amplitude; weak echoes in weak amplitude. Thus the A-scope display is useful for estimating the kind of school of fish and bottom composition.

Note: The A-scope display is only available with the high frequency display in dual frequency operation.

1. Press the **MENU/ESC** key to open the menu.
2. Select [Display], then press the **KNOB**.

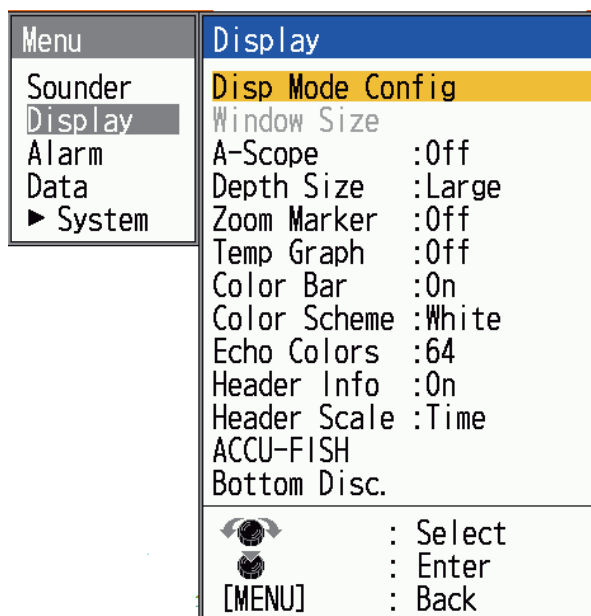

1. OPERATION

3. Select [A-Scope], then press the **KNOB**.

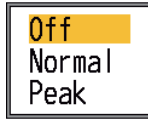

4. Select the A-scope presentation type desired, then press the **KNOB**.
[Off]: Turn off the A-scope display.
[Normal]: Display shows echoes at each transmission with amplitudes and tone proportional to their intensities.
[Peak]: "Normal" A-scope display plus peak-hold amplitude picture for last five seconds in dots.
5. Press the **MENU/ESC** key twice to close the window.

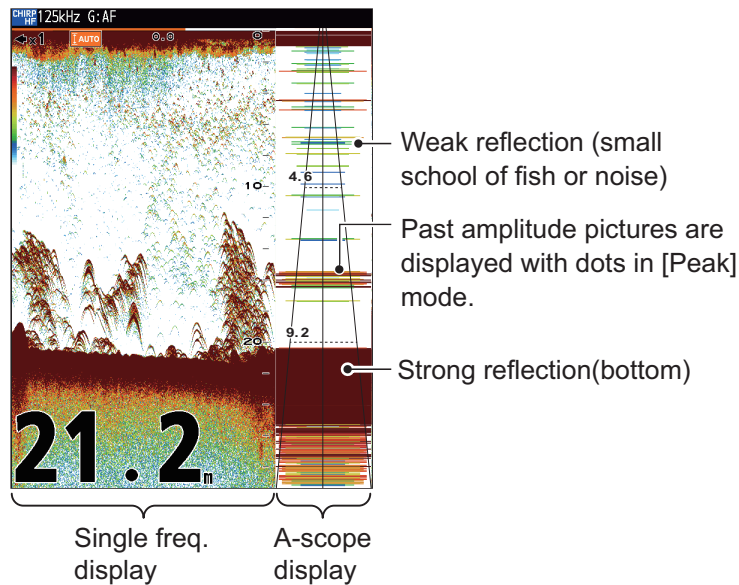

Note: To turn off the A-scope display, select [Off] in step 4.

Directional angle display

With the transducer, directional angle range line, directional angle diameter and directional angle diameter line appear on the A-scope display. The directional angle display provides an at-a-glance view of the available detection range. In the example below an echo from a school of fish is at the depth of 10 m. and within 4.6 m diameter of the center of the transducer beam.

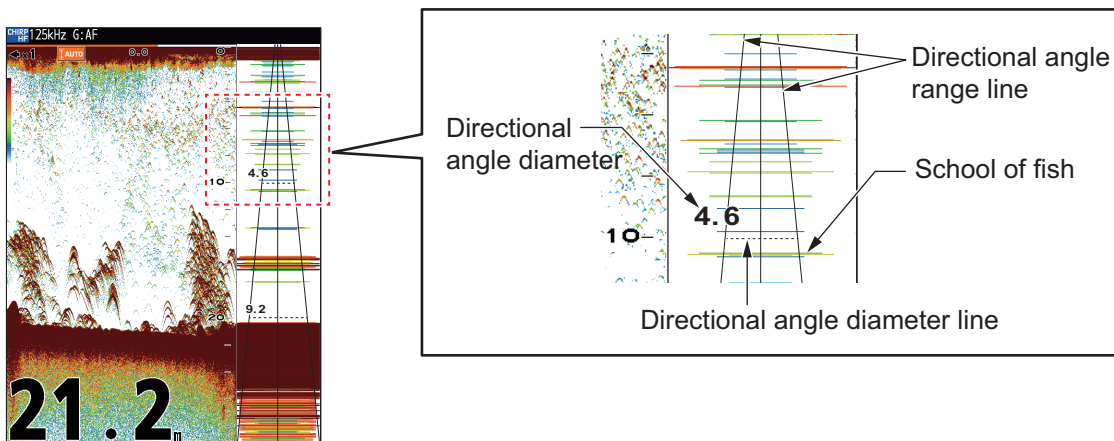

Note: The directional angle range lines represent the transducer beam width. They are not an indication of echo strength.

1.16 Displaying history

You can scroll the screen to see the past fish finder displays (3 screens). This function is called “scroll back mode”. This is a convenient function when you want to see the previous fish finder displays.

Note 1: This operation cannot be used when Nav data window is displayed.

Note 2: The display freezes during scroll-back mode. Do not use during normal navigation.

1. To switch into scroll-back mode, press ◀. The icon below appears on the top of the screen.



2. Press ◀ or ▶ to check the display. Pressing ◀ scrolls the display toward the past. Conversely, press ▶ to scroll display to the current time. Pressing the button scrolls the image toward the current time.
3. Press **MENU/ESC** key to deactivate the scroll-back mode.

1.17 Fish Information (ACCU-FISH™)

The ACCU-FISH™ feature measures the length of individual fish and tags the fish with a fish symbol whose size is proportional to the length of the fish. The length or depth of the fish can be indicated digitally. Connection to a transducer* that supports ACCU-FISH™ is required.

*: See page AP-5 “Transducer List” for further information.

Considerations for ACCU-FISH™

- The size values for individual fish are for reference purposes only and do not indicate the exact size of the fish.
- Echo intensity depends on fish species. When the fish length differs between the indicated length and the actual length, you can compensate the difference (see page 2-7).
- High and low frequencies are alternately transmitted when ACCU-FISH™ is active, regardless of mode selection.
- A fish whose depth is shallower than 2 m* or greater than 100 m cannot be measured.
 - *: Even when the zero line rejection function is used, single fish are not detected even in areas within the adjustment range (see page 2-7).
- This feature cannot be used with the inside-hull transducer since a fish may not be detected depending on the transducer's frequency. Even if a fish is detected, the fish length indicated may be smaller than actual length.
- In a school of fish echoes overlap one another, so the margin of error will be greater.
- The bottom echo must be present to show the fish mark.
- The TX pulse length changes according to ACCU-FISH™ On/Off state. This causes a difference in both sensitivity and the echoes viewed.

1.17.1 How to activate ACCU-FISH™

Note: This operation cannot be performed if ACCU-FISH™ compatible transducer is not set up.

1. Press the **MENU/ESC** key to open the menu.
2. Select [Display], then press the **KNOB**.
3. Select [ACCU-FISH], then press the **KNOB** to show the [ACCU-FISH] menu.
4. Select [ACCU-FISH], then press the **KNOB**.
5. Select [On] to enable ACCU-FISH™.
6. Press the **MENU/ESC** key twice to close the window.

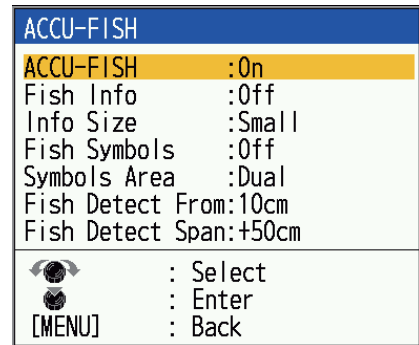

Note: To disable ACCU-FISH™ function, select [Off] on step 5.

1.17.2 Fish symbols

There are four types of shapes to choose for fish symbol.

1. Press the **MENU/ESC** key to open the menu.
2. Select [Display], then press the **KNOB**.
3. Select [ACCU-FISH], then press the **KNOB** to show the [ACCU-FISH] menu.
4. Select [Fish Symbols], then press the **KNOB**.
5. Select desired symbol, then press the **KNOB**. The size of the symbol is scaled according to the estimated length of the fish. To hide the fish symbol, select [Off] at step 4, then press the **KNOB**.

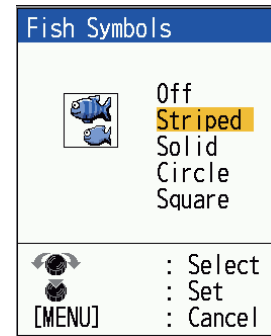

	Striped	Solid	Circle	Square
Large fish symbol (more than 50 cm, or more than 20 inches)				
Small fish symbol (10 to 49 cm, or 4 to 19 inches)				

6. Press the **MENU/ESC** key twice to close the window.

Note: You can select which frequency display to show the fish symbols and fish information, with [Symbols Area] on the [ACCU-FISH] menu.

- [Dual]: Symbols and info shown on both HF and LF displays.
- [HF]: Symbols and info shown on HF display.
- [LF]: Symbols and info shown on LF display.

1.17.3 Fish info

1. Press the **MENU/ESC** key to open the menu.
2. Select [Display], then press the **KNOB**.
3. Select [ACCU-FISH], then press the **KNOB** to show the [ACCU-FISH] menu.

4. Select [Fish Info], then press the **KNOB**.
5. Select [Fish Size] or [Depth] as appropriate, then press the **KNOB**.

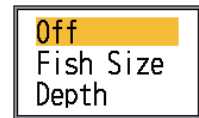
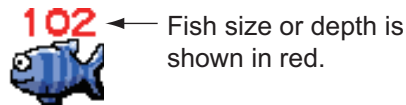

Note 1: You can show the fish info figure alone (without fish symbol) by turning off [Fish Symbols] on the [Display] menu.

Note 2: You can show the fish info in small or large characters, with [Info Size] on the [ACCU-FISH] menu.

1.17.4 Restrict the fish symbol display

When multiple fish symbols are displayed, the screen becomes cumbersome. You can limit the display of fish symbols by adjusting the required single fish size.

1. Press the **MENU/ESC** key to open the menu.
2. Select [Display], then press the **KNOB**.
3. Select [ACCU-FISH], then press the **KNOB**.
4. Select [Fish Detect From], then press the **KNOB**.
5. Set the size value, then press the **KNOB**.
For example, if you set [Fish Detect From] to 10 cm and [Fish Detect Span] to +50 cm, fish symbols other than those between 10 and 60 cm will not be displayed on the screen.
6. Select [Fish Detect Span], then press the **KNOB**.
7. Set the span value, then press the **KNOB**.
8. Press the **MENU/ESC** key twice to close the window.

1.18 Bottom Discrimination Display

The bottom discrimination display analyzes the bottom echo to categorize bottom hardness in one of four types (rocks, gravel, sand, mud) and shows the results in a colorful graphic display. A transducer or triducer* that supports the bottom discrimination display is required.

*: See page AP-5 "Transducer List" for further information.

There are two bottom discrimination displays: graphic and probability.

1. OPERATION

- **Graphic display:** The most probable material on the bottom (mud, sand, gravel, rock) is indicated graphically.

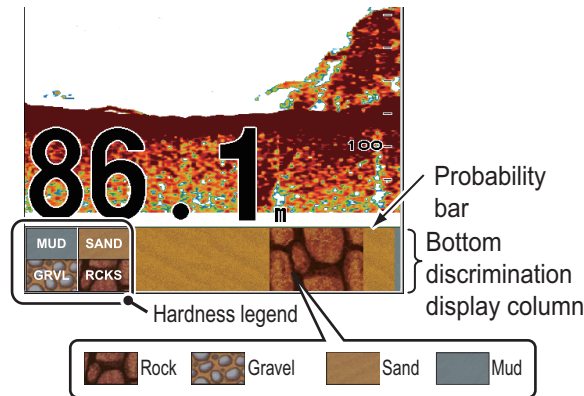

Probability bar:
Degree of trust for bottom discrimination display
(Green, Normal; Yellow, Caution;
Background color, Abnormal)

- **Probability display:** The most probable bottom material is indicated in proportion.

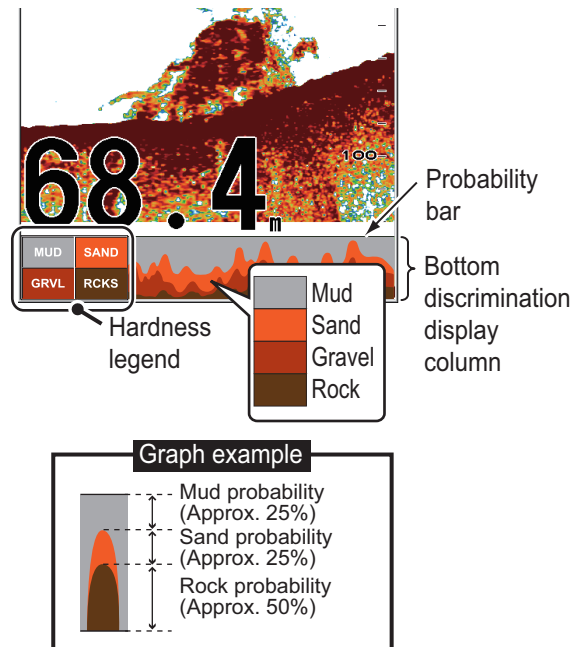

About the bottom discrimination display

- The bottom discrimination display provides an estimate of bottom composition. Actual composition may be different.
- The high and low frequencies are alternately transmitted, regardless of current display selection. The TX interval is slower when this feature is active.
- Operating environment:
 - Depth: 16 to 328 ft (5m to 100m)
 - Speed: 10 knots or less
- This feature uses the range from the boat's draft; therefore, enter the ship's draft. See page 2-7.
- Be sure that the transducer is mounted straight. Otherwise the bottom discrimination display may not function accurately in case of high waves.
- If there are large fish or schools of fish near the seabed directly below the transducer beam, the discrimination results may not match with the actual result.

How to activate the bottom discrimination display

Note 1: Auto range () is automatically turned on when the bottom discrimination display is activated.

Note 2: This operation cannot be performed if a bottom discrimination compatible transducer is not set up.

1. Press the **MENU/ESC** key to open the menu.
2. Select [Display], then press the **KNOB**.
3. Select [Bottom Disc.], then press the **KNOB**.
4. Select [Bottom Disc.], then press the **KNOB**.
5. Select [Graphic] or [Probability], then press the **KNOB**.
6. Select [Legend], then press the **KNOB**.
7. Select [Off] or [On], then press the **KNOB**.
8. Press the **MENU/ESC** key twice to close the window.

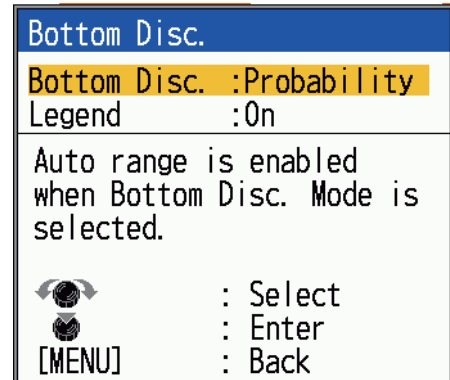

Note: To turn off the bottom discrimination display, select [Off] at step 5, then press the **KNOB**.

1.19 RezBoost™

With a RezBoost™ capable transducer*, echo resolution can be improved. In the example below, it is difficult to distinguish fish from the bottom. With [Enhanced] RezBoost™, fish near the bottom are clearly seen.

*: See page AP-5 "Transducer List" for further information.

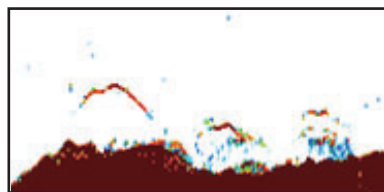

Enhanced mode

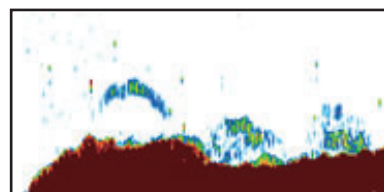

Standard mode

Note 1: This function is not available when a CW transducer and a CHIRP transducer are connected at the same time (only for FCV-800).

Note 2: This operation cannot be performed if a RezBoost™ compatible transducer is not set up.

1. Press the **MENU/ESC** key to open the menu.
2. Select [Sounder], then press the **KNOB**.
3. Select [RezBoost], then press the **KNOB**.
4. Select [On], then press the **KNOB**.
5. Press the **MENU/ESC** key twice to close the window.

Note: To turn off the RezBoost™ function, select [Off] in step 4.

1.20 TVG Settings

Two schools of fish of the same size are displayed in different colors between deep water and in shallow water because of the feature of the ultrasound waves. TVG compensates for propagation attenuation of the ultrasound waves. It does this by equalizing echo presentation so that the schools of fish of the same size appear in the same color (echo strength) in both shallow and deep waters. The gain is adjusted automatically depending on the depth. The gain is low at short distance and increases over distance. In the following example, the TVG distance is set to 100 m and the TVG level is adjusted. Unnecessary echoes at short distances are erased and the display in waters deeper than 100 m remains unchanged.

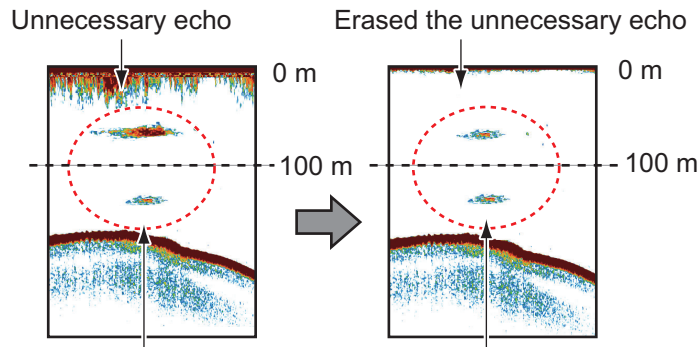

Fish schools of the same size are displayed in different sizes and colors depending on depth.

Fish schools of the same size are displayed in the same size and color

Note: This function is disabled when [Auto Gain] is set to [Fishing] or [Cruising].

1. Press the **MENU/ESC** key to open the menu.
2. Select [Sounder], then press the **KNOB**.
3. Select [TVG Distance], then press the **KNOB**.
4. Set the desired distance for TVG, then press the **KNOB**.
5. Select [TVG Level], then press the **KNOB**.
6. Set the desired level for TVG, then press the **KNOB**.
The higher the value, the lower the sensitivity at close range.
7. Press the **MENU/ESC** key twice to close the window.

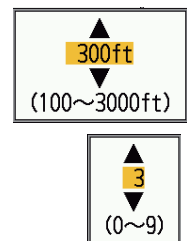

1.21 Alarms

This fish finder has six fish alarms and two navigation alarms. When the conditions of an alarm are met, the audio alarm sounds and the alarm icon (flashing) appears at the top right corner on the display. The audio alarm may be silenced by pressing any key. The alarm icon remains on the screen until the cause of the alarm is removed or the offending alarm is disabled.



Alarm icon*
(flashing)

- * Appears when alarm condition is met.
- : Fish alarm
 - : Speed alarm
 - : Arrival alarm

Description of alarms

● Fish alarms

The **ACCU-FISH™ alarm** alerts you when a fish of the specified length is in the alarm zone. Available when the ACCU-FISH™ feature is active.

The **fish school alarm** alerts you to a school of fish in the set alarm zone.

The **bottom fish alarm** is given when a fish is within the specified distance from the bottom. Available when the bottom lock display is active.

The **water temperature alarm*** alerts you when the water temperature is within (inside alarm) the alarm range set or under/over (outside alarm) the range set.

The **bottom type alarm** alerts you when the bottom type (rock, sand, mud, gravel) matches the bottom type selected. Available when the bottom discrimination display is active.

The **bottom alarm** alerts you when the bottom echo (displayed in red or reddish brown) is within the alarm range set.

● Navigation alarms

The **speed alarm*** alerts you when your boat's speed is within (inside alarm) or under/over (outside alarm) the preset speed.

There are two types of **arrival alarms***: [Inside] and [Outside]. The [Inside] alarm alerts you when you are within the specified range from a waypoint. The [Outside] alarm alerts when your boat travels a specific distance from the location at the activation of the alarm.

* Requires GPS navigator or applicable sensor.

How to activate a fish alarm

Multiple fish alarms (ALARM1 - ALARM5, default names) can be activated. In this case, the audio and visual alarms are released when all alarm conditions are met. For example, the [Bottom Type] alarm is set for [Rock] and the [Bottom] alarm is set for 10-20 feet. Then, if the system judges the bottom to be rock and the depth to the bottom is 10-20 feet, the audio and visual alarms are released. The alarms are not released if only one condition is met.

1. Press the **MENU/ESC** key to open the menu.
2. Select [Alarm], then press the **KNOB**.

Menu	Alarm
Sounder	Fish Alarm
Display	ALARM1 :Off
Alarm	ALARM2 :Off
Data	ALARM3 :Off
► System	ALARM4 :Off
	ALARM5 :Off
	Navigation Alarm
	Speed :Off
	Arrival :Off
	⬅ : Select
	⬇ : Enter
	[MENU] : Back

1. OPERATION

3. Select an alarm among [ALARM1] - [ALARM5] (default alarm names), then press the **KNOB**.
4. Select [Setting], then press the **KNOB**. If you want to change the name of an alarm, go to step 5. Otherwise go to step 7.

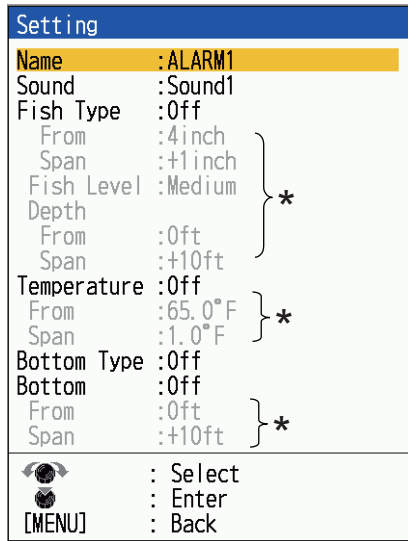

* Operable when corresponding alarm is activated.

5. To change the name of the alarm, select [Name], then press the **KNOB**.
6. Enter the name of the alarm. (Max. of eight characters)
See page 1-16.
7. Select [Sound], then press the **KNOB**.
8. Select the desired alarm sound (sound1 to sound4), then press the **KNOB**.
9. Select [Fish Type], [Temperature], [Bottom Type] or [Bottom] as applicable, then press the **KNOB**.
10. Do one of the following according to the item selected at step 9.

Fish Type

- 1) Select [ACCU-FISH], [Fish School], or [Bottom Fish(Only BL)], then press the **KNOB**.

For [ACCU-FISH] go to step 2). For other choices go to step 6).

- 2) Select [From] (under [Fish Type]), then press the **KNOB**.

- 3) Set the minimum fish length, then press the **KNOB**.



- 4) Select [Span] (under [Fish Type]), then press the **KNOB**.

- 5) Set the width of the alarm, then press the **KNOB**. Go to step 8.

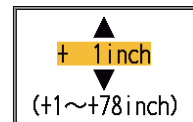

Note: The maximum measurable fish length is 78 inch.

- 6) Select [Fish Level], then press the **KNOB**.

- 7) Select the echo strength that triggers the alarm, referring to the description below.

[Weak]: Echoes stronger than light- blue* trigger the alarm.

[Medium]: Echoes stronger than yellow* trigger the alarm.

[Strong]: Echoes stronger than red* trigger the alarm.

*: When [Color Scheme] is set to [White] on the [Display] menu.

- 8) Select the [From] that is below [Depth], then press the **KNOB**.

9) Enter the width of the alarm, then press the **KNOB**.

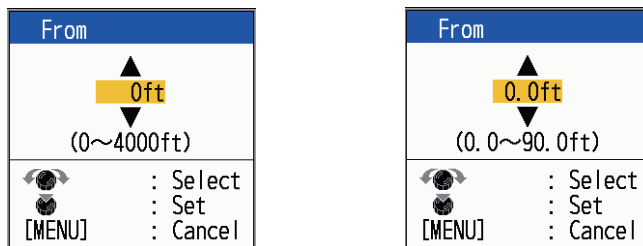

[ACCU-FISH],[Fish School] alarms [Bottom Fish (Only BL)] alarm

The alarm marker (indicated as a yellow bar at the right-hand edge of the screen) appears at the starting point for the alarm. The marker appears only when the corresponding alarm is active. The starting depth for the ACCU-FISH™ and [Fish School] alarms is the transducer position. For the [Bottom Lock] alarm the starting depth is the distance from the bottom.

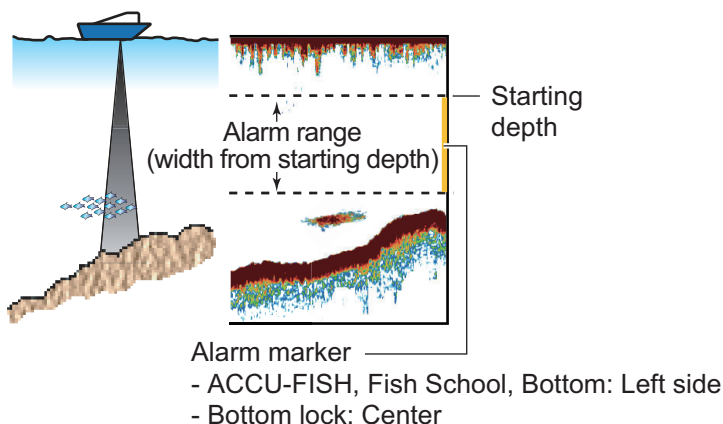

10) Select [Span], then press the **KNOB**.

11) Enter the alarm width, then press the **KNOB**.



[ACCU-FISH],[Fish School] alarms [Bottom Fish (Only BL)] alarm

The span of the yellow alarm marker decreases when [▼] is pressed and increases when [▲] is pressed.

Water temperature

- 1) Select [Inside] or [Outside] as applicable, then press the **KNOB**.
- 2) Select [From], then press the **KNOB**.
- 3) Enter the starting temperature for the alarm, then press the **KNOB**.
- 4) Select [Span], then press the **KNOB**.
- 5) Enter the width for the alarm, then press the **KNOB**.

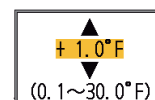
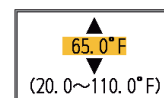

Bottom Type

Select [Rock], [Gravel], [Sand] or [Mud], then press the **KNOB**.

1. OPERATION

Bottom

- 1) Set [Bottom] to [On], then press the **KNOB**.
- 2) Select [From], then press the **KNOB**.
- 3) Set the starting depth, then press the **KNOB**.
- 4) Select [Span], then press the **KNOB**.
- 5) Set the width of the alarm, then press the **KNOB**.
11. Press the **MENU/ESC** key to show the [Fish School] setting window.
12. Select [Alarm], then press the **KNOB**.
13. Select [On], then press the **KNOB**.
14. Press the **MENU/ESC** key twice to close the window.

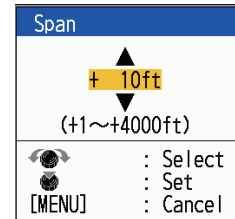
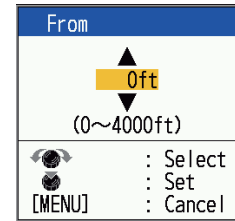

Note 1: To deactivate an alarm, select [Off] at step 13 in the above procedure.

Note 2: The default alarm settings in step 5 to step 13 can be restored. Open the [Fish Alarm] setting window, select [Reset?], press the **KNOB**, select [Yes], then press the **KNOB**.

Navigation alarms

Do the following to set the navigation alarms (speed alarm and arrival alarm).

1. Press the **MENU/ESC** key to open the menu.
2. Select [Alarm], then press the **KNOB**.
3. Select [Speed] or [Arrival], then press the **KNOB**.

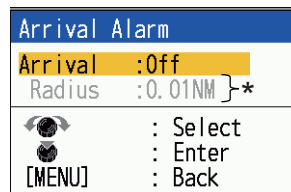
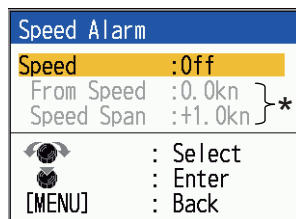

* Settable when alarm is activated.

4. Do one of the following two procedures according to the item selected at step 3.

Speed

- 1) Select [Speed], then press the **KNOB**.
- 2) Select [Inside] or [Outside] as applicable, then press the **KNOB**.
- 3) Select [From Speed], then press the **KNOB**.
- 4) Enter the starting speed, then press the **KNOB**.
- 5) Select [Speed Span], then press the **KNOB**.
- 6) Enter the width of the alarm, then press the **KNOB**.

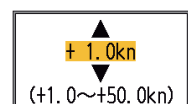
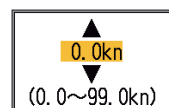

Arrival

- 1) Select [Arrival], then press the **KNOB**.
- 2) Select [Inside] or [Outside] as applicable, then press the **KNOB**.
- 3) Select [Radius], then press the **KNOB**.
- 4) Enter the alarm radius, then press the **KNOB**.
5. Press the **MENU/ESC** key twice to close the window.

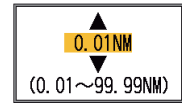

1

Note: To deactivate the alarm, select [Off] in 2) of step 4.

1.22 FUNC Key

The **FUNC** key provides for one-touch call up of desired function setting window. 13 items are available: picture advance, range shift, interference, clutter, color erase, white line, marker, WPT list, bottom zone, Zoom range, BL Range, ACCU-FISH™*1 and CHIRP preset*2. Registering a function makes operation easier. [Pic. Advance] is set as the factory default setting.

*1: Registering available only when connected to ACCU-FISH™ compatible transducer.

*2: Registering available only when connected to CHIRP transducer.

1.22.1 How to open the registered setting window

1. Short-press the **FUNC** key.
The registered setting window will be shown.

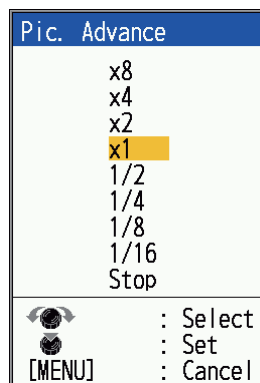

Factory default setting state

2. Rotate the **KNOB** to change the settings.
3. Press the **KNOB**.

1. OPERATION

1.22.2 How to change the function

1. Press and hold down the **FUNC** key to show the [FUNC Key] menu.

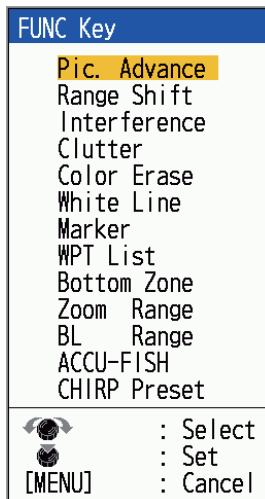

2. Rotate the **KNOB** to select a function.
3. Press the **KNOB**.

1.23 Waypoints

A waypoint can be used to mark a school of fish, reef, etc., and 20 waypoints may be entered. When a registered waypoint is set as a destination, the Nav screen can display the distance to the waypoint destination and the course information. The latitude and longitude position of the waypoint can be output to a navigation device, using the TLL sentence.

Note: The waypoint feature requires latitude and longitude position from a navigator.

1.23.1 How to register a waypoint

There are two ways to register a waypoint:

- Register a waypoint directly on the screen.
- Register a waypoint by manual entry of latitude and longitude.

How to register a waypoint directly on the screen

1. Press the **MARK** key. The cross cursor appears on the screen together with guidance on how to enter a waypoint. To register a waypoint to your current position, go to step 3.

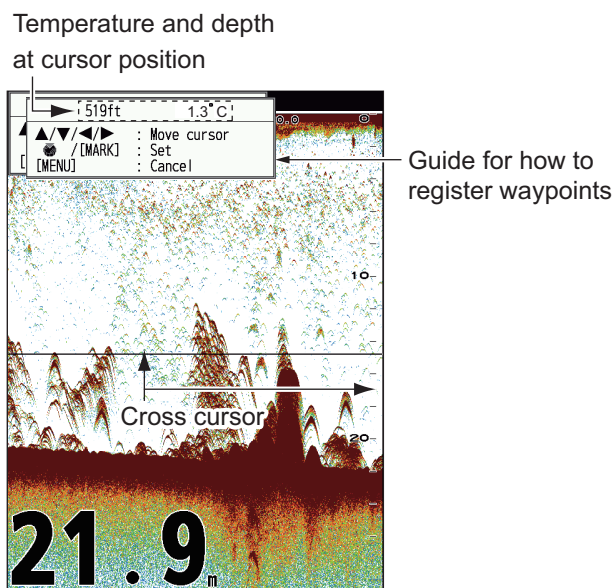

Note: If there is no position data the message "No position data!" appears. Check the navigator.

2. Press the ▲▼◀▶ to set the cross cursor where desired. Up, down for vertical movement; left, right for horizontal movement.

Note: Picture advancement is stopped until step 3 is completed.
3. Press the **MARK** key or press the **KNOB** to register the position set at step 2. A red vertical line appears on the position set at step 2. The waypoint is automatically named with the next sequential waypoint number. If you want to change waypoint name, go to step 4. Otherwise, go to step 6.

New Waypoint	
Name	: 01
Lat	: 00° 00. 012' N
Lon	: 000° 00. 012' W
Erase?	
👁	: Select
🔵	: Enter
[MENU]	: Quit

Note 1: When one of below setting is selected, the latitude and longitude position at the cursor position is output to the navigator as set in step 2.

- When [TLL] or [FURUNO-TLL] is selected at [TLL Output] window on the [NMEA0183] menu (FCV-800 only).
- When [On] is selected at [NMEA output] window on the [NMEA2000] menu.

Note 2: If you attempt to enter more than 20 waypoints, the message "Already entered 20 waypoints. No more waypoint can be entered." appears. In this case, erase an unwanted waypoint to enable entry. (See subsection 1.23.3 for details.) However, the L/L position is output to the connected equipment.

4. Press the **KNOB** to open the waypoint name entry box.
5. Enter the waypoint name (Max. 8 characters). See page 1-16 for details.
6. Press the **MENU/ESC** key to close the window.

How to register a waypoint by manual entry of latitude and longitude

1. Press the **MENU/ESC** key to open the menu.
2. Select [Data], then press the **KNOB**.

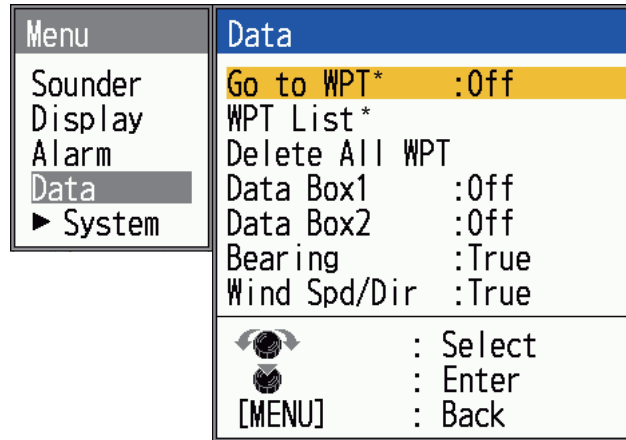

*: Not operative when no position data is input.

3. Select [WPT List], then press the **KNOB**.

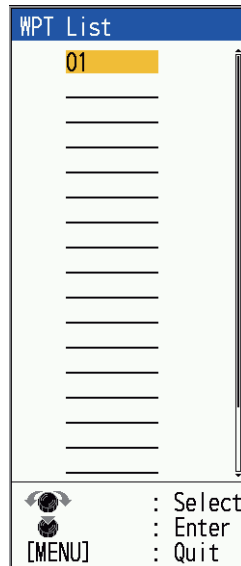

4. Select an empty waypoint, then press the **KNOB**.
The Waypoint setting window appears. [Lat] and [Lon] show the current position.
5. Select item desired, then press the **KNOB** key to show corresponding input box.
6. Enter name or latitude and longitude as applicable.

- To change the name: Select [Name] to change the waypoint name (max. 8 characters). See page 1-16 for details.
- To change latitude/longitude: Press the desired key as follows:
 - 1) Press ▲ or ▼ key to change the numerical value.
Press ▲ key to change the value 0→9...9→0→... in order.
Press ▼ key to change to the reverse order.

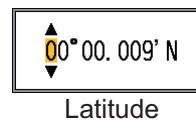

Latitude

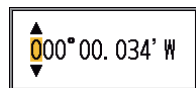

Longitude

- 2) Press ► key to move the cursor to the next character.
- 3) Repeat step 1) and 2) and set the latitude/longitude.
Use ▲ or ▼ key to change north/south and east/west value as appropriate.
- 4) Press the **KNOB**.

7. Press the **MENU/ESC** key
A waypoint is registered to the line selected in step 4.
8. Press the **MENU/ESC** key twice to close the window.

1.23.2 How to edit registered waypoints

Registered waypoints can be freely edited.

1. Press the **MENU/ESC** key to open the menu.
2. Select [Data], then press the **KNOB**.
3. Select [WPT List], then press the **KNOB**.
4. Select the waypoint to edit, then press the **KNOB**.
5. Select the item desired, then press the **KNOB**.
6. Edit data as appropriate.
7. Press the **MENU/ESC** key twice to close the window.

1.23.3 How to erase waypoints

Waypoints can be erased two ways:

- Individually
- Collectively

Note: A waypoint set as destination cannot be erased.

How to erase individual waypoints

1. Press the **MENU/ESC** key to open the menu.
2. Select [Data], then press the **KNOB**.
3. Select [WPT List], then press the **KNOB**.
4. Select the waypoint to erase, then press the **KNOB**.
5. Select [Erase?], then press the **KNOB**.
6. Select [Yes], then press the **KNOB**.
7. Press the **MENU/ESC** key twice to close the window.

1. OPERATION

How to erase all waypoints

1. Press the **MENU/ESC** key to open the menu.
2. Select [Data], then press the **KNOB**.
3. Select [Delete All WPT], then press the **KNOB**.
4. Select [Yes], then press the **KNOB**.
5. Press the **MENU/ESC** key twice to close the window.

1.23.4 How to set destination waypoint

When a registered waypoint is set as a destination, the Nav screen can display the distance to the waypoint destination and the course information (see section 1.24).

1. Press the **MENU/ESC** key to open the menu.
2. Select [Data], then press the **KNOB**.
3. Select [Go to WPT], then press the **KNOB**.
4. Select a destination waypoint, then press the **KNOB**.
5. Press the **MENU/ESC** key twice to close the window.

Note: To deactivate the waypoint, select [Off] in step 4.

1.24 Setting Up Nav Data Displays

The user may arrange the nav data displays as desired.

1. Press **▲▼◀▶** key when nav data display is shown.
Next setting window will be displayed.

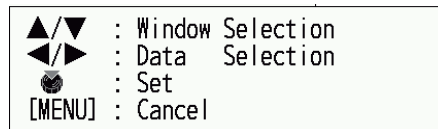

2. Use **▲** or **▼** to select a data display window desired.
Cursor is shown in yellow in currently selected data window.
3. Use **◀** or **▶** to select the item to display.
The items that can be displayed depend on the screen division.

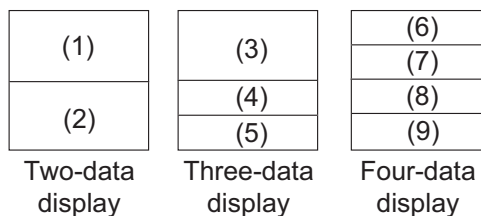

Items displayable in (1) - (3)

XTE (course), wind speed and direction, depth, atmospheric pressure

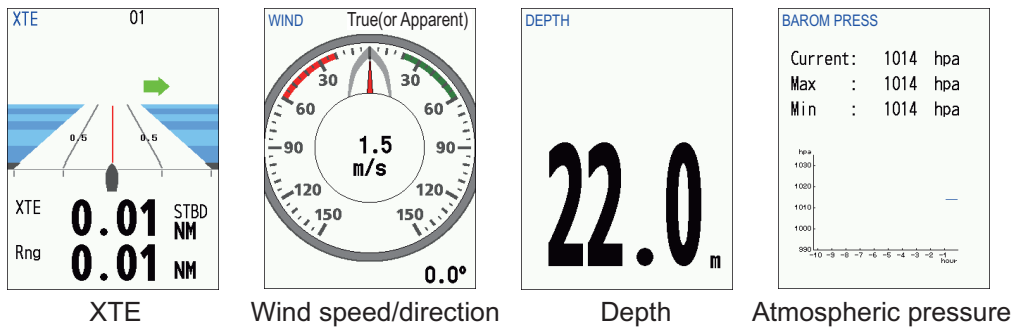

About wind speed/direction

True: Assuming the wind speed/direction when the ship is stopped (bow as standard)

Apparent: Apparent wind speed and direction, taking into account the ship's movement (bow as standard)

Abbreviations/meanings at the top of the screen

- XTE: Course deviation
- Rng: Distance to the waypoint destination
- STBD: Starboard
- Max: Maximum
- Min: Minimum

Items displayable in (4) - (9)

Depth, position (lat/lon), speed (SOG), speed (STW), COG, water temperature, heading

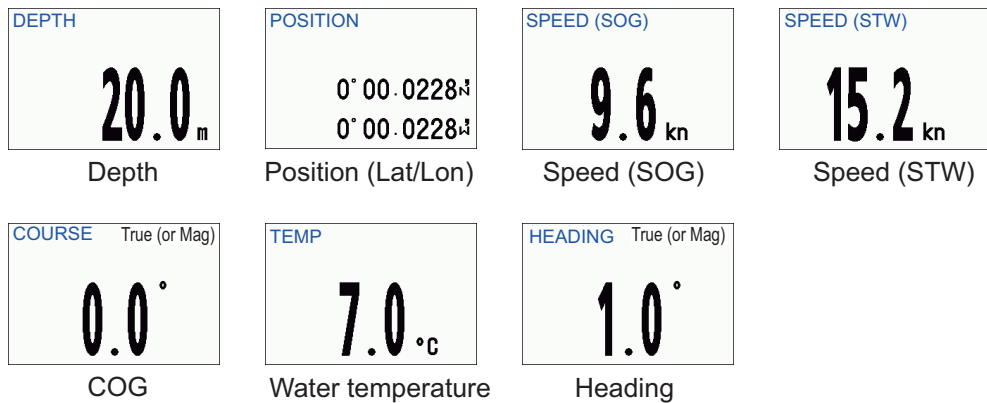

4. Press the **KNOB**.

Note 1: If necessary data is not input below items cannot be selected.

Necessary data	Item
Longitude/latitude position	Lat/Lon, course over ground (COG), XTE
Heading	Heading
Ship speed	Speed over the ground (SOG), speed through the water (STW)
Wind speed, wind angle	Wind speed, wind direction
Atmospheric pressure	Atmospheric pressure
Water temp.	Water temperature

Note 2: If data from the connected device is interrupted for 30 seconds, "- - - -" will be displayed.

1.25 Wireless LAN setup

When connected to wireless LAN, the following operations become available:

- View FCV-600 or FCV-800 fish finder images and voyage information on your iOS or Android™ device (for iOS: only one device can be connected).
- Use the FCV main unit* as a sub monitor (only one sub-monitor can be connected).
*: Wireless LAN connection between FCV-600 or FCV-800 is required.

The sub monitor displays the fish finder images of the main monitor. The sub monitor can also be used to change settings for the main monitor (only for certain functions). See the "Menu Tree" on page AP-1 for details.

Notice regarding use of wireless LAN

- The wireless LAN function is available only in the countries which have acquired radio wave certification. Turn this function off in countries which do not have radio wave certification. Ocean-going vessels that have radio wave certification can use the wireless LAN function in any country that has acquired radio wave certification. Vessels with radio wave certification that enter a country that does not have radio wave certification may use the wireless LAN function only on board the vessel. Available countries (as of January, 2022): Japan, USA, Canada, UK, New Zealand, and all countries of the EU.
- The communication rate and effective range for the wireless LAN can be affected by electromagnetic waves, interfering objects, or access point location.
- We strongly recommend using a wireless LAN with encrypted connection. Otherwise unauthorized access by a third party can occur, which can cause loss of data or system crash.
- We recommend changing the initial password when using a local wireless network.
- If wireless LAN communication fails while using the microwave oven, turn off the microwave oven.

1.25.1 Wireless LAN settings on the FCV main unit (main monitor side)

Do the following procedure when using the FCV as a standard unit or as the main monitor.

1. Press the **MENU/ESC** key to show the main menu.
2. Select [Network] and press the **KNOB**.
3. Select [Wireless LAN] and press the **KNOB**.

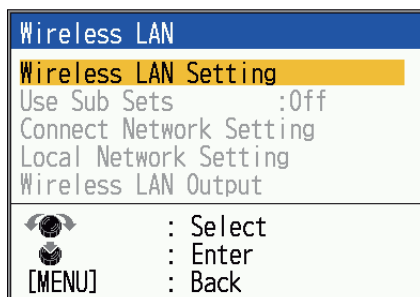

} Enabled when the [Wireless LAN] is set to [On] in the [Wireless LAN Setting] window

4. Select [Wireless LAN Setting] and press the **KNOB**.

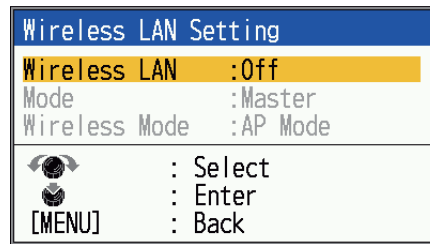

5. Select [Wireless LAN] and press the **KNOB**.
6. Select [On] and press the **KNOB**.
7. Select [Mode] and press the **KNOB**.
8. Select [Master] and press the **KNOB**.
9. Select [Wireless Mode] and press the **KNOB**.
10. Select one of the following settings and press the **KNOB**.
 - [AP Mode]: Use the FCV main unit (main monitor) as an access point.
 - [Client Mode]: Use existing access point.
11. Press the **MENU/ESC key**.
"Restart to apply changes?" message appears.
12. Select [Yes] and press the **KNOB**.
The system restarts. After restarting, if you selected "AP Mode" in step 10, a wireless LAN icon () will appear in the upper right corner of the screen. This icon indicates that the FCV is used as an access point.
13. Repeat step 1 to 3 to show the [Wireless LAN] setting window.
14. Depending on the item selected in step 10, do one of the following procedures.

For [Client Mode] (Connecting to existing FCV-600/800 units)

- 1) Select [Connect Network Setting] and press the **KNOB**.

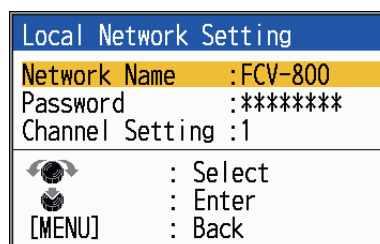

Note: In the example above, [Network Name] shows a default setting (the connected unit's name). Your network may show either FCV-600 or FCV-800, depending on your installed unit.

- 2) If you do not need to change the network, go to step 4. To change the network, select [Network Name], then press the **KNOB**. The [Network Name] window appears.
- 3) Set the desired network name (max. 32 characters). See page 1-16 for details.
- 4) Select [Password] and press the **KNOB**.
[Password] setting window will be shown.

1. OPERATION

- 5) Enter the password for the network (max. 40 characters).
Depending on the [A/*] setting, the password will appear as follows:
 - For plain text: All characters being typed are displayed.
 - For cipher text: The entered characters are displayed as "*".
- 6) If there is difficulty connecting due to high LAN activity, change the channel settings.
 - a) Select [Channel Setting] and press the **KNOB**.
 - b) Select the channel (1 to 11) and press the **KNOB**.
- 7) Press the **MENU/ESC** key.
"Restart to apply changes?" message appears.
- 8) Select [Yes] and press the **KNOB**.

For [Connect Network Setting] (Connecting to existing LAN network)

- 1) Select [Connect Network Setting] and press the **KNOB**.

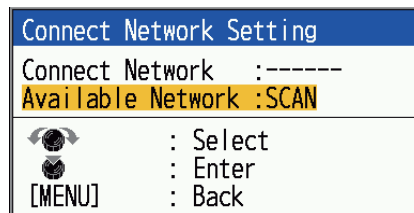

- 2) Select [Available Network] and press the **KNOB**.
When an available network near the device is detected, the name of that network name will appear in the [Network List] window.

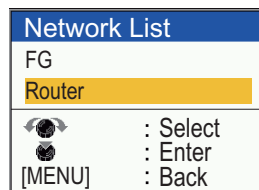



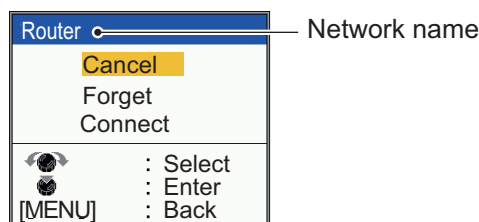

- 3) Select the network to connect and press the **KNOB**.
The following window appears.



- 4) Select [Connect] and press the **KNOB**.
[Password] setting window appears.
Note: The system stores the password for the last connected network. To erase the password and make entering a new password easier, select [Forget] before selecting [Connect]. The stored password is deleted.
- 5) Enter the password for the network and press the **KNOB**.
See page 1-16 for details. When the connection to the network is complete, the "Connecting..." message will disappear and the wireless LAN icon () will appear in the upper right corner of the screen. LAN icon indicates that an access point other than the FCV is being used. If the message "Connection failed" is dis-

played, the password you entered may be incorrect. Press the **MENU/ESC** key and repeat step 3) to 5).

Note: The number of bars on the wireless LAN icon indicates the signal strength.

Symbol	Meaning	Symbol	Meaning
3 ()	Strong	1 ()	Weak
2 ()	Average	0 ()	Extremely weak/ No connection

For sub monitor

1. Press the **MENU/ESC** key to show the main menu.
2. Select [Network] and press the **KNOB**.
3. Select [Wireless LAN] and press the **KNOB**.

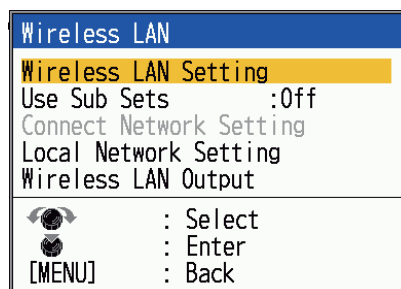

4. Select [Use Sub Sets] and press the **KNOB**.
5. Select one of the following and press the **KNOB**.
 - [On]: Reflects setting changes made on the sub monitor side to the main monitor.
 - [Off]: Do not reflect setting changes made on the sub monitor side on the main monitor.
6. Press the **MENU/ESC** key twice to close the menu.

Wireless LAN output data settings

You can share depth, navigation and weather data from the main monitor across the LAN network and display the data on the sub monitor or Android/iOS device. Do the following procedure to output depth, navigation or weather data.

1. Press the **MENU/ESC** key to show the main menu.
2. Select [Network] and press the **KNOB**.
3. Select [Wireless LAN] and press the **KNOB**.
4. Select [Wireless LAN Output] and press the **KNOB**.

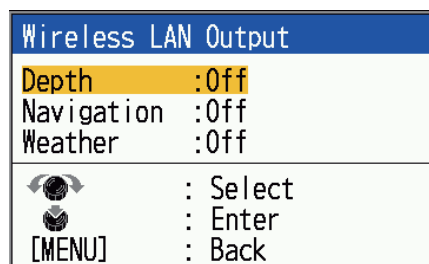

5. Select [Depth], [Navigation] or [weather] and press the **KNOB**.
6. Select [On] and press the **KNOB**.
7. Press the **MENU/ESC** key twice to close the menu.

1.25.2 Wireless LAN settings on the sub monitor side

Do the following procedure when using the FCV as a sub monitor.

1. Press the **MENU/ESC** key to show the main menu.
2. Select [Network] and press the **KNOB**.
3. Select [Wireless LAN] and press the **KNOB**.
4. Select [Wireless LAN Setting] and press the **KNOB**.
5. Select [Wireless LAN] and press the **KNOB**.
6. Select [On] and press the **KNOB**.
7. Select [Mode] and press the **KNOB**.
8. Select [Sub] and press the **KNOB**.
9. Select [Wireless Mode] and press the **KNOB**.
10. Select one of the following settings and press the **KNOB**.
 - [AP Mode]: Use the FCV main unit (main monitor) as an access point.
 - [Client Mode]: Use existing access point.
11. Press the **MENU/ESC** key.

The confirmation message "Restart to apply changes?" appears.
12. Select [Yes] and press the **KNOB**.

The system restarts. After restarting, if you selected "AP Mode" in step 10, a wireless LAN icon () will appear in the upper right corner of the screen. This icon indicates that the FCV is used as an access point.
13. Repeat step 1 to 3 to show the [Wireless LAN] setting window.
14. Depending on the item selected in step 10, continue step 11 to step 14 explained on page 1-41.

Note: Check the wireless LAN icon (bar) in the upper right corner of the sub monitor screen. It is recommended to place the unit to location with at least two bars.

1.25.3 Wireless LAN settings on the iOS or Android™ device

If you are using an iOS device or Android™, carry out the following settings.



- Network name set for the FCV main unit
- Password of the network set for the FCV main unit.

Note: The FCV and the iOS /Android™ should be connected on the same network.

1.26 Menu Description

This section describes menu items for [Sounder], [Display], [Alarm] and [Data] menu not previously mentioned. For the [System] menu, see chapter 2.

1.26.1 [Sounder] menu

Sounder	
Pic. Advance	:x1
Range Shift	:0ft
Interference	:Low
Color Erase	:0%
Clutter	:0%
Color Expand	:off
White Line	:0%
Marker	
TVG Distance	:300ft
TVG Level	:3
Smoothing	:off
Bottom Zone	
TX Power	:5
TX Rate	:10
CHIRP Preset	
	: Select
	: Enter
[MENU]	: Back

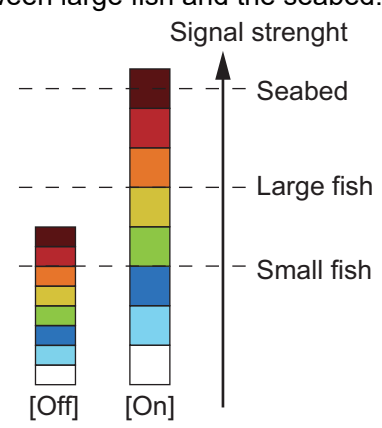
Menu item	Description
[Pic. Advance]	See section 1.11.
[Range Shift]	See section 1.10.
[Interference]	See section 1.12.
[Color Erase]	See section 1.14.
[Clutter]	See section 1.13.
[Color Expand]	<p>The echo color extension function can be used to extend the range of signal strength that can be determined by the echo color. To enable this function, select [On]. When [Off] is selected, The range of signal strength is narrow, and only small fish are indicated by color. All large fishes are indicated by brown color and making it difficult to distinguish between large fish and the seabed.</p> <p>Note 1: Depending on the software version, this function is enabled as follows.</p> <ul style="list-style-type: none"> • SW Ver. 1.06: Enabled when [Auto Gain] is set to [Off]. • SW Ver. 2.0 or later: Enabled regardless of the [Auto Gain] setting. <p>Note 2: It is recommended that this function is set to [Off] in deep water where the color of the seabed may fade. Due to the strength of reflected waves becomes weaker at greater depths, setting [Echo Expand] to [On] at greater depths will result in a lighter overall echo color, and the seabed will no longer be brown.</p> <p>Note 3: When this function is set to [On], the fish school response is weakened at deeper depths and the fish school alarm and the fish school on the bottom alarm may not be activated.</p>  <p>The diagram illustrates signal strength levels. A vertical axis labeled 'Signal strength' has an upward-pointing arrow. Three horizontal dashed lines indicate levels for 'Seabed', 'Large fish', and 'Small fish'. Two vertical color bars represent the [Off] and [On] settings. The [Off] bar shows a narrow range of colors (brown, red, orange, yellow, green, blue, cyan, white) corresponding to the seabed, large fish, and small fish levels. The [On] bar shows a wider range of colors (brown, red, orange, yellow, green, blue, cyan, white) corresponding to the same levels, indicating that the [On] setting extends the range of signal strength.</p>

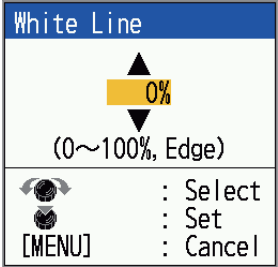
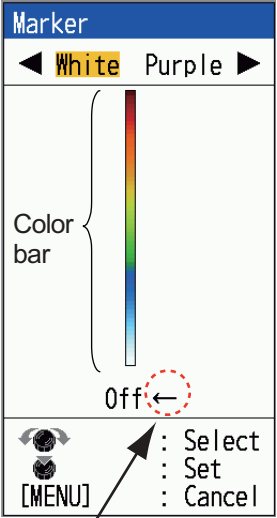
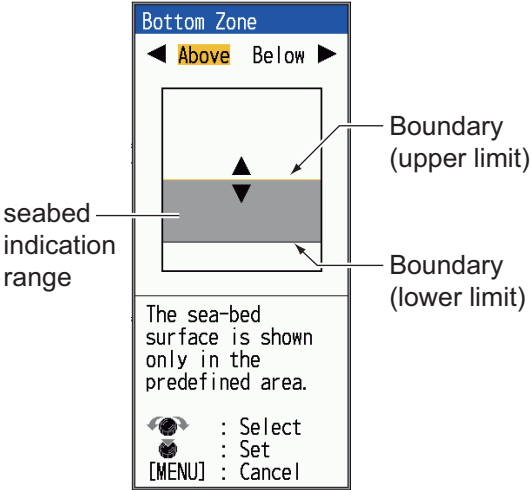

1. OPERATION

Menu item	Description
[White Line]	<p>The white line function makes it easy to distinguish between bottom fish from the seabed. The strongest colors (seabed, large schools of fish, dense schools of fish, etc.) are shown with a white outline. Not only is it useful for identifying seabed and bottom fish but also to determine the density of the fish school.</p> <ol style="list-style-type: none"> 1) Select [White Line], then press the KNOB. 2) Set the width. The larger the number the greater the width of the line. Select [Edge] to show the contour of the bottom in white. 3) Press the KNOB. 
[Marker]	<p>Display the selected echo color in white.</p> <ol style="list-style-type: none"> 1) Select [Marker], then press the KNOB. 2) Press ◀ or ▶ key to select [White] or [Purple]. 3) Use ▲ or ▼ key or rotate the KNOB to select color desired. For example, move the arrow to the top of the color bar to display the bottom echo in white. The echo color chosen on the color bar is changed to white. That color is also white on the color bar. 4) Press the KNOB. <p>Note: To change from white (or purple) to the original color, move the arrow to the bottom [Off], then press the KNOB.</p>  <p>Select echo color displayed in white or purple.</p>
[TVG Distance]	See section 1.20.
[TVG Level]	
[Smoothing]	Smooth echo presentation when enabled. Turn smoothing to [On] when echoes appear "spotty" or "jagged".
[Bottom Zone]	<p>Set the area where to display the bottom echo when selecting the [Auto] mode on the RANGE key.</p> <p>Note: The bottom discrimination feature must be disabled to use this feature.</p> <ol style="list-style-type: none"> 1) Select [Bottom Zone], then press the KNOB. 2) Use ◀ or ▶ key to select the border desired ([Above] or [Below]). 3) Use ▲ or ▼ or rotate the KNOB to move upper or lower border. 4) Press the KNOB. 

Menu item	Description
[TX Power]	Interference may appear on the screen when an echo sounder having the same frequency as your own is being operated in the vicinity of your vessel. In this case, lower your TX power and contact the vessel to request them to reduce their TX power. The lower the numeric (percentage) the lower the TX power. The [Off] setting disables transmission. Note: Only available when the bottom discrimination or ACCU-FISH™ function is disabled.
[TX Rate]	Change pulse repetition rate. Normally, the highest rate (10) is used. When in shallow waters second reflection echoes may appear between the surface and actual bottom echo. In this case, lower the TX rate level. The setting [MAX] automatically adjusts the frequency and pulse length with depth. The [S] setting, which requires speed data, selects the TX rate according to your boat's speed. A high rate for fast speed; a slow rate for slow speed.
[RezBoost]	See section 1.19.
[CHIRP Preset]	Displays the [CHIRP Preset] setting window (see below). This window appears only when a CHIRP transducer is connected.

[CHIRP Preset] settings

When connecting a CHIRP transducer, the frequency of the transducer can be freely set in advance (up to 3 patterns).

CHIRP Preset	
Select	: 1
TX Mode HF	: Auto CHIRP
Center Freq.	: 200kHz
CHIRP Width	: 50kHz
TX Mode LF	: Auto CHIRP
Center Freq.	: 53kHz
CHIRP Width	: 22kHz
	: Select
	: Enter
[MENU]	: Back



*: Items displayed depend on the type of the connected transducer.

Menu Item	Description
[Select]	Select the preset number (1 to 3).
[TX Mode HF/LF]	Select high freq. or Low freq. TX Mode. <ul style="list-style-type: none"> • [Auto CHIRP]: The center frequency and width of CHIRP is automatically adjusted based on depth. • [Manual CHIRP]: The center frequency and width of CHIRP is set manually. • [CW]: Selected when deeper depth want to be observed.
[Center Freq.]	Set the center frequency. Active when [Manual CHIRP] or [CW] is selected in the [TX Mode HF/LF] setting.
[CHIRP Width]	Set the CHIRP width. Active when [Manual CHIRP] is selected in the [TX Mode HF/LF] setting.

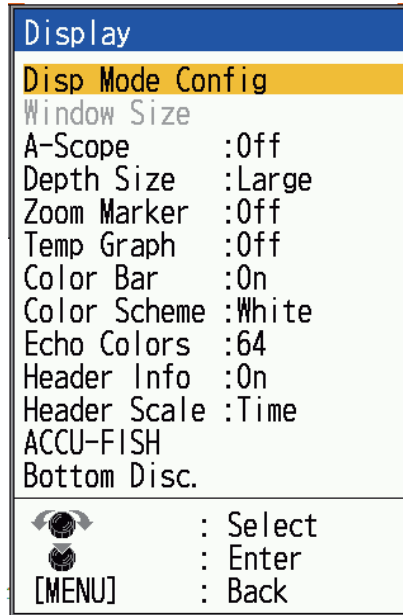
1.26.2 [Display] menu

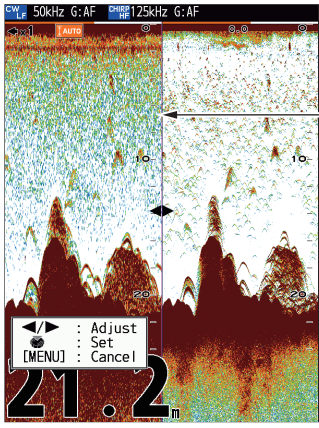

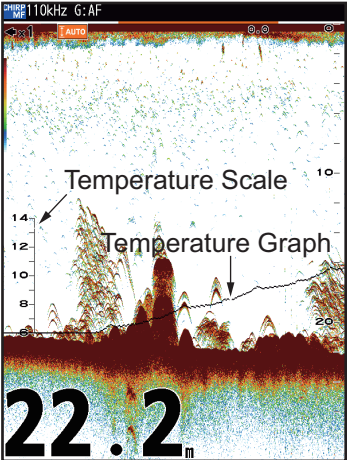
Menu Item	Description
[Disp Mode Config]	See subsection 1.5.6.
[Window Size]	<p>Adjust the display area of the dual frequency mode or zoom mode. Note: This function is inoperative with the single frequency, nav data mode or A-scope display.</p> <p>1) Select [Window Size], then press the KNOB.</p>  <p>Dividing line</p> <p>2) Use ◀ or ▶ to move the dividing line, then press the KNOB.</p>
[A-Scope]	See section 1.15.
[Depth Size]	Select the font size of the depth indication ([Small], [Medium], [Large] or [Off]).
[Zoom Marker]	<p>Turn the zoom marker on or off (on the single frequency display) when the bottom lock display, the bottom zoom display or the marker zoom display is active.</p> <p>Note: When using sub monitor, set [Depth] in the [Wireless LAN Output] menu to [On] on the main monitor side (see page 1-43). If [Depth] is set as [Off], zoom marker does not appear on the single frequency display even when [Zoom Marker] is set to [On] on the sub monitor side (Bottom Discrimination screen only).</p>

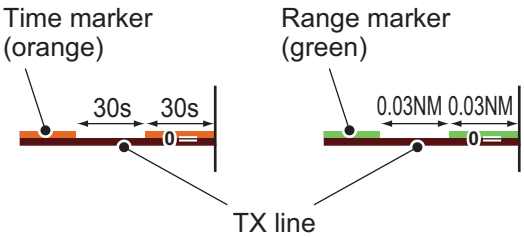
Menu Item	Description
[Temp Graph]	<p>Turn the water temperature graph on or off. The temperature scale range is 16°(°F) in [Narrow]; 40°(°F) in [Wide]. Requires water temperature data.</p> 
[Color Bar]	Turn the color bar on or off.
[Color Scheme]	<p>Change the background color of the screen to suit surroundings. The choices are white, blue, black, yellow* and sunlight*. *:The strongest color will be black/green, not the background color. These colors are easy to see even under sunlight.</p>
[Echo Colors]	<p>Select amount of colors for [Color Bar] and response colors (8,16 or 64 colors). When [Echo Colors] setting is changed, the colors available at [Marker] in the [Sounder] menu will also change.</p>
[Header Info]	<p>Turn the operational info display (appears at the top on the screen) on or off.</p> <ul style="list-style-type: none"> • [On]:The header info is always displayed. • [Off]: When the KNOB is pressed while the menu or setting window is hidden, the header area appears for 3 seconds.  <p style="text-align: center;"><i>Header info</i></p>
[Header Scale]	<p>The header scale (below the header info) provides an estimate of time or distance.</p> <ul style="list-style-type: none"> • Time: An orange bar and a “blank” bar scroll across the screen for 30 seconds each. (One set is one minute.) • Distance: An orange bar and a “blank” bar scroll across the screen. Each bar is equal to 0.03 NM. (One set is 0.06 NM.) Requires either speed or position data. 
[ACCU-FISH]	See section 1.17.
[Bottom Dis.]	See section 1.18.

1. OPERATION

1.26.3 [Alarm] menu

The [Alarm] menu allows you to make settings related to alarms. For a description of each item, see section 1.21.

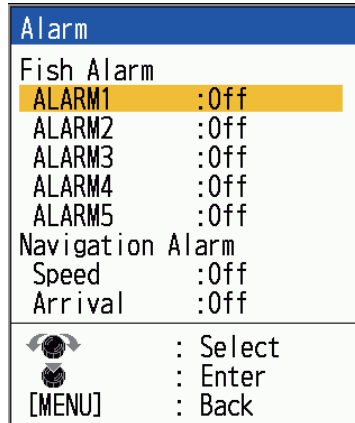

1.26.4 [Data] menu

This menu mainly sets up how to display data input by external equipment.

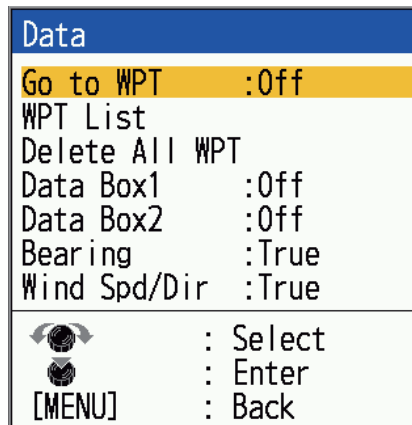

Menu Item	Description
[Go to WPT]	See section 1.23.
[WPT List]	
[Delete All WPT]	
[Data Box1]	Show or hide the Data Box1, Data Box2 indication, which appears below the header info. You can select multiple indications (SOG, STW, position, heading, volt, water temperature, heave). Requires appropriate data.
[Data Box2]	
[Bearing]	Select the format of bearing display, [True] or [Mag](netic).
[Wind Spd/Dir]	Select the format of wind speed and direction output from a wind sensor, [True] or [Apparent].



2. SYSTEM MENU

2.1 How to Display the System Menu

The [System] menu mainly consists of items which do not require regular adjustment.

1. Press the **MENU/ESC** key to open the menu.
2. Rotate the **KNOB** to show the [System] menu.

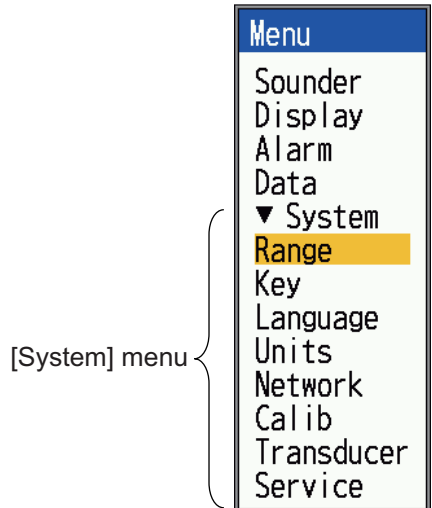

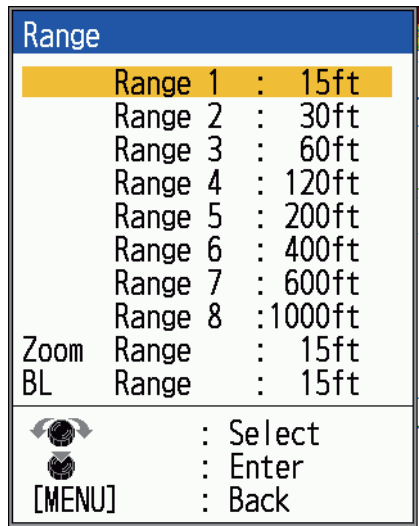

2.2 [Range] Menu





Menu Item	Description
[Range 1] - [Range 8]	Set range of each of the eight ranges (available range: 7 to 4,000 ft).
[Zoom Range]	Select the range to zoom in the bottom zoom and marker zoom.
[BL Range]	Select the expansion width for the bottom lock display.

2.3 [Key] Menu

Key	
FUNC Key	:Pic. Advance
Key Beep	:On
	: Select
	: Enter
[MENU]	: Back



Menu Item	Description
[FUNC key]	Select the item to program to the FUNC key. The programming can also be done by long-pressing the FUNC key. See subsection 1.22.2.
[Key Beep]	Turn key beep on or off.

2.4 [Language] Menu

Language	
Language	:English
	: Select
	: Enter
[MENU]	: Back

Menu Item	Description
[Language]	The system language is available in English, European and Asian languages. To change the language, select the appropriate language, then press the KNOB .

2.5 [Units] Menu

Units	
Depth	:ft
Temp	:°F
Fish Size	:inch
Speed	:kn
Wind	:kn
Distance	:NM
	: Select
	: Enter
[MENU]	: Back

Menu Item	Description
[Depth]	Select unit of depth measurement.
[Temp]	Select unit of water temperature measurement.
[Fish Size]	Select unit of fish size measurement.
[Speed]	Select unit of speed measurement.
[Wind]	Select unit of wind speed measurement.
[Distance]	Select unit of distance measurement.

2.6 [Network] Menu

The [Network] menu consists of the [Sensor In Use], [Data Source], [NMEA0183] (FCV-800 only), [NMEA2000], and [Wireless LAN] setting windows. For more information about [Wireless LAN] setting window, please refer to section 1.25.

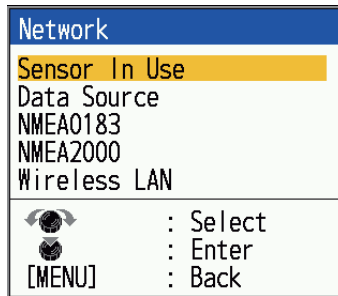

2

2.6.1 [Sensor In Use] window

The [Sensor In Use] allows you to see the data sources of the sensors currently in use. If data cannot be output, [-----] will be shown.

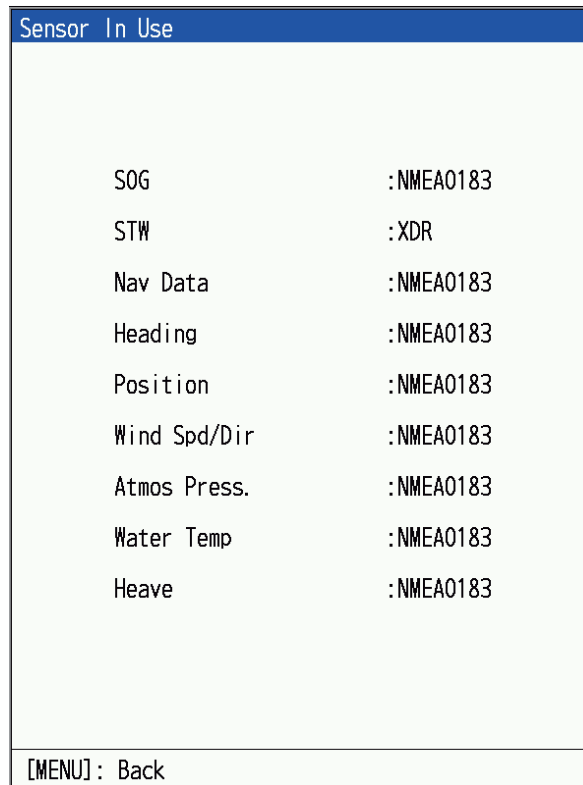

2.6.2 [Data Source] setting window

The [Data Source] setting window allows you to adjust settings related to various data sources.

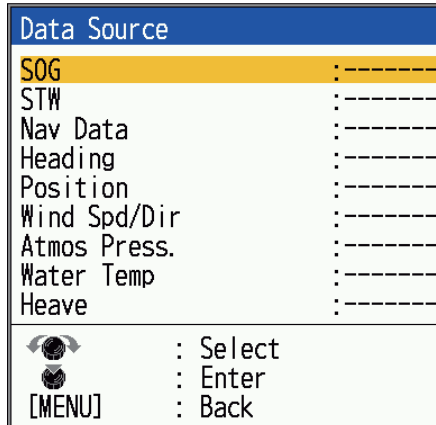

Menu Item	Description
[SOG]	<p>Select the sensor to use as data source for SOG, STW, Nav Data, heading, position, wind Spd/Dir, atmospheric pressure, water temperature and heave.</p> <p>1) Turn on all connected sensors.</p> <p>2) Select the desired data for data source and press the KNOB. The data source selection window appears. The figure on the right shows an example of when [Heading] is selected.</p> <p>3) Select one of the following data sources and press the KNOB. The choices displayed in the data source selection window depend on the selection of step 2) above.</p> <ul style="list-style-type: none"> • [-----]: Unselected. • [NMEA0183] (FCV-800 only): Import data from the NMEA0183 device connected to the [PWR/KP/NMEA0183] port. • [XDR], [XDR1] (FCV-800 only): Import data from the transducer connected to the [XDR] (FCV-600) or [XDR1] (FCV-800) port. • [XDR2] (FCV-800 only): Import data from the transducer connected to the [XDR2] port. • NMEA2000 device name/ CAN ID: Import data from the NMEA2000 device connected to the [NMEA2000] port. If multiple devices are connected to the same network, the names of all devices will be displayed. Select the device to be used as the data source. <p>4) Repeat step 2) and 3) to set all data sources.</p>
[STW]	
[Nav Data]	
[Heading]	
[Position]	
[Wind Spd/Dir]	
[Atmos Press.]	
[Water Temp]	
[Heave]	

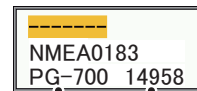

NMEA2000 device name
CAN ID name

2.6.3 [NMEA0183] window (FCV-800 only)

If you have navigation equipment or other devices connected to the [PWR/KP/NMEA0183] port, make the necessary settings in the [NMEA0183] window.

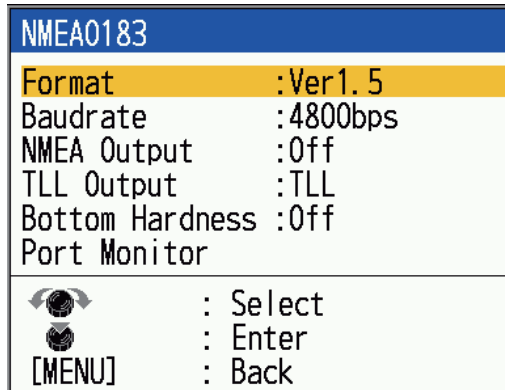

Menu Item	Description
[Format]	Select the version of nav equipment connected to [PWR/KP/NMEA0183] port.
[Baudrate]	Select [4800bps] or [38400bps] for the baudrate.
[NMEA Output]	Select what data sentences to output. <ul style="list-style-type: none"> • [Off]: Do not output the NMEA0183 data sentences. • [On]: Output the NMEA0183 data sentences. However, data is not output from other nav equipments.
[TLL Output]	Output the position specified by the MARK key to the plotter connected. <ul style="list-style-type: none"> • [Off]: Do not output latitude/longitude. • [TLL]: Output latitude/longitude. • [FURUNO-TLL]: Output latitude/longitude, depth, water temperature, fish information, bottom discrimination data (requires [FURUNO-TLL] enabled device).
[Bottom Hardness]	Shown only when the transducer that supports hardness* is connected. Select [On] to output the hardness sentence (Sdbhr). *: See the equipment list on page AP-5.
[Port Monitor]	Sentence information entered into the [PWR/KP/NMEA0183] port can be checked. To display the latest sentence information, press the KNOB . <div style="border: 1px solid black; padding: 5px; margin: 10px 0;"> <p>Port Monitor</p> <pre>\$GPGGA,095354.76,0959.673,S,09959.59,W,0.00,0.0,0.0,M,0.0,M,0.0,0.0,0000*44*6E<0d><0a> \$GPGLL,3442.67330,N,13520.59237,E,095354.92,A,A*63*4C<0d><0a> \$GPGNS,095355.03,3443.4,N,13521.4,E,A,00,0.0,0.0,0.0,0.0*0*3F*60<0d><0a> \$GPHDG,255.00000,0.0,E,0.0,E*5C*00<0d><0a> \$GPHDT,255.00000,T*37*19<0d><0a> \$GPMTW,9.00000,C*3D*60<0d><0a> \$GPMWV,180.00000,R,10.00000,K,A*17*3B<0d><0a></pre> <p> : Clear Window [MENU] : Quit</p> </div>

2.6.4 [NMEA2000] window

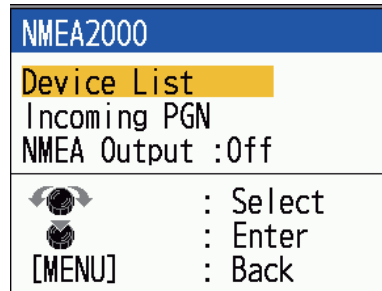

The [NMEA2000] window allows you to view the information/reception status of NMEA2000 devices that are on the same NMEA2000 network as the unit. You can also change the NMEA2000 output settings here.



Menu Item	Description																														
[Device List]	<p>The [Device List] window lists the devices on the NMEA2000 network. Select a device name and press the KNOB. The [Device Info] window appears, displaying information about the device.</p> <div style="display: flex; align-items: center; justify-content: center;"> <div style="border: 1px solid black; padding: 5px; margin-right: 20px;"> <p style="text-align: center; background-color: #0056b3; color: white; margin: 0;">Device List</p> <p style="background-color: #ffff00; margin: 0;">Refresh</p> <p>FCV-800 : 2097151</p> <p>PG-700 : 0026844</p> <p style="font-size: small;">: Select : Enter [MENU] : Back</p> </div> <div style="margin-right: 20px;"> <p>Select the device name</p> <p>→</p> </div> <div style="border: 1px solid black; padding: 5px;"> <p style="text-align: center; background-color: #0056b3; color: white; margin: 0;">Device Info</p> <p style="background-color: #ffff00; margin: 0;">Device Name : PG-700</p> <p>Can Unique ID : 26844</p> <p>Can Address : 2</p> <p>Device Instance : 0</p> <p>System Instance : 0</p> <p style="font-size: small;">: Select : Enter [MENU] : Back</p> </div> </div> <p>The [Device Instance] and [System Instance] numbers can be changed as needed. Note: If you want to update the information, select [Refresh] in the [Device List] window.</p>																														
[Incoming PGN]	<p>The [Incoming PGN] window lists the PGNs that can be received by the unit. Received data is shown in black, and unreceived data is shown in gray (updated in one-second cycles). The middle section of the window shows the name of the PGNs that is selected by the selection cursor (yellow).</p> <div style="display: flex; align-items: center; justify-content: center;"> <div style="margin-right: 20px;"> <p>PGN information →</p> </div> <div style="border: 1px solid black; padding: 5px;"> <p style="text-align: center; background-color: #0056b3; color: white; margin: 0;">Incoming PGN</p> <table style="width: 100%; border-collapse: collapse; font-size: small;"> <tr> <td style="background-color: #ffff00;">059904</td> <td>060928</td> <td>061184</td> <td>065240</td> <td></td> </tr> <tr> <td>065280</td> <td>126208</td> <td>126720</td> <td>126992</td> <td>126996</td> </tr> <tr> <td>127250</td> <td>127252</td> <td>127257</td> <td>128259</td> <td>129025</td> </tr> <tr> <td>129026</td> <td>129029</td> <td>129283</td> <td>129284</td> <td>130306</td> </tr> <tr> <td>130310</td> <td>130311</td> <td>130312</td> <td>130314</td> <td>130316</td> </tr> <tr> <td>130577</td> <td>130821</td> <td></td> <td></td> <td></td> </tr> </table> <p style="margin-top: 5px;">ISO Acknowledgement</p> <p style="font-size: small;">: Select [MENU] : Back</p> </div> </div>	059904	060928	061184	065240		065280	126208	126720	126992	126996	127250	127252	127257	128259	129025	129026	129029	129283	129284	130306	130310	130311	130312	130314	130316	130577	130821			
059904	060928	061184	065240																												
065280	126208	126720	126992	126996																											
127250	127252	127257	128259	129025																											
129026	129029	129283	129284	130306																											
130310	130311	130312	130314	130316																											
130577	130821																														
[NMEA Output]	<p>Adjust output settings to NMEA2000 devices.</p> <ul style="list-style-type: none"> • [Off]: 128259, 128267, 130310, 130312, 130316, 130830, 130831, 130832 PGNs are not output. • [On]: 128259, 128267, 130310, 130312, 130316, 130830, 130831, 130832 PGNs are output. 																														

2.7 [Calib] Menu

The [Calib] menu allows you to make corrections for water temperature, speed, water type etc. Refer to the setting ranges and guides in the window.

Calibration	
Draft	:+0.0ft
Gain Adj CHIRP MF	:+0
Gain Adj CW HF	:+0
Gain Adj CW LF	:+0
Temp	:+0.0°F
Speed (STW)	:+0%
Fish Size	:+0%
Water Type	:Salt
Zero Line	
Rejector	:On
Area	:4.5ft
Bottom Detect	:0.0ft
Bottom Level XDR1	:+0
Bottom Level XDR2	:+0
Bottom Hardness	:+0
Heave Sensor Setting	
	: Select
	: Enter
[MENU]	: Back

2

Menu Item	Description
[Draft]	The default depth display shows the distance from the transducer. If you would rather show the distance from the sea surface, set your ship's draft.
[Gain Adj CHIRP HF/LF/MF]*1	If the gain is too high or too low, or the gain for the low and high frequencies appears unbalanced, you can compensate it here.
[Gain Adj CW HF/LF]*1	
[Temp]	If the water temperature indication is wrong, you can correct it here. For example, if the water temperature indication is 2° higher than actual water temperature, enter -2.
[Speed (STW)]	If the speed indication is wrong, you can correct it here. For example, if the speed indication is 10% lower than actual speed, enter +10.
[Fish Size]	Compensate for wrongful indication of fish size.
[Water Type]	Select the water type with which to use the equipment, from [Salt] or [Fresh]. Select correct water type to get accurate depth data.
[Zero line] [Rejector]	Turn the zero line (transmission line) on or off. When turned on, the transmission line disappears, which allows you to see fish echoes near the surface clearly. The length of the transmission line changes with transducer used and installation characteristics. If the width of the transmission line is 4.5 ft (default value) or more, set the transmission line width with [Zero Line Area], as below.
[Zero Line] [Area]	This feature adjusts the transmission line so that the transmission line disappears when the menu item [Zero Line Rejector] is turned on. For a long tail, increase the value. If the transmission line does not disappear, lower the TX power.
[Bottom Detect]	In some installations the tail of the TX line or the echo afterglow can be mistaken for the bottom echo. If this occurs, raise this setting to solve the problem. Too low a setting may prevent display of the bottom echo.

2. SYSTEM MENU

Menu Item	Description
[Bottom Level XDR]*2	In the default bottom level setting (+0), the equipment judges consecutive strong echoes to be bottom echoes. If, in that setting, the depth indication is unstable, adjust the bottom level. If vertical lines extend upward from the bottom echo in the bottom lock display, lower the bottom level to erase the vertical lines. Note: If the level is too low, however, it may be difficult to distinguish bottom fish from the bottom echo. Pay a close attention to the actual echo when adjusting settings.
[Bottom level XDR1*3/ XDR2]*3	
[Bottom Hardness]*3	Corrects the hardness value output by NMEA0183.
[Heave Sensor Settings]	Shows the [Heave Sensor Settings] window (see below for details).

*1: Items displayed will vary depending on the connected transducer.

*2: Displayed only for FCV-600. *3: Displayed only for FCV-800.

[Heave Sensor Settings] window



Note 1: Satellite Compass™ connection is required to use the heave sensor function. If no hull information is input from the Satellite Compass™, the heave sensor function is disabled.

Note 2: If the [External KP] in the [Transducer] menu is set to [On], the heave sensor function is disabled (FCV-800 only).

Note 3: Use of NMEA data converter (NMEA0183 to NMEA2000) is not recommended.

Note 4: To use the heave sensor function, set the Satellite Compass™ output data as follows. For details, refer to the desired Operator's manual.

	NMEA0183	NMEA2000
Output sentence	ATT (GPatt), HVE (GPhve)	-
Baudrate	38,400bps	-
Output cycle	Lower than 25ms	-
Version	IEC ED1 (SC-50/110 only)	-
PGN	-	Heave: 65280 Attitude: 127257

Heave Sensor Setting	
Heave Calib	:0n
Heave Sensor Delay	:10
Heave Sensor Position(SC)	
XDR1 Position	
XDR2 Position	
	: Select
	: Enter
[MENU]	: Back

Menu Item	Description
[Heave Calib]	Select whether or not to enable the heave sensor function. When this function is set to [On], the shape of the seabed will be displayed stably even in rough sea conditions.
[Heave Sensor Delay]	Enabled when [On] is selected for [Heave Calib] above. Set the delay value. If seabed is not shown steadily even if position is set correctly, adjust the value while observing the display. The recommended value is 10 ms.

Menu Item	Description
[Heave Sensor Position (SC)]	Position of the Satellite Compass™ set at installation. DO NOT change this setting. Note: Changing the setting causes inefficient performance.
[XDR Position]*1 [XDR1 Position]*2/ [XDR2 Position]*2	Transducer position; set at installation. DO NOT change this setting. Note: Changing the setting causes inefficient performance.

*1: Displayed only for FCV-600.

*2: Displayed only for FCV-800.

2.8 [Transducer] Menu

The [Transducer] menu allows you to set the transducer connected to the unit. It also sets the external KP device (FCV-800 only).

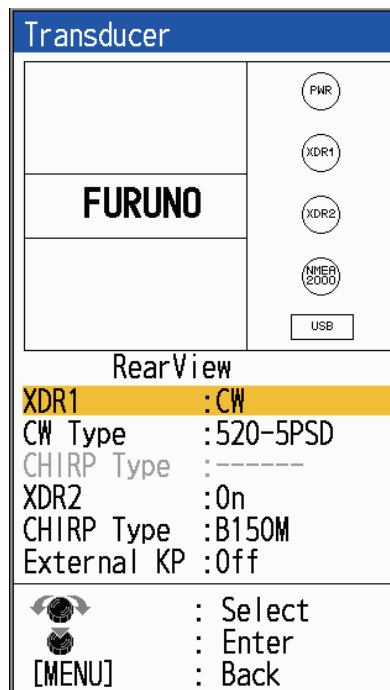

Menu Item	Description
[XDR]*1	Select the type of transducer connected to the [XDR] or [XDR1] port (CW transducer/ CHIRP transducer). If no transducer is connected, select [Off].
[XDR1]*2	
[CW Type]	Enabled when [CW] is selected for [XDR] or [XDR1] above. Select the type of transducer connected to the [XDR] or [XDR1] port.
[CHIRP Type]	enabled when [CHIRP] is selected for [XDR] or [XDR1] above. Select the type of transducer connected to the [XDR] or [XDR1] port.
[XDR2]*2	When transducer is connected to the [XDR2] port, select [On].
[CHIRP Type]*2	Enabled when [On] is selected for [XDR2] above. Select the type of transducer connected to the [XDR2] port.
[External KP]*2	Select [On] for KP unit with external sounder transmission equipment.

*1: Displayed only for FCV-600.

*2: Displayed only for FCV-800.

2.9 [Service] Menu

The [Service] menu allows you to do the following operations.

- Tankenmaru* settings
- Unit diagnostic test
- Export/import menu settings
- Demo mode (On/Off)

*: Not available outside Japan.

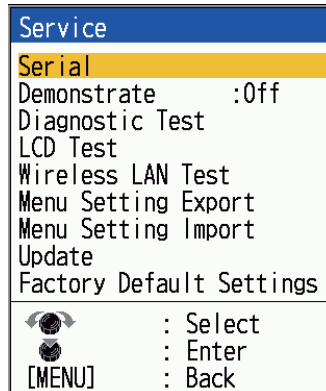



Menu Item	Description
[Serial]	Shows the [Serial] settings window (see below).
[Demonstrate]	<p>The demonstration mode provides, without connection of the transducer, simulated operation of the equipment, using internally generated echoes. All controls are operative. The message [DEMO] appears at the bottom right corner on the screen when the demonstration mode is active.</p> <ul style="list-style-type: none"> • [Off]: Deactivate the demonstration mode. • [Demo1]: Show the demonstration of CW and CHIRP. • [Demo2]: Show the demonstration of dual frequency CHIRP. • [Demo3]: Show the demonstration of RezBoost™.
[Diagnostic Test]	See section 3.5 for details.
[LCD Test]	See section 3.6 for details.
[Wireless LAN Test]	See section 3.7 for details.
[Menu Setting Export]	<p>Menu settings can be exported to USB flash memory.</p> <ol style="list-style-type: none"> 1) Open the USB port cover on the back of the unit and insert the USB flash memory. 2) Select [Menu Setting Export], then press the KNOB. 3) Select [Yes], then press the KNOB. <p>"Settings Exporting..." message is displayed during exporting. When exporting is completed, "FCV600_800_setting" folder will be created directly under the USB flash memory (only if there is no corresponding folder). Below files will be created.</p> <ul style="list-style-type: none"> • Setting file (FCV600_800.txt): If "FCV600_800.txt" already exists, the file will be overwritten. • Backup file of the setting file (FCV600_800_01 (- 99) .txt): If "FCV600_800_01.txt" already exists, "FCV600_800_02.txt" will be created. <p>Note 1: If the USB flash memory is not inserted, the message "USB storage is not inserted" will be displayed.</p> <p>Note 2: If the above operation is used when "FCV600_800_99.txt" backup file exists, the message "File cannot be created" will appear. Delete the unnecessary backup files.</p>

Menu Item	Description
[Menu Setting Import]	Menu settings can be imported from USB flash memory. 1) Open the USB port cover on the back of the unit and insert the USB flash memory. 2) Select [Menu Setting Import], then press the KNOB . 3) Select [Yes], then press the KNOB . The system will restart automatically. Note: If the USB flash memory is not inserted, the message "USB storage is not inserted" will be displayed.
[Update]	Used for software updates.
[Factory Default Settings]	See section 3.8 for details.

[Serial] setting window

The [Serial] setting window is used to adjust settings related to Tankenmaru* function. Tankenmaru and is a system that wirelessly transmits fish finder data from this unit (main unit) to a sub unit. The wireless transmitter and the sub-unit are made by Shimano. To use Shimano units please refer to the Shimano's operation manual.

*: Not available outside Japan.

Serial	
Format	: Off
Pic. Sync	: Yes
Sub Clutter	: 4
Start Depth	: 0m
Period	: 1sec
Resolution	: Auto
Data Type	: Peak
	: Select
	: Enter
[MENU]	: Back

Menu Item	Description
[Format]	[Off] selected as default. Do not change the settings. Note: [Echo] for [Format] is a special setting for researchers only. Do not select this setting for normal use. When [Echo] is selected, echo data is output from the [PWR/NMEA0183] (FCV-600) or [PWR/KP/NMEA0183] (FCV-800) port. However, the echo data will not be received from the navigation equipment.
[Pic Sync]	Not available outside Japan.
[Sub Clutter]	
[Start Depth]	For researchers only.
[Period]	
[Resolution]	
[Data Type]	

2. SYSTEM MENU

This page is intentionally left blank.

3. MAINTENANCE, TROUBLE-SHOOTING

⚠ WARNING

ELECTRICAL SHOCK HAZARD
Do not open the equipment (other than when installing flush mount hanger cover).

Only qualified personnel can work inside the equipment.

NOTICE

Do not apply paint, anti-corrosive sealant or contact spray to coating or plastic parts.

Those items contain organic solvents that can damage coating and plastic parts, especially plastic connectors.

3.1 Maintenance

Regular maintenance is essential for good performance. Check the items listed in the table below monthly to help keep your equipment in good shape for years to come.

Checking

Item	Check	Action
Transducer cable	Check the cables are securely connected and not damaged.	<ul style="list-style-type: none"> • Connect the cable if loosened. • Replace the cable if damaged.
Connector	Check for looseness and rust.	<ul style="list-style-type: none"> • Refasten if necessary. • Remove rust if necessary.
Ground terminal	Check the ground terminal is not loosened or rusty and that the ground wire is properly grounded.	
Cabinet	Check the cabinet for dust and dirt.	Dust or dirt may be removed from the cabinet with a soft cloth. Water-diluted mild detergent may be used if desired. DO NOT use chemical cleaners to clean the display unit; they may remove paint and markings.
LCD	Check the LCD surface for dust and dirt.	Wipe the LCD carefully to prevent scratching, using the cleaning cloth provided and an LCD cleaner. To remove dirt or salt deposits, use an LCD cleaner, wiping slowly with cleaning cloth so as to dissolve the dirt or salt. Do not use solvents such as thinner, acetone or benzene for cleaning. Also, do not use degreaser or antifog solution on the LCD, as they can strip the coating on the LCD.
Transducer	Marine life on the face of the transducer will result in a gradual decrease in sensitivity. Check the face of the transducer regularly for cleanliness.	<ul style="list-style-type: none"> • Clean off any deposits on the transducer surfaces. • Carefully remove any marine life with a piece of wood or fine-grade sandpaper. • DO NOT use chemical cleaners to clean the transducer.

3.2 How to Replace the Fuse



 WARNING
<p>Use the proper fuse.</p> <p>Use of a wrong fuse can result in fire and damage the equipment.</p>

The two fuses (Type: FGBO-A 250V 3A PBF, Code No.: 000-155-841-10) in the power cable assy. protect the system from reverse polarity of the power supply and equipment fault. If you cannot turn on the power, a fuse may have blown. Find the cause before replacing the fuse. If the fuse blows after replacement, contact your dealer for advice.

3.3 Battery Voltage Alert

A battery icon appears at the top of the display when the battery voltage is too high or too low.

Battery icon and meaning

Icon	Meaning
	Voltage is lower than 10 VDC. If the voltage goes below 9 V, the equipment is automatically turned off.
	Voltage is higher than 32 VDC. If the voltage goes higher than 33 V, the equipment is automatically turned off.

3.4 Troubleshooting

The table below provides basic troubleshooting procedures which the user may follow to restore normal operation.

Troubleshooting table

If...	then check...
The power does not turn on	<ul style="list-style-type: none"> • the power/data cable is securely connected and not damaged. If damaged, replace the cable. • the battery voltage is within its rated range. • the fuse. Replace with the specified fuse if necessary.
There is no response when the key is pressed	<ul style="list-style-type: none"> • Reboot the system. If there is still no response, contact your local dealer.
the screen is blank	<ul style="list-style-type: none"> • Press the [⏻/BRILL] key twice and adjust the brilliance setting.
no echo appears but the fixed range scale appears	<ul style="list-style-type: none"> • if the picture advance speed is set to [Stop] (see section 1.11). • if scroll-back mode is enabled (see section 1.16). • If the [External KP] is set to "On" (see page 2-9) and if the transmission of external sounder is set to "Off". • if the transducer plug is loosened. Fasten if necessary. • if the transducer cable is damaged. Replace if necessary.
echo appears but zero line does not	<ul style="list-style-type: none"> • if the range shifting is set to "0" (see section 1.10). • if the zero line rejection is "Off" (see page 7). • the draft setting; Should be other than "0".
sensitivity is low	<ul style="list-style-type: none"> • the gain setting. Adjust the gain higher (see section 1.7). • if air bubbles or marine life are clinging to the transducer face. • for dirty water or if the bottom is too soft to return an echo.
there is extreme interference or noise	<ul style="list-style-type: none"> • if the transducer is too close to the engine. Contact your local dealer for advice. • if the unit is properly grounded. Replace if necessary. • if other echo sounders of the same frequency as own are being operated nearby.
the depth indication is not shown	<ul style="list-style-type: none"> • the range (see section 1.6). Set the range so that the seabed echoes appear on the screen. • If the depth indication setting is set to [On] (see page 1-48). • the [Bottom Level XDR]. Adjust the [Bottom Level XDR] (see page 2-8).
the speed/water temperature readout is unrealistic or not present	<ul style="list-style-type: none"> • if the sensor plug is securely connected and not damaged. Change if necessary. • if the sensor is not damaged.
the position readout is unrealistic or not present	<ul style="list-style-type: none"> • the connection between fish finder and navigator. • if the navigator is not damaged.
NMEA2000 data is not received	<ul style="list-style-type: none"> • Turn on the power of NMEA2000 network. If the unit has already been turned on, reboot the system.

3.5 Diagnostics

If you feel your unit is not working properly, conduct the diagnostic test to find the probable cause. If you cannot restore normal operation, contact your dealer for advice.

1. Press the **MENU/ESC** key to open the menu.
2. Select [Service], then press the **KNOB**.

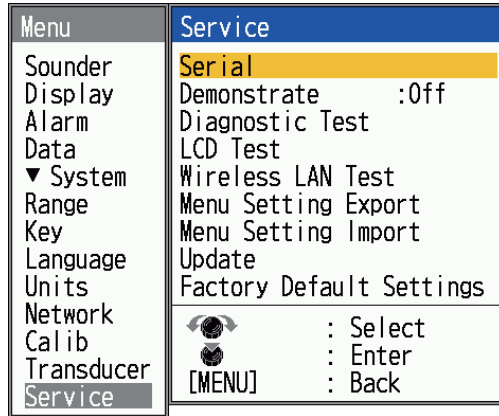

3. Select [Diagnostic Test], then press the **KNOB**.
The test result will be displayed as shown below. If "NG" is displayed, please contact FURUNO or your local dealer for repair.

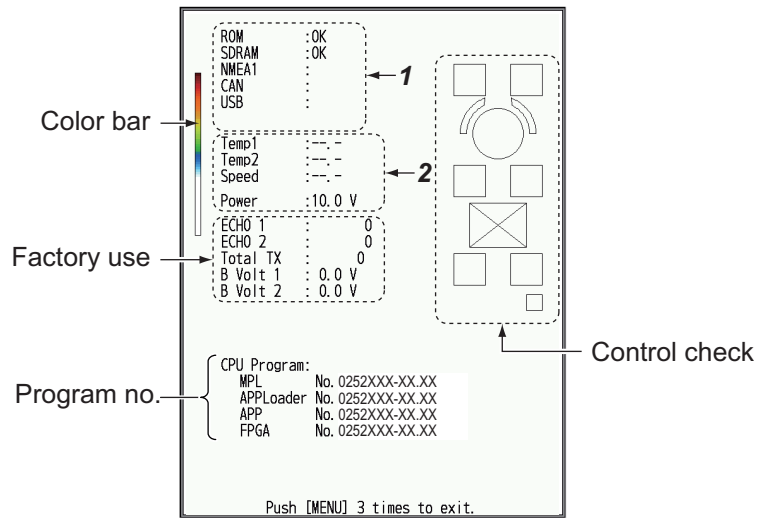

Prog.	FCV-600	FCV-800
MPL	0252483-XX.XX	0252487-XX.XX
APPLoader	0252484-XX.XX	0252488-XX.XX
APP	0252485-XX.XX	0252489-XX.XX
FPGA	0252486-XX.XX	0252486-XX.XX

XX.XX=version no.

No.	Test item	Content
1	ROM	"OK" is shown if check is normal; "NG" for error.
	SDRAM	
	NMEA1*2	Reserved for factory use. Special connector required. Nothing appears unless the connector is used.
	CAN	"OK" is shown if check is normal; "NG" for error.
	USB	Export the menu setting values to a USB flash memory. "OK" is shown if the USB is inserted correctly, "---" is shown for error.
2	Water temp.*1/ Water temp.1*2	Water temp. and speed from the respective sensors. Updated every three seconds. Displayed as "--.-" for error.
	Water temp.2*2	
	Speed	
	Power	Voltage of power source. Updated every three seconds. Displayed as "--.-" for error.

*1: For FCV-600 *2: For FCV-800

4. Check the keys and the **KNOB**.
 - 1) Press the key or the **KNOB**.
Each time a key or knob is pressed a tone sounds and the knob's corresponding on-screen circle "lights" in red if the knob is normal.
 - 2) Rotate the **KNOB**.
The knob's corresponding on-screen circle "lights" in red if the knob is normal.
5. To quit the test, press the **MENU/ESC** key three times to close the test menu.
6. Press the **MENU/ESC** key twice to close the window.

3.6 LCD Test

The LCD test checks the LCD for proper display of colors.

Note: To review the seven-tone screen easily, set the brilliance to maximum before starting the test.

1. Press the **MENU/ESC** key to open the menu.
2. Select [Service], then press the **KNOB**.
3. Select [LCD Test], then press the **KNOB**.
4. Press any key except **MENU/ESC** key to start the test. Press any key other than the **MENU/ESC** key to change the test color, in the sequence shown below. After the checkered pattern, the [Service] menu appears.

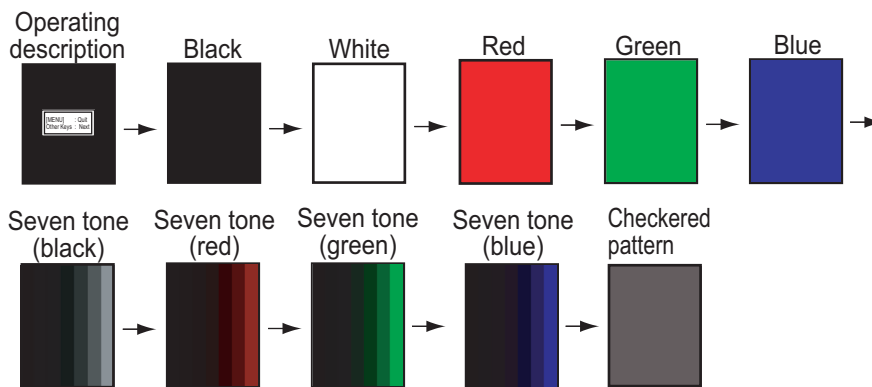

Note: If you want to stop in the middle of the test, press the **MENU/ESC** key.

5. Press the **MENU/ESC** key twice to close the window.

3.7 Wireless LAN Test

The wireless LAN test checks the unit's wireless module.

1. Press the **MENU/ESC** key to open the menu.
2. Select [Service], then press the **KNOB**.

3. Select [Wireless LAN Test], then press the **KNOB**.
The test result will be displayed.

```
Wireless LAN Test
Wireless LAN Signal Strength:-37dBm
Physical Address      :
54-F8-2A-02-3B-20
IPv4 Address         :
172.31.0.100
Wireless LAN Name    :Router
Mode                 :AP Mode
Working Status       :Network Up
Wireless LAN Version :
X.X.X-XXX
⌂ : Refresh
[MENU] : Quit
```

Note: Press the **KNOB** to refresh the latest information.

4. Press the **MENU/ESC** key twice to close the window.

3.8 Restore Factory Default Settings

You can restore default menu settings (except language) as follows.

1. Press the **MENU/ESC** key to open the menu.
2. Select [Service], then press the **KNOB**.
3. Select [Factory Default Settings], then press the **KNOB**.
4. Select [Yes], then press the **KNOB**.
The unit beeps, the startup screen appears, then the [Installation] menu appears.

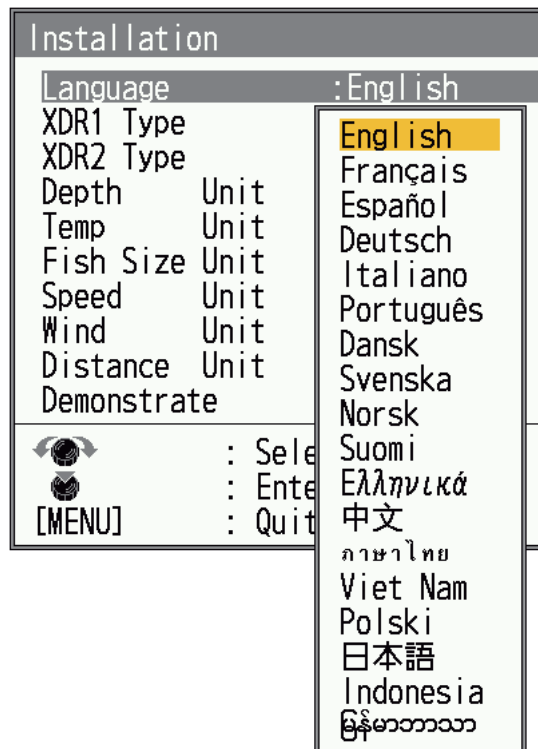

5. Select the appropriate language, then press the **MENU/ESC** key twice.
The transducer settings will also return to the factory defaults, make sure to set the transducer settings (see section 2.8).

APPX. 1 MENU TREE

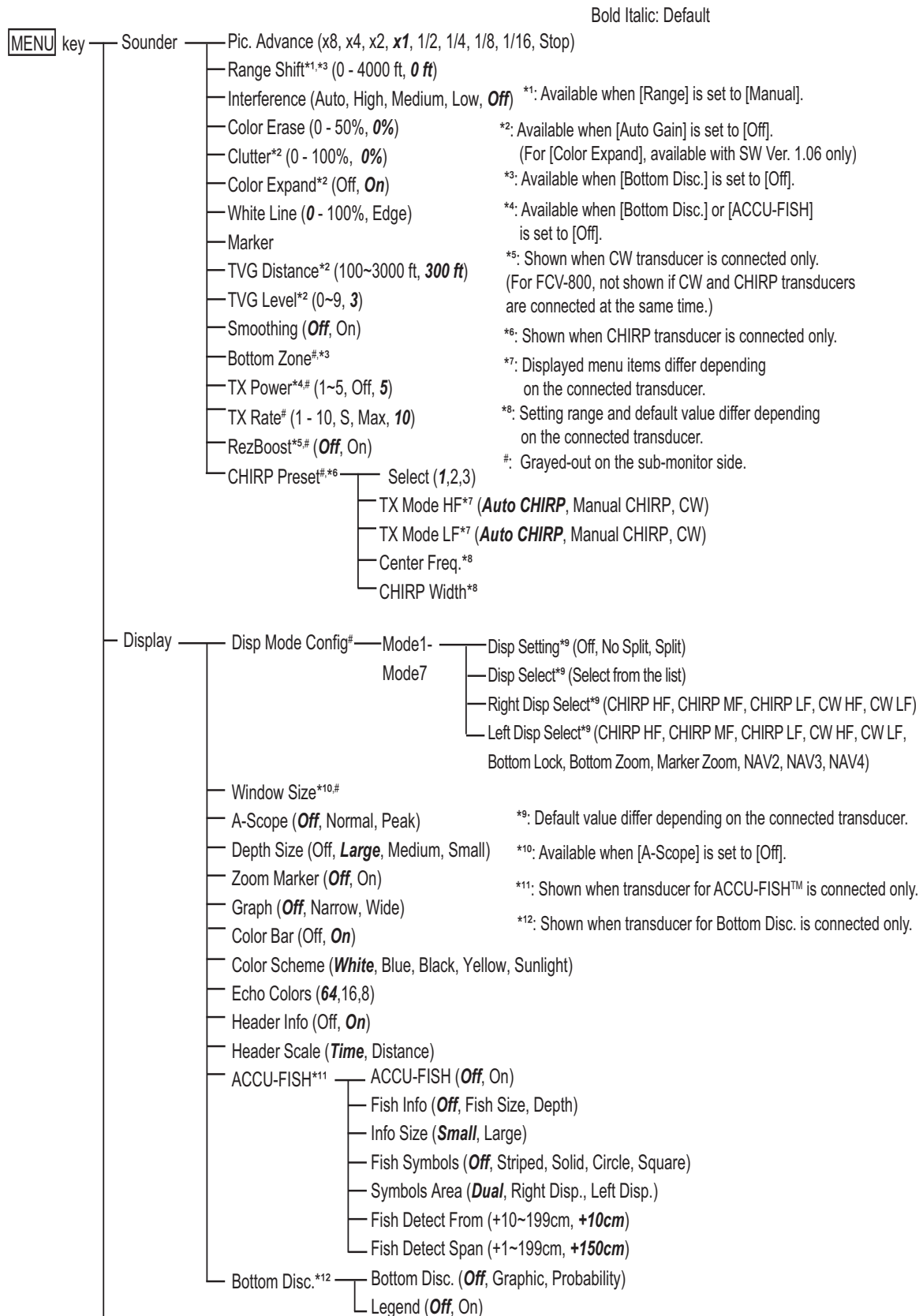

APPX. 1 MENU TREE

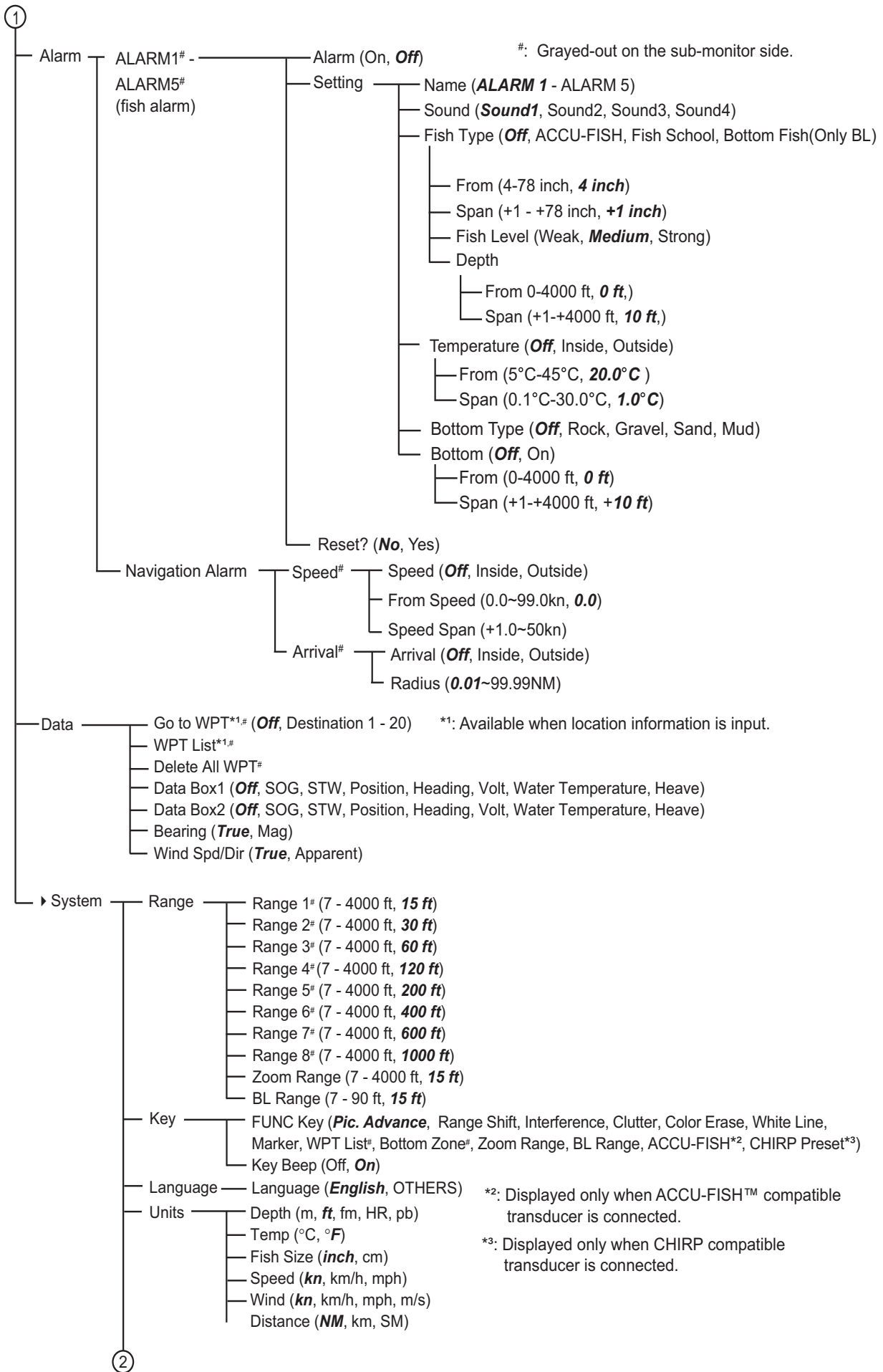

2

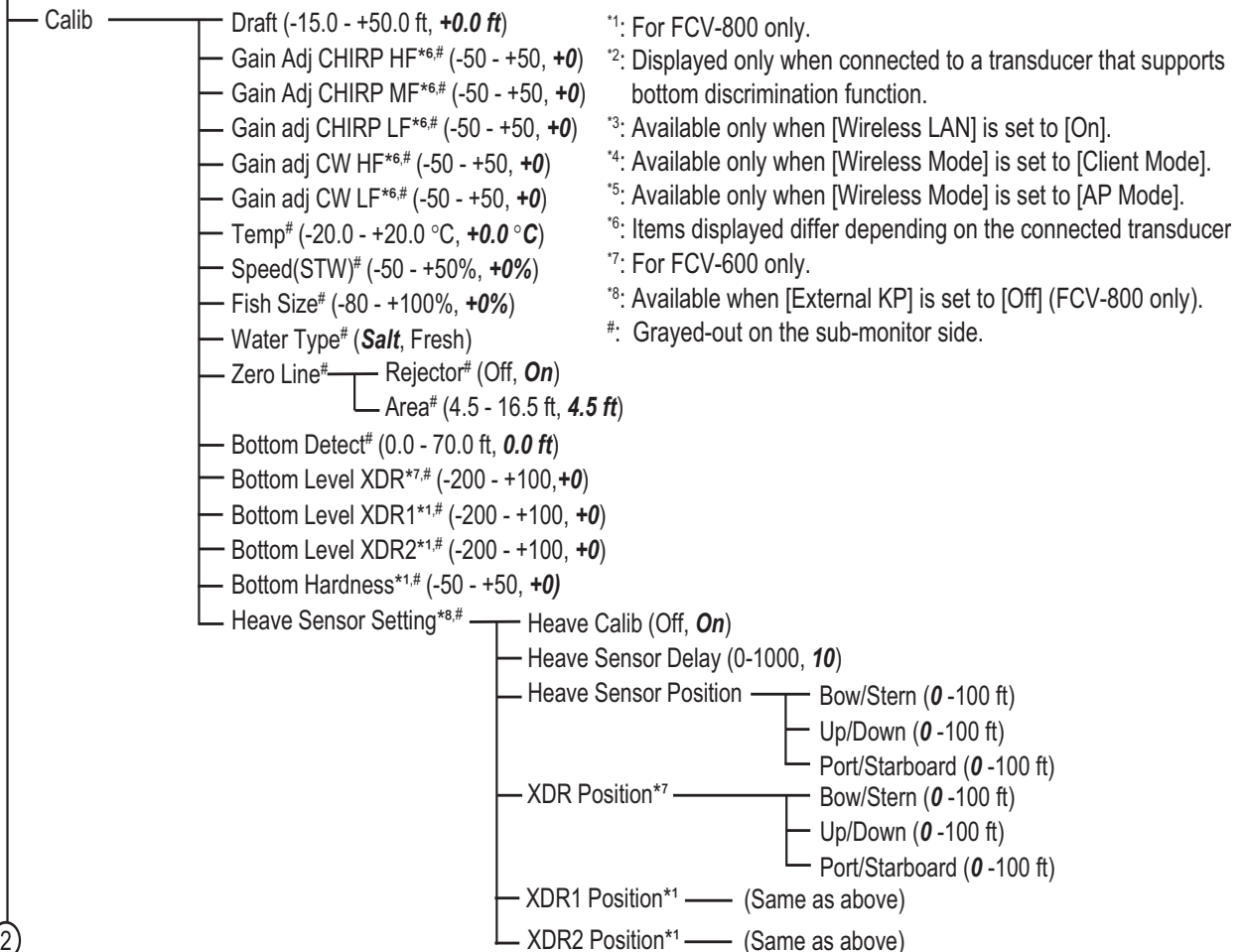
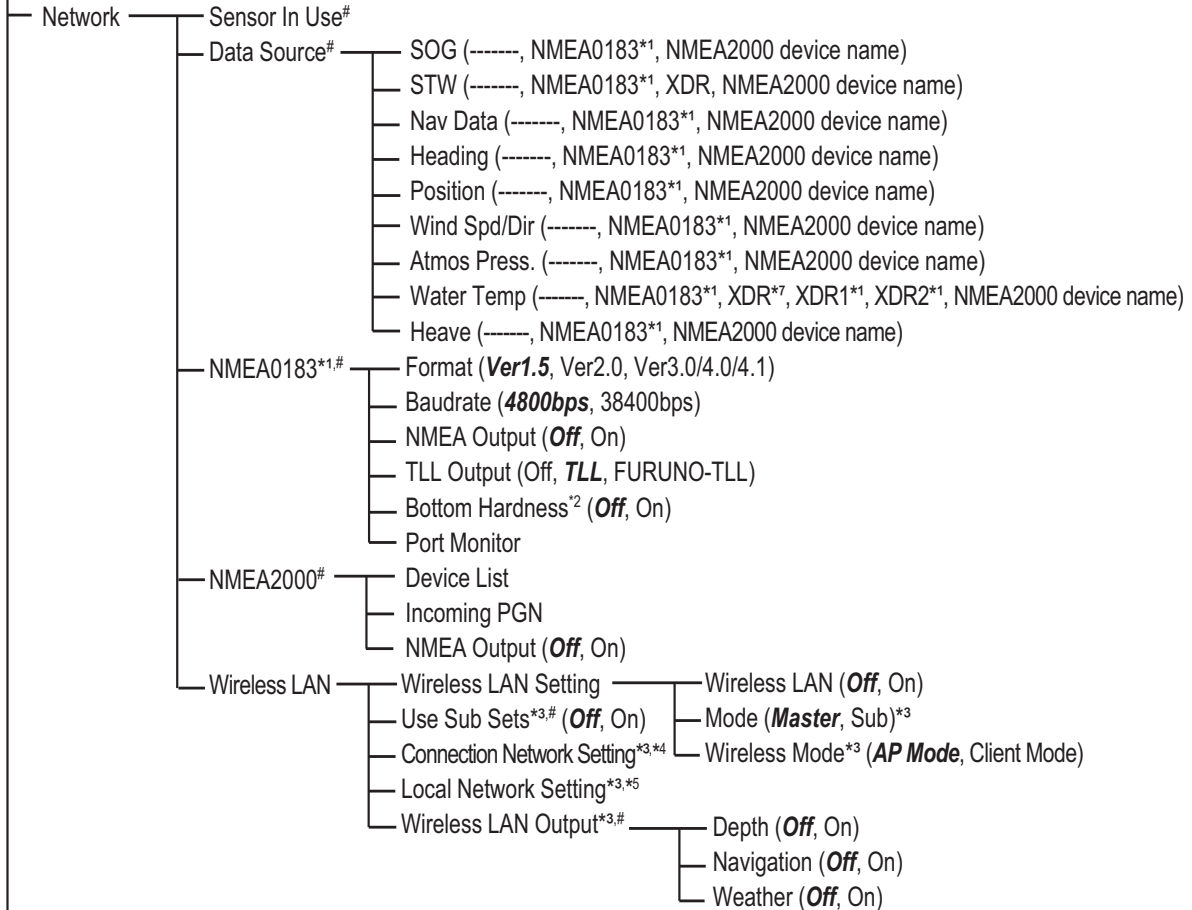

*1: For FCV-800 only.
 *2: Displayed only when connected to a transducer that supports bottom discrimination function.
 *3: Available only when [Wireless LAN] is set to [On].
 *4: Available only when [Wireless Mode] is set to [Client Mode].
 *5: Available only when [Wireless Mode] is set to [AP Mode].
 *6: Items displayed differ depending on the connected transducer
 *7: For FCV-600 only.
 *8: Available when [External KP] is set to [Off] (FCV-800 only).
 #: Grayed-out on the sub-monitor side.

2

APPX. 1 MENU TREE

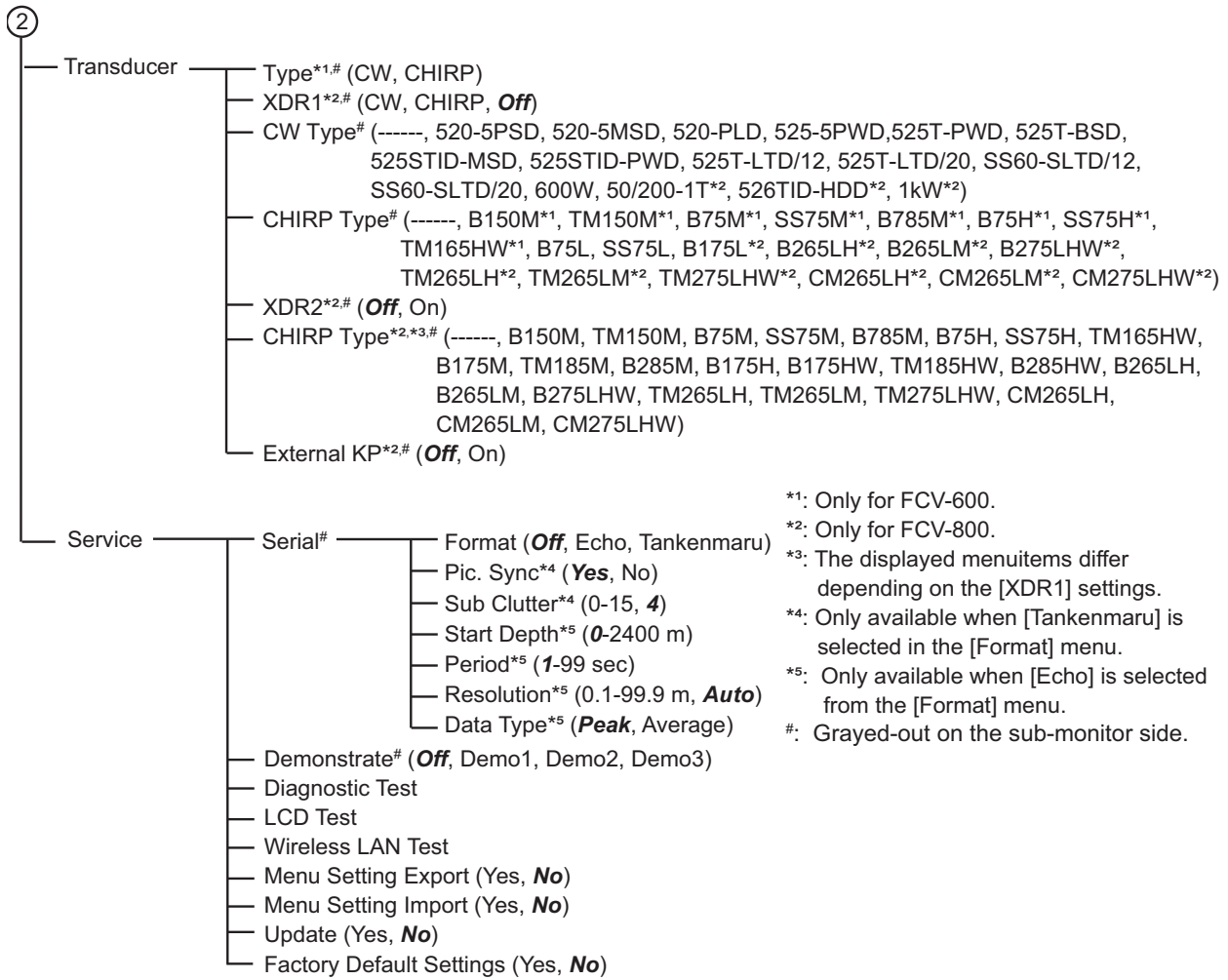

*1: Only for FCV-600.

*2: Only for FCV-800.

*3: The displayed menuitems differ depending on the [XDR1] settings.

*4: Only available when [Tankenmaru] is selected in the [Format] menu.

*5: Only available when [Echo] is selected from the [Format] menu.

#: Grayed-out on the sub-monitor side.

APPX. 2 TRANSDUCER LIST

The following table shows transducer compatibility with the ACCU-FISH™, Bottom Discrimination, RezBoost™, and hardness functions (supported: ✓ unsupported: ×).

CW Transducers

Transducer	ACCU-FISH™	Bottom Discrimination	RezBoost™	Hardness	Remarks
520-5PSD	✓	✓	✓	✓	600W For FCV-600/800
520-5MSD	✓	✓	✓	✓	
520-PLD	✓	✓	✓	✓	
525-5PWD	✓	✓	✓	✓	
525STID-PWD	✓	✓	✓	✓	
525STID-MSD	✓	✓	✓	✓	
525T-PWD	✓	✓	✓	✓	
525T-BSD	✓	✓	✓	✓	
525T-LTD/12	✓	✓	✓	✓	
525T-LTD/20	✓	✓	✓	✓	
SS60-SLTD/12	✓	✓	✓	✓	
SS60-SLTD/20	✓	✓	✓	✓	
200B-5S	×	×	×	✓	
50B-6	×	×	×	✓	
50B-6B	×	×	×	✓	
50/200-1T	✓	✓	✓	✓	
526TID-HDD	✓	✓	✓	✓	

Single Frequency CHIRP Transducers

Transducer	ACCU-FISH™	Bottom Discrimination	RezBoost™	Hardness	Remarks
TM150M	×	×	×	×	300W For FCV-600/800
B-75L	×	×	×	×	
B-75H	×	×	×	×	600W FCV-600/800
B-175L	×	×	×	×	1kW For FCV-800
B-175H	×	×	×	×	

Dual Frequency CHIRP Transducers

Transducer	ACCU-FISH™	Bottom Discrimination	RezBoost™	Hardness	Remarks
B265LH-FJ12	✓	×	×	×	1kW For FCV-800
TM265LH-FJ12	✓	×	×	×	
CM265LH-FJ12	✓	×	×	×	

Other compatible transducers

Single Frequency CHIRP Transducers

Transducer	ACCU-FISH™	Bottom Discrimination	RezBoost™	Hardness	Remarks
B150M	×	×	×	×	300W
SS75L	×	×	×	×	
P95M	×	×	×	×	
P75M	×	×	×	×	600W
B75HW	×	×	×	×	
B75M	×	×	×	×	
SS75M	×	×	×	×	
B785M	×	×	×	×	
SS75H	×	×	×	×	
TM165HW	×	×	×	×	
B175M	×	×	×	×	
TM185M	×	×	×	×	
B285M	×	×	×	×	
B175HW	×	×	×	×	
TM185HW	×	×	×	×	
B285HW	×	×	×	×	

Dual Frequency CHIRP Transducers (FCV-800 only)

Transducer	ACCU-FISH™	Bottom Discrimination	RezBoost™	Hardness	Remarks
B765LM	×	×	×	×	300W/600W
B765LH	×	×	×	×	
B265LM	×	×	×	×	1kW
TM265LM	×	×	×	×	
CM265LM	×	×	×	×	
B275LHW	×	×	×	×	
TM275LHW	×	×	×	×	
CM275LHW	×	×	×	×	

APPX. 3 RADIO REGULATORY INFORMATION

Wireless Interoperability

This product is designed to be interoperable with any wireless LAN product that is based on direct sequence spread spectrum (DSSS) and orthogonal frequency division multiplexing (OFDM) radio technology and to comply with the following standards.

- IEEE Std 802.11b Standard on 2.4 GHz Wireless LAN
- IEEE Std 802.11g Standard on 2.4 GHz Wireless LAN
- IEEE Std 802.11n Standard on 2.4 GHz Wireless LAN

Safety

This product, like other radio devices, emits radio frequency electromagnetic energy. The level of energy emitted by this device, however, is less than the electromagnetic energy emitted by other wireless devices such as mobile phones. This product operates within the guidelines found in radio frequency safety standards and recommendations. These standards and recommendations reflect the consensus of the scientific community and result from deliberations of panels and committees of scientists who continually review and interpret the extensive research literature. In some situations or environments, the use of this product may be restricted by the proprietor of the building or responsible representatives of the applicable organization. Examples of such situations include the following:

- Using this product onboard airplanes, or
- Using this product in any other environment where the risk of interference with other devices or services is perceived or identified as being harmful.

If uncertain of the policy that applies to the use of wireless devices in a specific organization or environment (an airplane, for example), ask for authorization to use this product before turning it on.

Export Regulation

Radio wave certification is necessary at the export destination. The Wireless LAN of this product operates in the 2.4 GHz band, which does not require a license in most countries. However, the conditions for use of the wireless LAN depend on the country or the area.

USA-Federal Communications Commission (FCC)

This device complies with part 15 of the FCC Rules. Operation is subject to the following two conditions:

- (1) This device may not cause harmful interference, and
- (2) This device must accept any interference received, including interference that may cause undesired operation. Any changes or modifications not expressly approved by the party responsible for compliance could void the user's authority to operate the equipment.

Caution: Exposure to Radio Frequency Radiation

- This equipment complies with FCC radiation exposure limits set forth for an uncontrolled environment and meets the FCC radio frequency (RF) Exposure Guidelines in Supplement C to OET65.
- This equipment should be installed and operated keeping the radiator at least 20 cm or more away from person's body.
- This device must not be co-located or operating in conjunction with any other antenna or transmitter.

Innovation, Science and Economic Development Canada (ISED)

This device contains licence-exempt transmitter(s)/receiver(s) that comply with Innovation, Science and Economic Development Canada's licence-exempt RSS(s). Operation is subject to the following two conditions:

- (1) This device may not cause interference.
- (2) This device must accept any interference, including interference that may cause undesired operation of the device.

Cet appareil contient un ou plusieurs émetteurs / récepteurs exempts de licence qui sont conformes à la norme « exempts de licence RSS (s) » Canadienne d'Innovation, Sciences et Développement économique. L'exploitation est autorisée aux deux conditions suivantes:

- (1) l'appareil ne doit pas produire de brouillage.
- (2) l'utilisateur de l'appareil doit accepter tout brouillage radioélectrique subi, même si le brouillage est susceptible d'en compromettre le fonctionnement.

Caution: Exposure to Radio Frequency Radiation

This equipment complies with ISED radiation exposure limits set forth for an uncontrolled environment and meets RSS-102 of the ISED radio frequency (RF) Exposure rules. This equipment should be installed and operated keeping the radiator at least 20 cm or more away from person's body.

Cet équipement est conforme aux limites d'exposition aux rayonnements énoncées pour un environnement non contrôlé et respecte les règles d'exposition aux fréquences radioélectriques (RF) CNR-102 de l'ISED. Cet équipement doit être installé et utilisé en gardant une distance de 20 cm ou plus entre le dispositif rayonnant et le corps.

To reduce potential radio interference to other users, the antenna type and its gain should be so chosen that the equivalent isotropically radiated power (EIRP) is not more than that required for successful communication.

**SPECIFICATIONS OF FISH FINDER
FCV-600**

1 GENERAL

- 1.1 TX frequency/method
50 kHz and 200 kHz single or dual frequency transmitting or CHIRP: LF/MF/HF (40 to 225 kHz)
- 1.2 Output power
300/600 W
- 1.3 TX rate
Max. 3,000 pulse/min
- 1.4 Pulse length
0.04 to 3.0 ms

2 FISH FINDER

- 2.1 Screen size
5.7-inch color LCD, 640 x 480 (VGA)
- 2.2 Brilliance
1,000 cd/m² typical
- 2.3 Display mode
Single frequency, Dual frequency, Zoom (high or low freq.), Nav data, A-scope
- 2.4 Expansion mode
Bottom lock, Bottom zoom, Marker zoom, Full screen
- 2.5 Basic range
7 to 4,000 ft
- 2.6 Shift
0 to 4,000 ft
- 2.7 Zoom range
7 to 4,000 ft
- 2.8 Display color
Echo color: 8/16/64 colors according to echo intensity
Palette: select from five colors
- 2.9 Picture advance speed
9 steps (Lines/TX: x8, x4, x2, x1, 1/2, 1/4, 1/8, 1/16 or stop)
- 2.10 Function settings
CHIRP, Heave adjustment, Estimation for bottom composition, ACCU-FISH™, RezBoost™

3 INTERFACE

- 3.1 Number of ports
 - Serial
1 port, 38,400 bps (only for research purpose)
 - Wireless LAN
IEEE802.11b/g/n, 2.412 to 2.462 GHz, 0.0363 W
 - NMEA2000
1 port, LEN: 1
 - USB
1 port, USB2.0, for maintenance
- 3.2 Data sentences (wireless LAN)
 - Input/Output
DPT, GGA, HDG, HDT, MDA, MTW, MWV, RMB, TLL, VHW, VTG, ZDA
- 3.3 Output P sentences
 - PFEC
GPhve
- 3.4 NMEA2000 PGN
 - Input
059392/904, 060160/416/928, 061184, 065240/280, 126208/720/996, 127250/252/257, 128259, 129025/026/029/283/284, 130306/310/311/312/314/316/577/821
 - Output
059392/904, 060928, 061184, 126208/464/720/993/996/998, 128259/267, 130310/312/316/821/822/830/831/832

4 POWER SUPPLY

12-24 VDC: 1.0-0.6 A

5 ENVIRONMENTAL CONDITIONS

- 4.1 Ambient temperature -15°C to +55°C
- 4.2 Relative humidity 93% at 40°C
- 4.3 Waterproofing IP56
- 4.4 Vibration IEC 60945 Ed.4

6 UNIT COLOR

N1.0

**SPECIFICATIONS OF FISH FINDER
FCV-800**

1 GENERAL

- 1.1 TX frequency/method 50 kHz or 200 kHz dual frequency transmitting or CHIRP: LF/MF/HF (40 to 225 kHz) dual transmitting simultaneously
- 1.2 Output power 300 W/ 600 W/ 1 kW
- 1.3 TX rate Max. 3,000 pulse/min
- 1.4 Pulse length 0.04 to 3.0 ms

2 FISH FINDER

- 2.1 Screen size 8.4-inch color LCD, 800 x 600 (SVGA)
- 2.2 Brilliance 800 cd/m² typical
- 2.3 Display mode Single frequency, Dual frequency, Zoom (high or low freq.), Nav data, A-scope
- 2.4 Expansion mode Bottom lock, Bottom zoom, Marker zoom, Full screen
- 2.5 Basic range 7 to 4,000 ft
- 2.6 Shift 0 to 4,000 ft
- 2.7 Zoom range 7 to 4,000 ft
- 2.8 Display color Echo color: 8/16/64 colors according to echo intensity
Palette: select from five colors
- 2.9 Picture advance speed 9 steps (Lines/TX: x8, x4, x2, x1, 1/2, 1/4, 1/8, 1/16 or stop)
- 2.10 Function settings CHIRP, Heave adjustment, Estimation for bottom composition, Bottom hardness, ACCU-FISH™, RezBoost™

3 INTERFACE

- 3.1 Number of ports
 - Serial 2 ports,
Port 1: NMEA0183 V1.5/2.0/3.0/4.0/4.1, 4,800/38,400 bps
Port 2: 38,400 bps (only for research purpose)
 - Wireless LAN IEEE802.11b/g/n, 2.412 to 2.462 GHz, 0.0363 W
 - NMEA2000 1 port, LEN: 1
 - USB 1 port, USB2.0, for maintenance
 - External KP 1 port
- 3.2 Data sentences NMEA0183
 - Input BWC, GGA, GLL, GNS, HDG, HDT, MDA, MTW, MWV, RMA, RMB, RMC, THS, VHW, VTG, XTE, ZDA
 - Output DBS, DBT, DPT, MTW, RMB, TLL, VHW
- 3.3 Output P sentences NMEA0183
 - PFEC SDbhr, SDmrk, pidat, SDtbd, SDtfl
- 3.4 Data sentences (wireless LAN)
 - Input/Output DPT, GGA, HDG, HDT, MDA, MTW, MWV, RMB, TLL, VHW, VTG, ZDA
- 3.5 Output P sentences (wireless LAN)
 - PFEC GPhve
- 3.6 NMEA2000 PGN
 - Input 059392/904, 060160/416/928, 061184, 065240/280, 126208/720/996, 127250/252/257, 128259, 129025/026/029/283/284, 130306/310/311/312/314/316/577/821

Output 059392/904, 060928, 061184, 126208/464/720/993/996/998,
128259/267, 130310/312/316/821/822/830/831/832

4 POWER SUPPLY

12-24 VDC: 1.6-0.8 A

5 ENVIRONMENTAL CONDITIONS

- 4.1 Ambient temperature -15°C to +55°C
- 4.2 Relative humidity 93% at 40°C
- 4.3 Waterproofing IP56
- 4.4 Vibration IEC 60945 Ed.4

6 UNIT COLOR

N1.0

INDEX

A

- ACCU-FISH alarm..... 1-30
- ACCU-FISH setup..... 1-23, 1-24
- Arrival alarm..... 1-33
- A-scope display..... 1-21

B

- Battery voltage alert..... 3-2
- Bottom discrimination display..... 1-25
- Bottom fish alarm..... 1-30
- Bottom lock display..... 1-7
- Bottom type alarm..... 1-31
- Bottom zone..... 1-46
- Bottom zoom display..... 1-8
- BRILL key..... 1-2
- Brilliance..... 1-2

C

- Calib menu..... 2-7
- Cleaning..... 3-1
- Clutter..... 1-20
- Color erase..... 1-20
- Controls..... 1-1

D

- Data menu..... 1-50
- Default settings..... 3-8
- Depth indication size..... 1-48
- Depth measurement..... 1-14
- Diagnostic test..... 3-4
- Display menu..... 1-48
- Dual frequency display..... 1-6

F

- Fish alarm..... 1-30
- FUNC key..... 1-33
- Fuse replacement..... 3-2

G

- Gain adjustment..... 1-13
- GAIN knob..... 1-13

H

- Header info..... 1-49
- Header scale..... 1-49

I

- Interference..... 1-19

K

- Key menu..... 2-2

L

- Language menu..... 2-2
- LCD test..... 3-6

M

- Maintenance..... 3-1
- Marker zoom display..... 1-8

N

- Nav data display..... 1-38

P

- Palette..... 1-49
- Picture advance speed..... 1-18

R

- Range..... 1-12
- RANGE key..... 1-12
- Range menu..... 2-1
- Range shift..... 1-16
- RezBoost..... 1-27

S

- Shifting range..... 1-17
- Smoothing..... 1-46
- Sounder menu..... 1-45
- Speed alarm..... 1-32
- System configuration..... ix
- System menu..... 2-1

T

- Transducer menu..... 2-9
- Troubleshooting..... 3-3
- TX power..... 1-47
- TX rate..... 1-47

U

- Units menu..... 2-2

V

- VRM..... 1-14

W

- Water temperature alarm..... 1-31
- Water temperature graph..... 1-49
- Waypoints..... 1-36, 1-37, 1-38
- Wind speed and direction source..... 1-50
- Window size..... 1-48

Z

- Zoom marker..... 1-48

Declaration of Conformity

[FCV-600/FCV-800]

Bulgarian (BG)	С настоящото Furuno Electric Co., Ltd. декларира, че гореспоменат тип радиосъоръжение е в съответствие с Директива 2014/53/ЕС, СИ 2017/1206. Цялостният текст на ЕС/УК декларацията за съответствие може да се намери на следния интернет адрес:
Spanish (ES)	Por la presente, Furuno Electric Co., Ltd. declara que el tipo de equipo radioeléctrico arriba mencionado es conforme con la Directiva 2014/53/UE, SI 2017/1206. El texto completo de la declaración de conformidad de la EU/UK está disponible en la siguiente dirección Internet:
Czech (CS)	Tímto Furuno Electric Co., Ltd. prohlašuje, že výše zmíněné typ rádiového zařízení je v souladu se směrnicí 2014/53/EU, SI 2017/1206. Úplné znění EU/SK prohlášení o shodě je k dispozici na této internetové adrese:
Danish (DA)	Hermed erklærer Furuno Electric Co., Ltd., at ovennævnte radioudstyr er i overensstemmelse med direktiv 2014/53/EU, SI 2017/1206. EU/UK-overensstemmelseserklæringens fulde tekst kan findes på følgende internetadresse:
German (DE)	Hiermit erkläre die Furuno Electric Co., Ltd., dass der oben genannte Funkanlagentyp der Richtlinie 2014/53/EU, SI 2017/1206 entspricht. Der vollständige Text der EU/UK-Konformitätserklärung ist unter der folgenden Internetadresse verfügbar:
Estonian (ET)	Käesolevaga deklareerib Furuno Electric Co., Ltd., et ülalmainitud raadioseadme tüüp vastab direktiivi 2014/53/EL, SI 2017/1206 nõuetele. EL/GB vastavusdeklaratsiooni täielik tekst on kättesaadav järgmisel internetiaadressil:
Greek (EL)	Με την παρούσα η Furuno Electric Co., Ltd., δηλώνει ότι ο προαναφερθέντας ραδιοεξοπλισμός πληροί την οδηγία 2014/53/ΕΕ, SI 2017/1206. Το πλήρες κείμενο της δήλωσης συμμόρφωσης ΕΕ/UK διατίθεται στην ακόλουθη ιστοσελίδα στο διαδίκτυο:
English (EN)	Hereby, Furuno Electric Co., Ltd. declares that the above-mentioned radio equipment type is in compliance with Directive 2014/53/EU, SI 2017/1206. The full text of the EU/UK declaration of conformity is available at the following internet address:
French (FR)	Le soussigné, Furuno Electric Co., Ltd., déclare que l'équipement radioélectrique du type mentionné ci-dessus est conforme à la directive 2014/53/UE, SI 2017/1206. Le texte complet de la déclaration UE/RU de conformité est disponible à l'adresse internet suivante:
Croatian (HR)	Furuno Electric Co., Ltd. ovime izjavljuje da je gore rečeno radijska oprema tipa u skladu s Direktivom 2014/53/EU, SI 2017/1206. Cjeloviti tekst EU/UK izjave o sukladnosti dostupan je na sljedećoj internetskoj adresi:
Italian (IT)	Il fabbricante, Furuno Electric Co., Ltd., dichiara che il tipo di apparecchiatura radio menzionato sopra è conforme alla direttiva 2014/53/UE, SI 2017/1206. Il testo completo della dichiarazione di conformità UE/RU è disponibile al seguente indirizzo Internet:
Latvian (LV)	Ar šo Furuno Electric Co., Ltd. deklarē, ka augstāk minēts radioiekārta atbilst Direktīvai 2014/53/ES, SI 2017/1206. Pilns ES/AK atbilstības deklarācijas teksts ir pieejams šādā interneta vietnē:

- Lithuanian (LT) Aš, Furuno Electric Co., Ltd., patvirtinu, kad pirmiau minėta radijo įrenginių tipas atitinka Direktyvą 2014/53/ES, SI 2017/1206.
Visas ES/JK atitikties deklaracijos tekstas prieinamas šiuo interneto adresu:
- Hungarian (HU) Furuno Electric Co., Ltd. igazolja, hogy fent említett típusú rádióberendezés megfelel a 2014/53/EU, SI 2017/1206 irányelvnek.
Az EU/EK-megfelelőségi nyilatkozat teljes szövege elérhető a következő internetes címen:
- Maltese (MT) B'dan, Furuno Electric Co., Ltd., niddikjara li msemmija hawn fuq-tip ta' tagħmir tar-radju huwa konformi mad-Direttiva 2014/53/UE, SI 2017/1206.
It-test kollu tad-dikjarazzjoni ta' konformità tal-UE/RU huwa disponibbli f'dan l-indirizz tal-Internet li ġej:
- Dutch (NL) Hierbij verklaar ik, Furuno Electric Co., Ltd., dat het hierboven genoemde type radioapparaat conform is met Richtlijn 2014/53/EU, SI 2017/1206.
De volledige tekst van de EU/VK-conformiteitsverklaring kan worden geraadpleegd op het volgende internetadres:
- Polish (PL) Furuno Electric Co., Ltd. niniejszym oświadczam, że wyżej wymieniony typ urządzenia radiowego jest zgodny z dyrektywą 2014/53/UE, SI 2017/1206.
Pełny tekst deklaracji zgodności UE/UK jest dostępny pod następującym adresem internetowym:
- Portuguese (PT) O(a) abaixo assinado(a) Furuno Electric Co., Ltd. declara que o mencionado acima tipo de equipamento de rádio está em conformidade com a Diretiva 2014/53/UE, SI 2017/1206.
O texto integral da declaração de conformidade da EU/UK está disponível no seguinte endereço de Internet:
- Romanian (RO) Prin prezenta, Furuno Electric Co., Ltd. declară că echipamentul radio menționat mai sus este în conformitate cu Directiva 2014/53/UE, SI 2017/1206.
Textul integral al declarației de conformitate UE/RU este disponibil la următoarea adresă internet:
- Slovak (SK) Furuno Electric Co., Ltd. týmto vyhlasuje, že vyššie spomínané rádiové zariadenie typu je v súlade so smernicou 2014/53/EÚ, SI 2017/1206.
Úplné EÚ/SK vyhlásenie o zhode je k dispozícii na tejto internetovej adrese:
- Slovenian (SL) Furuno Electric Co., Ltd. potrjuje, da je zgoraj omenjeno tip radijske opreme skladen z Direktivo 2014/53/EU, SI 2017/1206.
Celotno besedilo izjave EU/ZK o skladnosti je na voljo na naslednjem spletnem naslovu:
- Finnish (FI) Furuno Electric Co., Ltd. vakuuttaa, että yllä mainittu radiolaitetyyppi on direktiivin 2014/53/EU, SI 2017/1206 mukainen.
EU/UK-vaatimustenmukaisuusvakuutuksen täysimittainen teksti on saatavilla seuraavassa internetosoitteessa:
- Swedish (SV) Härmed försäkrar Furuno Electric Co., Ltd. att ovan nämnda typ av radioutrustning överensstämmer med direktiv 2014/53/EU, SI 2017/1206.
Den fullständiga texten till EU/Storbritanniens försäkran om överensstämmelse finns på följande webbadress:

Online Resource

http://www.furuno.com/en/support/red_doc

Notice for radiated immunity

The test for the radiated immunity is performed up to 2.7 GHz only without the special condition of spot frequency being applied. There is a chance that this equipment may interfere with allocated services in the frequency range of 2.7 GHz to 6 GHz, particularly in harbors, rivers, lake banks, etc.