

FURUNO

FA-30 AIS RECEIVER



OPERATOR'S MANUAL



FURUNO ELECTRIC CO., LTD.

www.furuno.com



ECF

(Elemental Chlorine Free)

The paper used in this manual
is elemental chlorine free.

FURUNO ELECTRIC CO., LTD.

9-52, Ashihara-cho,
Nishinomiya, 662-8580, JAPAN

•FURUNO Authorized Distributor/Dealer

All rights reserved.

Printed in Japan

A : MAY. 2007
E : OCT. 31, 2012

Pub. No. OME-44430-E

(REFU) FA-30



* 00016497014 *

IMPORTANT NOTICES

General

- This manual has been authored with simplified grammar, to meet the needs of international users.
- The operator of this equipment must read and follow the descriptions in this manual. Wrong operation or maintenance can cancel the warranty or cause injury.
- Do not copy any part of this manual without written permission from FURUNO.
- If this manual is lost or worn, contact your dealer about replacement.
- The contents of this manual and equipment specifications can change without notice.
- The example screens (or illustrations) shown in this manual can be different from the screens you see on your display. The screens you see depend on your system configuration and equipment settings.
- Save this manual for future reference.
- Any modification of the equipment (including software) by persons not authorized by FURUNO will cancel the warranty.
- All brand and product names are trademarks, registered trademarks or service marks of their respective holders.

How to discard this product

Discard this product according to local regulations for the disposal of industrial waste. For disposal in the USA, see the homepage of the Electronics Industries Alliance (<http://www.eiae.org/>) for the correct method of disposal.

How to discard a used battery

Some FURUNO products have a battery(ies). To see if your product has a battery, see the chapter on Maintenance. Follow the instructions below if a battery is used. Tape the + and - terminals of battery before disposal to prevent fire, heat generation caused by short circuit.

In the European Union

The crossed-out trash can symbol indicates that all types of batteries must not be discarded in standard trash, or at a trash site. Take the used batteries to a battery collection site according to your national legislation and the Batteries Directive 2006/66/EU.

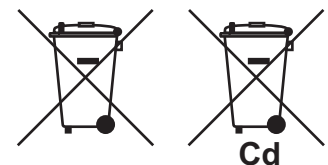

In the USA

The Mobius loop symbol (three chasing arrows) indicates that Ni-Cd and lead-acid rechargeable batteries must be recycled. Take the used batteries to a battery collection site according to local laws.

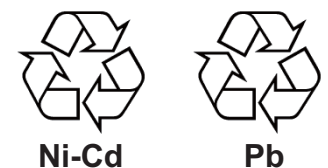



In the other countries



There are no international standards for the battery recycle symbol. The number of symbols can increase when the other countries make their own recycle symbols in the future.









SAFETY INSTRUCTIONS



The operator and installer must read the applicable safety instructions before attempting to install or operate the equipment.

 WARNING	Indicates a potentially hazardous situation which, if not avoided, could result in death or serious injury.
 CAUTION	Indicates a potentially hazardous situation which, if not avoided, can result in minor or moderate injury.

 Warning, Caution	 Prohibitive Action	 Mandatory Action
--	--	--

Safety instructions for the operator

 WARNING	
	Do not open the equipment. Only qualified personnel should work inside the equipment.
	Do not disassemble or modify the equipment. Fire, electrical shock or serious injury can result.
	Immediately turn off the power at the power source if <ul style="list-style-type: none"> • water leaks into the equipment • something is dropped into the equipment • the equipment is emitting smoke or is on fire • the equipment is emitting strange noises Continued use of the equipment can cause fire or electrical shock. Contact a FURUNO dealer or agent for service.
	Do not operate the equipment with wet hands. Electrical shock can result.
	Use the proper fuse. Use of the wrong fuse can cause fire or electrical shock.

 WARNING	
	Do not place liquid-filled containers on the top of the equipment. Fire or electrical shock can result if a liquid spills into the equipment.
	Make sure no rain or water splash leaks into the equipment. Fire or electrical shock can result if water leaks into the equipment.

Warning labels are attached to the equipment. Do not remove these labels. If a label is missing or illegible, contact a FURUNO agent or dealer about replacement.

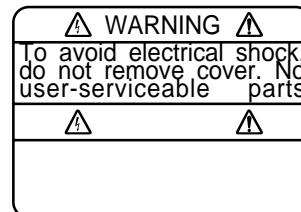

Name: Warning Label (1)
Type: 86-003-1011-1
Code No.: 100-236-231

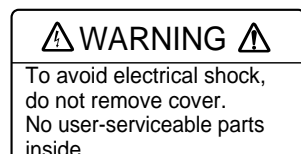

Name: Warning Label (2)
Type: 86-129-1001-1
Code No.: 100-236-741

Safety instructions for the installer

⚠ WARNING

! Turn off the power at the switchboard before beginning the installation.

Fire or electrical shock can result if the power is left on.

⊘ Do not install the equipment where it may get wet from rain or water splash.

Water in the equipment can result in fire, electrical shock or damage to the equipment.

! Be sure that the power supply is compatible with the voltage rating of the equipment.

Connecting an incompatible power supply can cause fire or damage the equipment. The voltage rating appears on the inlet of power.

⚠ CAUTION

! Observe the following compass safe distances to prevent interference to a magnetic compass:

	Standard compass	Steering compass
FA-30	0.30 m	0.30 m

TABLE OF CONTENTS

- FOREWORD v**
- SYSTEM CONFIGURATION..... vi**
- 1. INSTALLATION 1**
 - 1.1 Equipment Lists 1
 - 1.2 AIS Receiver FA-30 2
 - 1.3 Whip Antenna 3
 - 1.4 Wiring 4
- 2. WEB SOFTWARE SETUP, DATA DISPLAYS 6**
 - 2.1 AIS Receiver FA-30 6
 - 2.2 COM Port Setup, Network Setup..... 7
 - 2.3 Own Vessel Data Display, Channel Selection 10
 - 2.4 Sensor Status 12
- 3. MAINTENANCE, TROUBLESHOOTING..... 13**
 - 3.1 Maintenance 13
 - 3.2 Replacing the Fuse..... 14
 - 3.3 Troubleshooting 14
 - 3.4 Diagnostics 15
- Appendix 1: VHF CHANNEL LIST.....AP-1**
- Appendix 2: MOUNTING VHF SPLITTERAP-2**
- SPECIFICATIONS.....SP-1**
- OUTLINE DRAWINGS D-1**
- INTERCONNECTION DIAGRAM..... S-1**

FOREWORD

A Word to the Owner of the FA-30

Congratulations on your choice of the FURUNO FA-30 AIS Receiver. We are confident you will see why the FURUNO name has become synonymous with quality and reliability.

Since 1948, FURUNO Electric Company has enjoyed an enviable reputation for quality marine electronics equipment. This dedication to excellence is furthered by our extensive global network of agents and dealers.

This equipment is designed and constructed to meet the rigorous demands of the marine environment. However, no machine can perform its intended function unless operated and maintained properly. Please carefully read and follow the recommended procedures for operation and maintenance.

Thank you for considering and purchasing FURUNO equipment.

Features

The FA-30 is a compact and cost effective AIS Receiver that is designed specifically for small commercial, leisure and fishing boats.

Connected to a VHF antenna it receives AIS data from AIS-equipped vessels, shore stations and navigational aids (AIS-equipped buoys, etc.). Vessel movement is plotted on a display connected to the LAN port. Data includes identity (name, call sign and MMSI), position, speed, heading, etc. of AIS-equipped vessels within VHF range.

Program Version

Item	Program No.	Version No.	Date
FA-30 AIS Receiver Main Program	0550227	01.02	May 2007

SYSTEM CONFIGURATION

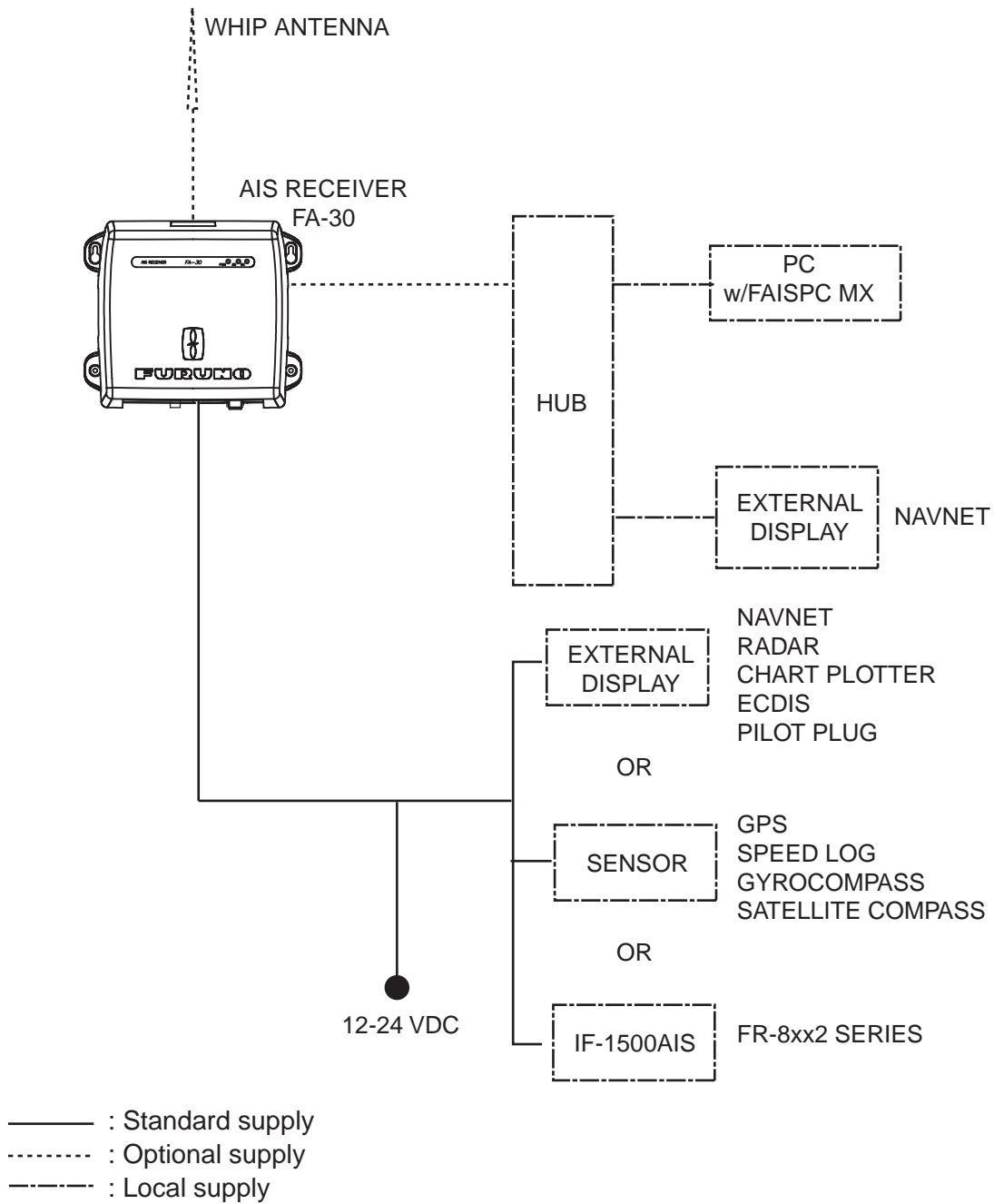

1. INSTALLATION

1.1 Equipment Lists

Standard supply

Name	Type	Code No.	Qty	Remarks
AIS Receiver	FA-30	-	1	
Installation Materials	CP05-11101	001-014-160	1 set	Tapping screw (4x20, 4 pcs.)
AIS Viewer	FP05-05910	000-010-938	1 set	FAISPC-MX for PC
Spare Parts	SP05-05701	001-014-150	1 set	2A fuse, 2 pcs.

Optional supply

Name	Type	Code No.	Qty	Remarks
VHF Antenna	150M-W2VN	000-113-498	1	
LAN Cable	P5E-4PTX-BL	000-164-634-10	1	2 m, RJ45-RJ45
	P5E-4PTX-BL	000-164-637-10		10 m, RJ45-RJ45
	MJ-A6SPF0017-010C	000-159-704-11	1	1 m, RJ45-MJ6
	MJ-A6SPF0017-050C	000-159-705-11		5 m, RJ45-MJ6
	MJ-A6SPF0017-100C	000-159-706-11		10 m, RJ45-MJ6
	MJ-A6SPF0017-200C	000-159-707-11		20 m, RJ45-MJ6
	MJ-A6SPF0017-300C	000-159-708-11		30 m, RJ45-MJ6
VHF Splitter	OP05-106	000-011-704	1	

1.2 AIS Receiver FA-30

Mounting considerations, mounting

The FA-30 can be mounted on a desktop, deck or on a bulkhead. When selecting a mounting location, keep the following points in mind:

- The temperature and humidity should be moderate and stable.
- Locate the unit away from exhaust pipes and vents.
- The mounting location should be well ventilated.
- Mount the unit where shock and vibration are minimal.
- Keep the unit away from electromagnetic field-generating equipment such as motors and generators.
- A magnetic compass will be affected if the FA-30 is placed too close to it. Observe the compass safe distances noted in the safety instructions to prevent disturbance to the magnetic compass.
- Fix the unit to the mounting location with 4x20 self-tapping screws (supplied).

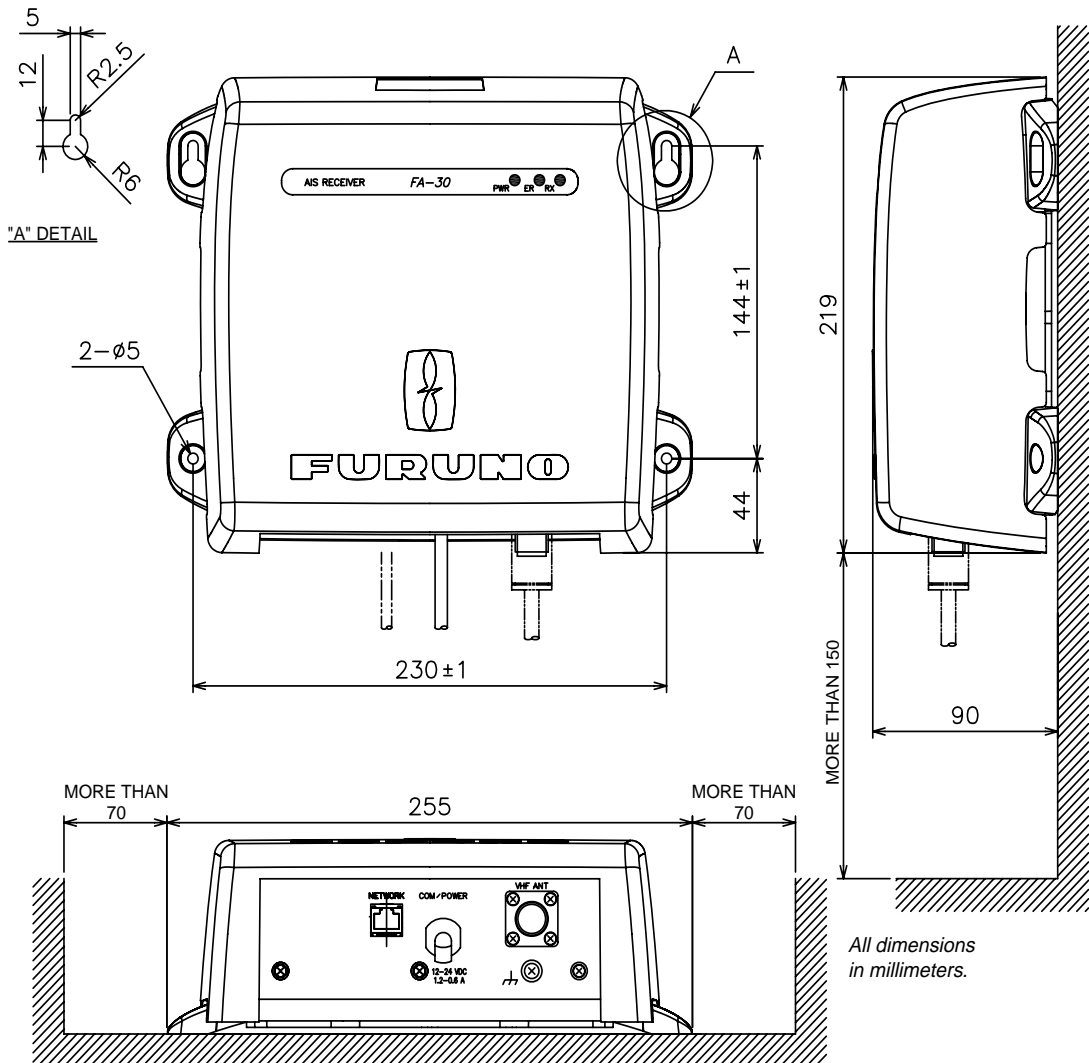

1.3 Whip Antenna

Location

The location of the AIS VHF-antenna should be carefully considered. Digital communication is more sensitive than analog/voice communication to interference created by reflections in obstructions like masts and booms. It may be necessary to relocate the VHF radiotelephone antenna to minimize interference effects. To minimize interference effects, the following guidelines apply:

- The AIS VHF antenna should be placed in an elevated position that is as free as possible with a minimum of 0.5 meters in the horizontal direction from constructions made of conductive materials. The antenna should not be installed close to any large vertical obstruction. The objective for the AIS VHF antenna is to see the horizon freely through 360 degrees.
- There should not be more than one antenna on the same plane. The AIS VHF antenna should be mounted directly above or below the ship's primary VHF radiotelephone antenna, with no horizontal separation and with a minimum of 2.8 meters vertical separation. If it is located on the same plane as other antennas, the distance apart should be at least 10 meters.
- Install the VHF whip antenna (option) referring to the outline drawing at the back of this manual. Separate this antenna from other VHF radiotelephone antennas as shown below to prevent interference to the FA-30.

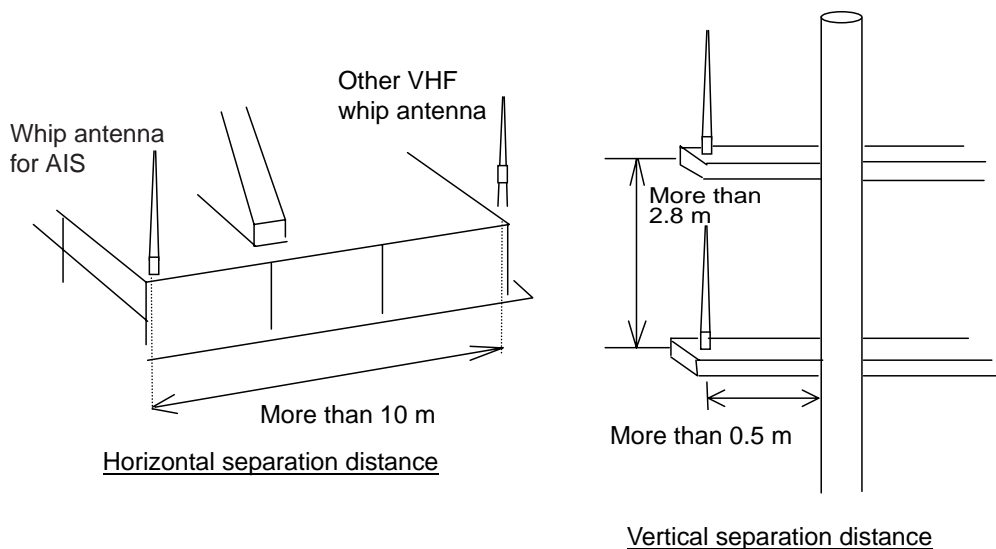

Cabling

- Use coaxial cable type 5D-2V or the equivalent.
- The cable should be kept as short as possible to minimize signal attenuation, and the maximum length is 50 meters.
- All outdoor-installed connectors on coaxial cables should be fitted with preventive isolation such as vulcanizing tape to protect against water penetration into the antenna cable.
- Coaxial cables should be installed in separate signal cable channels/tubes and at least 10 cm away from power supply cables. Crossing of cables should be done at right angles (90 degrees). The minimum bend radius of the coaxial cable should be 5 times the cable's outer diameter.

1.4 Wiring

Connect power source, LAN cable, VHF antenna and ground wire as shown below.

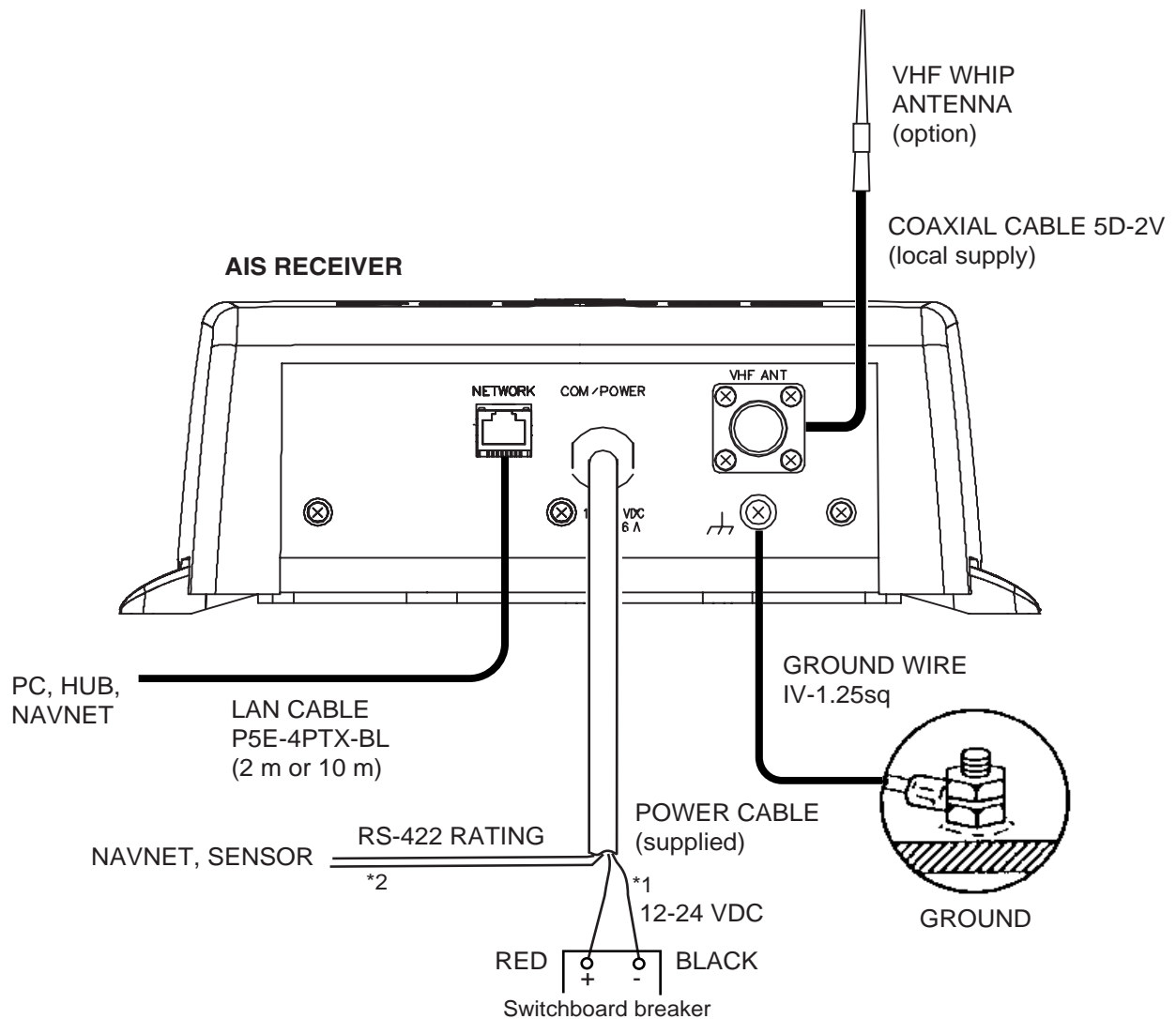

*1 Supply from breaker on switchboard.

*2 If COM lines (connection for NavNet, sensor) are not used, tape them to prevent short circuit.

Attaching coaxial connector (M-P-5) to coaxial cable

The antenna cable (coaxial cable, type 5D-2V) is terminated at the FA-30 with an M-P-5 coaxial connector. Attach the connector to the cable as shown below.

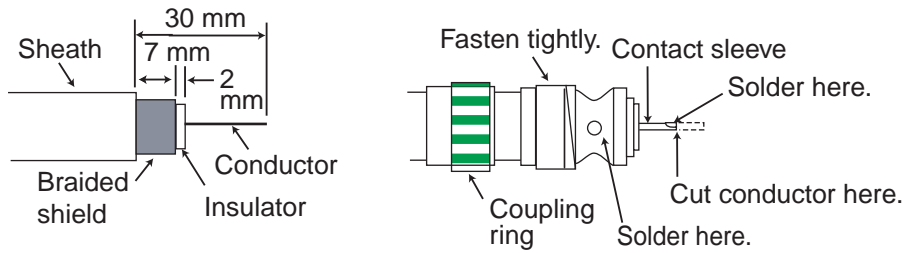

Connection of AIS viewer (FAISPC-MX)

The AIS viewer may be connected to the FA-30 directly, or to both FA-30 and NavNet vx2. See the figure below for connection examples.

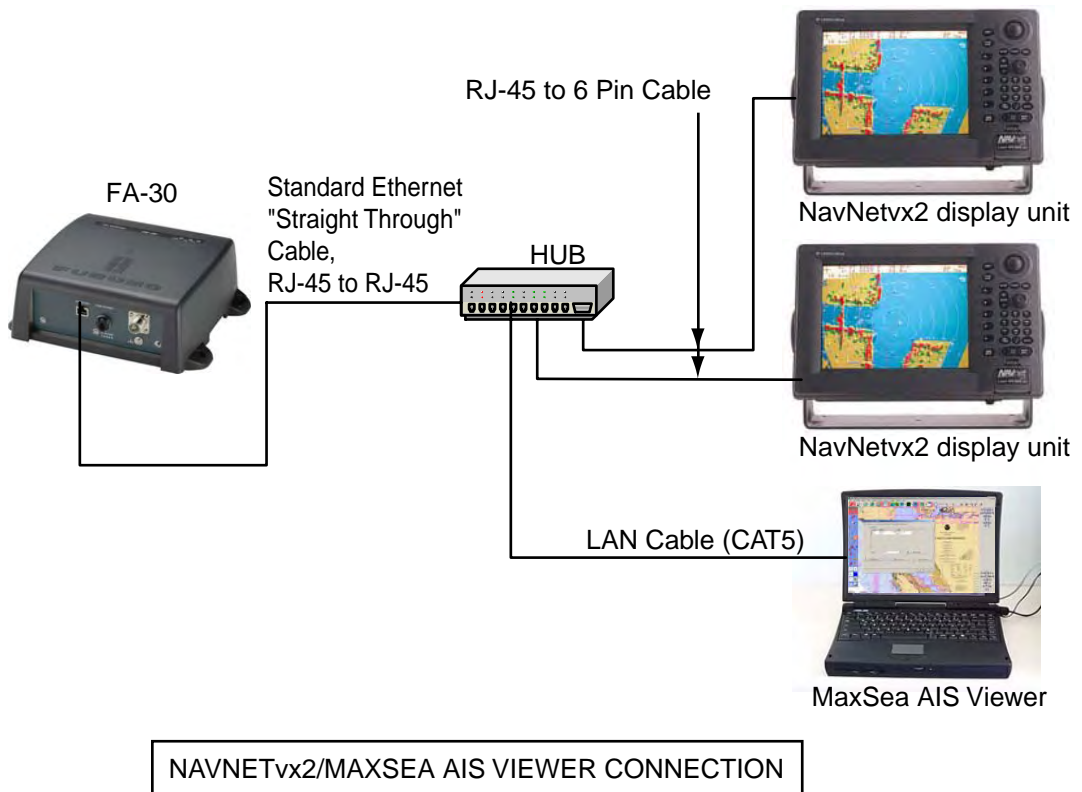
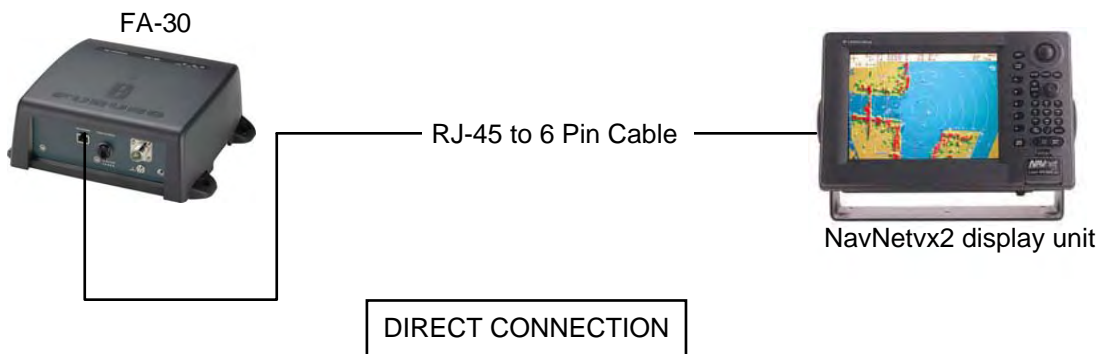

2. WEB SOFTWARE SETUP, DATA DISPLAYS

2.1 AIS Receiver FA-30

The FA-30 has no power switch. Power is fed from the ship's switchboard, and a power switch on the switchboard turns the FA-30 on or off. When powered, the PWR LED (green) on the cover lights. The two other LEDs on the cover flash or light with equipment state. The ER LED (red) lights while the equipment is being initialized, and flashes when equipment error is found. The RX LED (orange) lights when receiving.

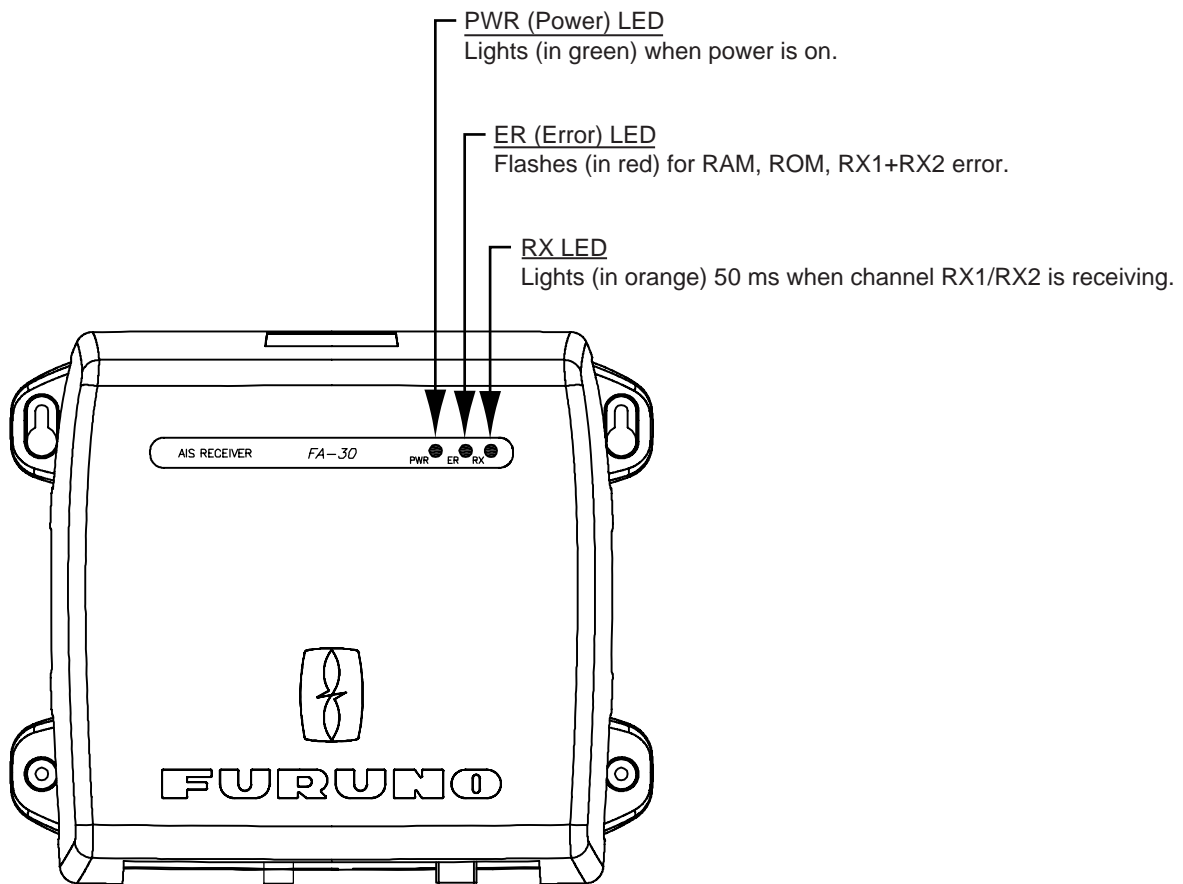

2.2 COM Port Setup, Network Setup

The FA-30 is set up from the PC or external display. The procedure below shows how to set up the COM/POWER and NETWORK ports from a PC.

NOTICE: Only one FA-30 may be connected to the network.

Start up

1. Start up the PC and enter IP address and subnet mask.
 - 1) Right-click My Network and Properties.
 - 2) Right-click Local Area Network and Properties.
 - 3) Select Internet Protocol and Properties.
 - 4) Enter IP address 172.31.24.xxx (xxx=any three digits from 001 to 254, except 002).
 - 5) Enter subnet mask 255.255.0.0.
2. Open Internet Explorer and do the following:
 - 1) Click Tools on the menu bar.
 - 2) Click Internet Options.
 - 3) The General tab is selected. Click Settings at Temporary Internet Files.
 - 4) Click the radio button "Every visit to the page" at "Check for newer versions of stored page".
 - 5) Click the OK button.
 - 6) Click the OK button again.
3. Enter URL as `http://172.31.24.2` and press the Enter key.

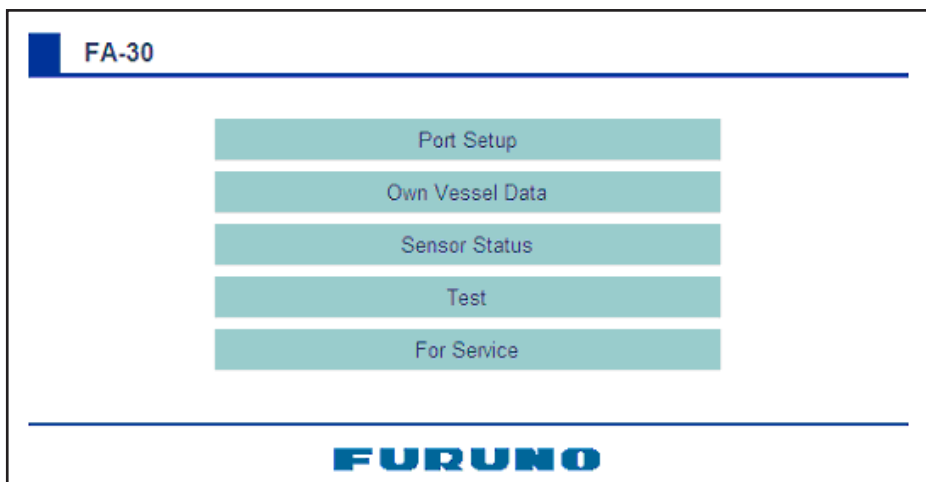

4. Click Port Setup to show the Port Setup menu.

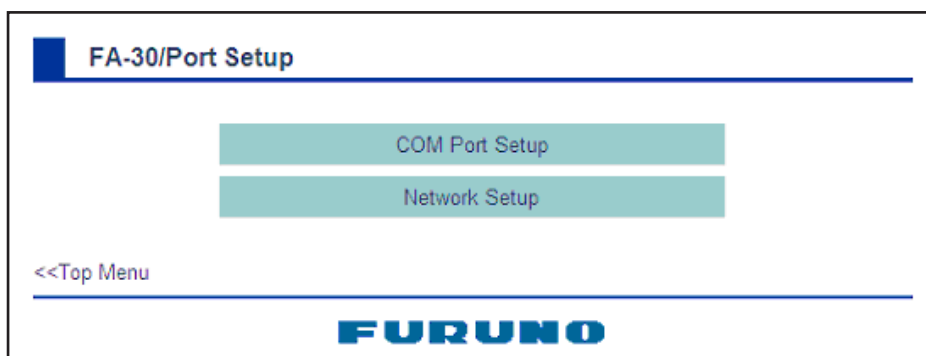

COM port setup

5. Click COM PORT Setup to show the COM Port Setup menu.

FA-30/COM Port Setup

Data Type IEC61162 (default=IEC61162)

TX Speed 38400 bps

RX Speed Auto Manual 4800 bps (default=Auto)

OK Cancel

<<Port Setup

FURUNO

6. The default setting for Data Type is IEC61162, which is suitable for most installations. If change is necessary, click the Data Type drop-down list and choose data type as applicable, among the following choices.

IEC61162

IEC61162

IEC61162+P-sentence

Off

IEC61162: Transmit and receive IEC61162 format data via COM port. (P sentences are received but not transmitted.)

IEC61162+ P-sentence: Transmit and receive IEC61162+P sentences format data via COM port.

Off: FA-30 transmits no data.

With the radio buttons at RX Speed, choose how RX speed is regulated, Auto or Manual. For manual, choose speed from the drop-down list.

4800 bps

4800 bps

38400 bps

Note: Tx speed is fixed at 38400 bps.

7. Click OK to confirm setting.
8. Click "<<Port Setup" to return to the Port Setup menu.

NETWORK setup

9. Click Network Setup to show the Network Setup menu.

MAC Address	00-D0-1D-02-FA-50	
IP Address	<input type="text" value="172.031.024.002"/>	(default=172.031.024.002)
Subnet Mask	<input type="text" value="255.255.000.000"/>	(default=255.255.000.000)
Gateway Address	<input type="text" value="000.000.000.000"/>	(default=000.000.000.000)
NavNet Port Number	<input type="text" value="10000"/>	(default=10000)
Host Name	<input type="text" value="AIS0"/>	(default=AIS0)
AIS Data Output	<input type="text" value="Continuous"/>	(default=Continuous)

<<Port Setup

FURUNO

10. Enter the IP address assigned to the FA-30.

11. Enter subnet mask for the network.

12. Enter gateway address.

13. For NavNet connection, enter NavNet port number at NavNet Port Number. Enter ten-thousandths and one-thousandths places.

14. At Host Name, enter host name to be used in NavNet, AIS0 - AIS9.

15. At AIS Data Output, select how to output AIS data.

Auto: Auto-detect of where to output AIS data.

Continuous: Output data continuously. Select if interfaced with FAISPC_MX.

Note: It is not necessary to change the settings of NavNet Port Number, Host Name and AIS Data Output. Connection is available without adjusting them.

16. Click the OK button to finish.

17. If you changed a setting, the message below appears.

You must restart your FA-30
before the new settings take effect.
Do you want to restart your FA-30 now?
(It will take about 1 minute to restart your FA-30).

18. Click the Yes button to restart. "ER" LED on the FA-30 lights. After the LED goes off access is given.

19. The message "Please close the window." appears. Close the browser.

After restart is completed, it is necessary to access the FA-30 using new values. For example, if you changed the IP address, use the new address to access the FA-30.

2.3 Own Vessel Data Display, Channel Selection

The Own Vessel Data display shows your ship's MMSI no., RX channel nos., and channel selection method.

1. Show the main menu, referring to section 2.2.
2. Click Own Vessel Data.

MMSI	-----
RX1	CH. 2087 (International)
RX2	CH. 2088 (International)
Channel Selection	Auto

<<Top Menu

FURUNO

Description of own vessel data

MMSI: MMSI number (nine-digit number).

RX1: Channel (four digits) received over RX1. Channel type (International, Local) is shown in parentheses.

RX2: Channel (four digits) received over RX2. Channel type (International, Local) is shown in parentheses.

Channel Selection: Current channel selection method, Auto or Manual, is shown. For how to change channels, go to the next step.

3. Click the Edit button to show the Channel menu.

RX1	2087	(default=2087)
RX2	2088	(default=2088)
RX Mode	RX 1+2	(default=RX 1+2)
Channel Selection	Auto	(default=Auto)

When setting channels manually, confirm that channels are usable in current region, AIS information cannot be received in the regions where selected channel is not available.

OK Cancel

<<Own Vessel Data

FURUNO

4. Enter channel no. (four digits) at RX1 and RX2.

5. Click the RX Mode drop-down list to choose which channel(s) to receive.



RX 1+2: Receive via channels 1 and 2.

RX 1: Receive via channel 1.

RX 2: Receive via channel 2.

6. Click the Channel Selection drop-down list.

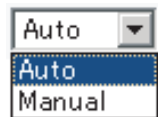

7. Choose Manual.

8. Click the OK button to finish. The Own Vessel Data menu appears.

To return to automatic channel selection, open the Channel menu, choose Auto at Channel Selection and click the OK button. CH2087 and CH2088 are automatically selected.

2.4 Sensor Status

The sensor status display provides information about sensors connected to the FA-30.

1. Show the main menu, referring to section 2.2.
2. Click Sensor Status. The illustration below shows typical sensor status indications.

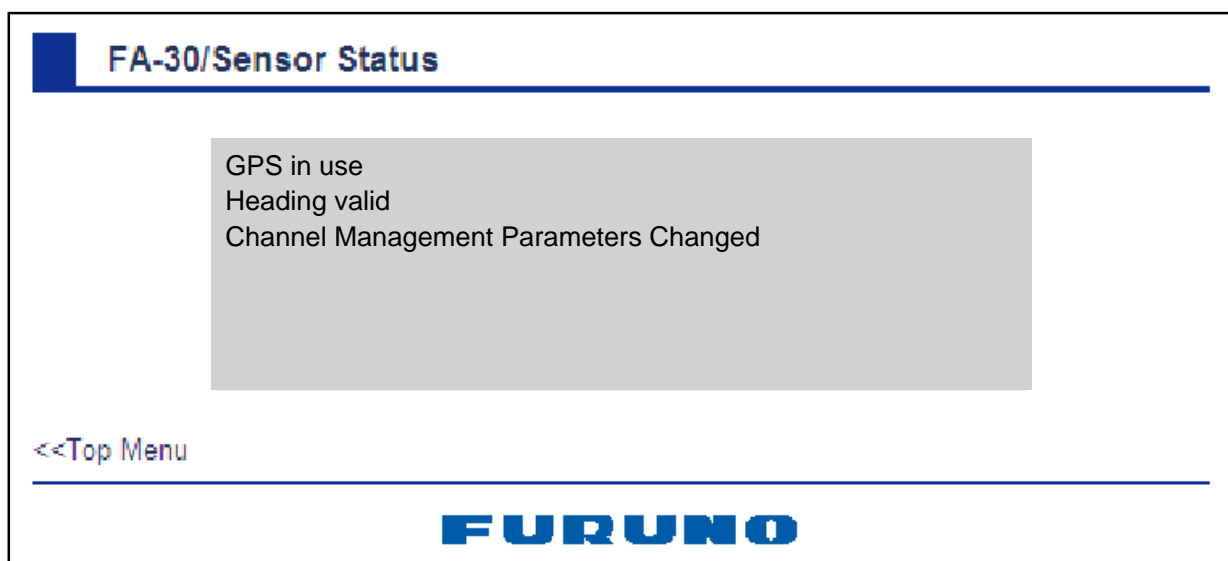

Description of sensor status indications

Indication	Meaning	Remarks
DGPS in use	DGPS currently in use	See *1
GPS in use	GPS currently in use	See *1
SOG/COG in use	SOG/COG currently in use	
Heading valid	Valid heading data	
Channel Management Parameters Changed	Channel parameters have been changed.	See *2

*1 Whichever navigator is in use.

*2 Displayed for 30 seconds after changing channel parameters. (It is necessary to update the display.)

3. MAINTENANCE, TROUBLESHOOTING

⚠ WARNING	
	<p>Do not open the equipment unless totally familiar with electrical circuits and service manual.</p> <p>Only qualified personnel should work inside the equipment.</p>

NOTICE
<p>Do not apply paint, anti-corrosive sealant or contact spray to coating or plastic parts of the equipment.</p> <p>Those items contain organic solvents that can damage coating and plastic parts, especially plastic connectors.</p>

3.1 Maintenance

Regular maintenance helps maintain good performance. Check the items listed below at least monthly to help keep your equipment in good working order.

Maintenance table

Item	Check point, remedy
Wiring	Check that each cable and wire are securely fastened. Refasten if necessary.
Ground	Check ground point for rust. Clean if necessary.
VHF antenna	Check VHF antenna and its cabling for damage. Replace if necessary.
Cabinet	Dust and dirt should be removed from the cabinet with a soft, dry cloth. Do not use chemical-based cleaners; they can remove paint and markings.

3.2 Replacing the Fuse

The fuse (2A) inside the FA-30 protects it from overcurrent and equipment fault. If the unit cannot be powered, that is, the PWR (power) LED is off, the fuse may have blown. If this happens, turn off the power to the FA-30, open the cover and check the fuse. If the fuse has blown, find out the reason before replacing it. If it blows again after replacement, contact a FURUNO agent or dealer for advice.

Part	Type	Code No.
Fuse (2A)	FGMB AC125V 2A PBF	000-157-479-10

WARNING

Use the proper fuse.

Use of a wrong fuse can result in damage to the equipment and cause fire.

3.3 Troubleshooting

The troubleshooting table below provides typical operating problems and the means to restore normal operation. If you cannot restore normal operation, do not attempt to check inside the receiver; there are no user serviceable parts inside the receiver.

Troubleshooting table

Symptom	Problem	Remedy
Receiver cannot be powered.	Fuse inside the receiver may have blown.	Replace the fuse.
Cannot receive.	<ul style="list-style-type: none">• VHF antenna may have loosened.• Antenna or its cabling may be damaged.• Rx channel is malfunctioning.	<ul style="list-style-type: none">• Check if the antenna is firmly fastened.• Check the antenna and its cabling for damage.• Confirm the channel setting.

3.4 Diagnostics

The built-in diagnostic facility displays program version no. and checks RAM, ROM and RX channels for proper operation.

1. Open Internet Explorer and show the main menu.
2. Click Test to show the Test display.

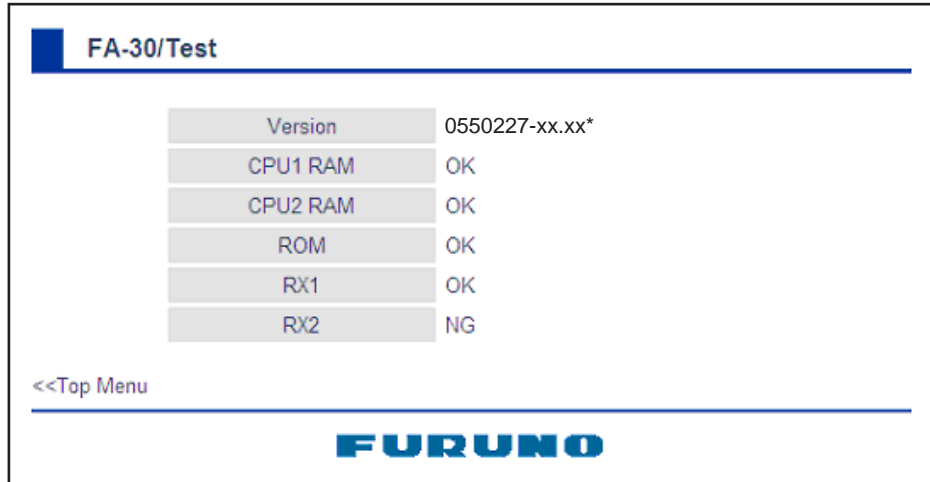

*xx.xx is program version.

The program version number appears on the first line. The CPU1 RAM and CPU2 RAM, ROM and the two RX channels are checked for proper operation, and the results are displayed as OK or NG (No Good). For any NG, try resetting the power and checking connections. If NG condition persists, contact your dealer for advice.

Appendix 1: VHF CHANNEL LIST

Ch No.	Frequency	Ch No.	Frequency	Ch No.	Frequency	Ch No.	Frequency
1001	156.05	1088	157.425	277	156.8875	2079	161.575
1002	156.1	1201	156.0625	1278	156.9375	2080	161.625
1003	156.15	1202	156.1125	1279	156.9875	2081	161.675
1004	156.2	1203	156.1625	1280	157.0375	2082	161.725
1005	156.25	1204	156.2125	1281	157.0875	2083	161.775
6	156.3	1205	156.2625	1282	157.1375	2084	161.825
1007	156.35	1206	156.3125	1283	157.1875	2085	161.875
1018	156.9	1207	156.3625	1284	157.2375	2086	161.925
1019	156.95	208	156.4125	1285	157.2875	2087	161.975
1020	157	209	156.4625	1286	157.3375	2088	162.025
1021	157.05	210	156.5125	1287	157.3875	2201	160.6625
1022	157.1	211	156.5625	2001	160.65	2202	160.7125
1023	157.15	212	156.6125	2002	160.7	2203	160.7625
1024	157.2	213	156.6625	2003	160.75	2204	160.8125
1025	157.25	214	156.7125	2004	160.8	2205	160.8625
1026	157.3	215	156.7625	2005	160.85	2206	160.9125
1027	157.35	216	156.8125	2007	160.95	2207	160.9625
1028	157.4	217	156.8625	8	156.4	2218	161.5125
1060	156.025	1218	156.9125	9	156.45	2219	161.5625
1061	156.075	1219	156.9625	10	156.5	2220	161.6125
1062	156.125	1220	157.0125	11	156.55	2221	161.6625
1063	156.175	1221	157.0625	12	156.6	2222	161.7125
1064	156.225	1222	157.1125	13	156.65	2223	161.7625
1065	156.275	1223	157.1625	14	156.7	2224	161.8125
1066	156.325	1224	157.2125	15	156.75	2225	161.8625
67	156.375	1225	157.2625	16	156.8	2226	161.9125
68	156.425	1226	157.3125	17	156.85	2227	161.9625
69	156.475	1227	157.3625	2018	161.5	2228	162.0125
70	156.525	1228	157.4125	2019	161.55	2260	160.6375
71	156.575	1260	156.0375	2020	161.6	2261	160.6875
72	156.625	1261	156.0875	2021	161.65	2262	160.7375
73	156.675	1262	156.1375	2022	161.7	2263	160.7875
74	156.725	1263	156.1875	2023	161.75	2264	160.8375
75	156.775	1264	156.2375	2024	161.8	2265	160.8875
76	156.825	1265	156.2875	2025	161.85	2266	160.9375
77	156.875	1266	156.3375	2026	161.9	2278	161.5375
1078	156.925	267	156.3875	2027	161.95	2279	161.5875
1079	156.975	268	156.4375	2028	162	2280	161.6375
1080	157.025	269	156.4875	2060	160.625	2281	161.6875
1081	157.075	270	156.5375	2061	160.675	2282	161.7375
1082	157.125	271	156.5875	2062	160.725	2283	161.7875
1083	157.175	272	156.6375	2063	160.775	2284	161.8375
1084	157.225	273	156.6875	2064	160.825	2285	161.8875
1085	157.275	274	156.7375	2065	160.875	2286	161.9375
1086	157.325	275	156.7875	2066	160.925	2287	161.9875
1087	157.375	276	156.8375	2078	161.525		

Appendix 2: MOUNTING VHF SPLITTER

The VHF splitter enables the AIS receiver and VHF transceiver to share a single VHF antenna.

Note: The FA-30 can not receive AIS signal when the VHF transceiver is transmitting.

Equipment Lists

VHF Splitter: Type OP05-106, Code No. 000-011-704

No.	Name	Type	Code No.	Qty	Remarks
1	VHF Splitter Assembly	OP05-106-1	001-024-100	1	Rear panel + pcb 05P0817
2	Installation Materials	CP05-11301	001-024-110	1	Cable tie CV-70N, 1 pc.

Mounting procedure

1. Open the detachable cover.

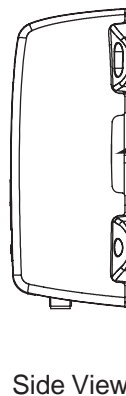
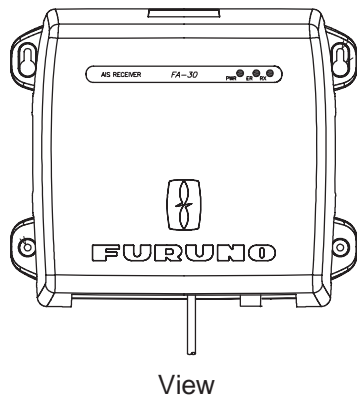

1. Put fingers on both sides and pull outwards and lift up to take off.

2. Unfasten four screws to separate the chassis from the mounting plate.

2. Unfasten four screws.

3. Disconnect plugs on J7, J12 and the ground wire from pcb 05P0807 .

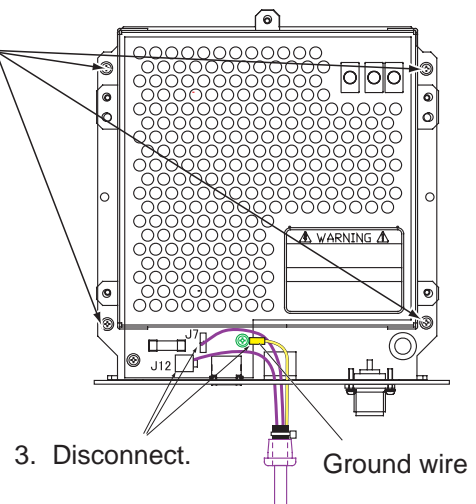

4. Turn over the chassis. Then, disconnect mini coaxial wire from J2 on pcb 05P0808A.

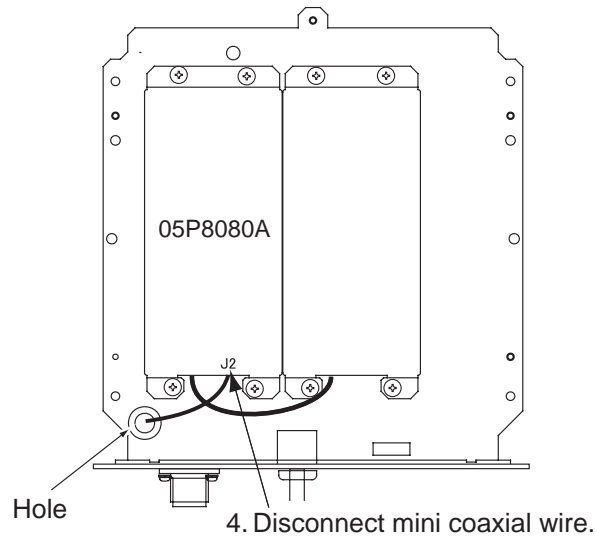

Bottom view

5. Unfasten four screws from the rear panel to come free.

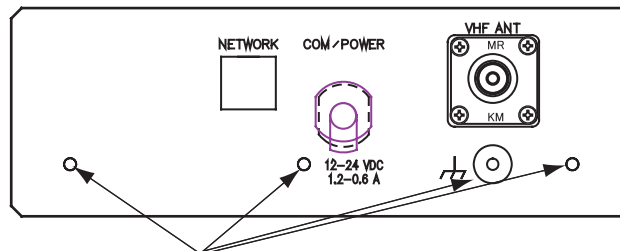

5. Unfasten four screws.

Rear panel

6. Pull out the cable assembly from the rear panel. (The rear panel may be discarded.)

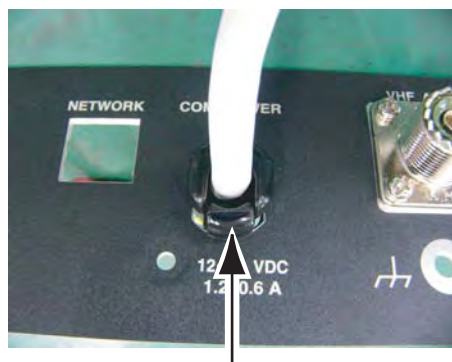

6. Push strongly here and pull out the cable.

7. Pass the cable assembly to the new rear panel.

8. Connect the plugs and ground wires to original places.

9. Pass two wires (two-core power cable and mini coaxial cable) from pcb 05P0817 on the new rear panel through the hole on the chassis.

Pass two-core power cable and then mini coaxial cable.

10. Fix the new rear panel to the chassis with original four screws.

11. Connect the plug of mini coaxial wire to J2 on pcb 05P0808A.

12. Connect two-core power cable to J3 on pcb 05P0808B.

13. Tie two cables with a cable tie.

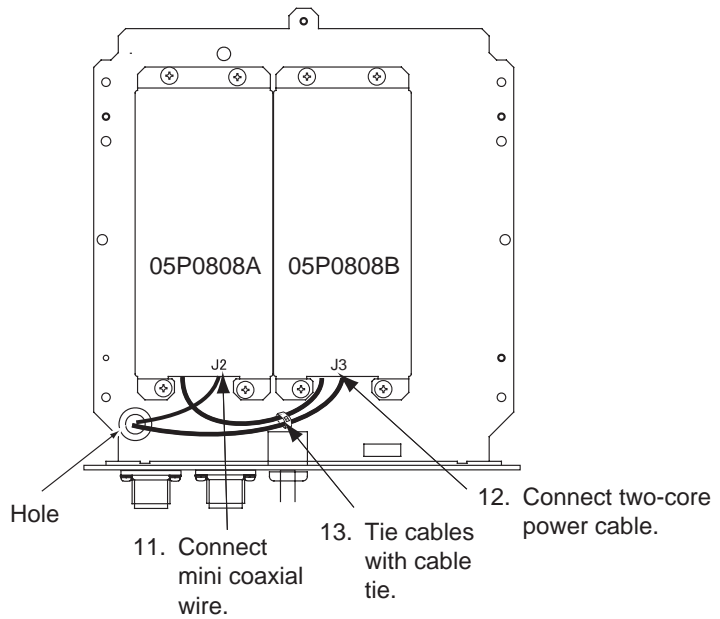

Bottom view of the chassis

14. Reassemble the chassis.

15. Connect the coaxial cable from the VHF antenna to the ANT port.

16. Connect the coaxial cable from the VHF transceiver to the VHF port.

Note: The wrong connection of coaxial cable from VHF antenna or VHF transceiver may damage this equipment.

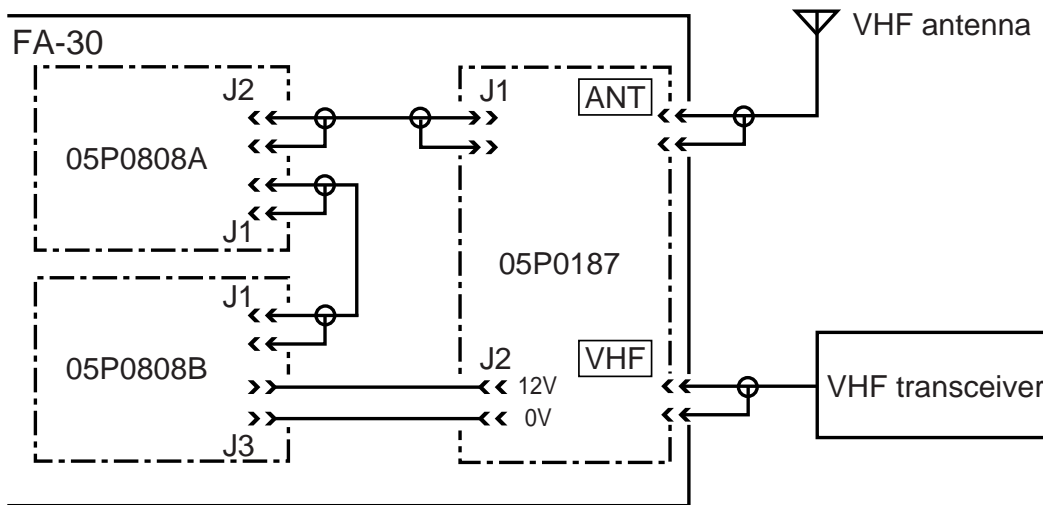

**SPECIFICATIONS OF AIS RECEIVER
FA-30**

1. GENERAL

- 1.1 Rx Capacity 2250 reports/minute, 1 channel
 4500 reports/minute, 2 channels
- 1.2 Rx System TDMA dual wave simultaneous reception
- 1.3 Frequency Switching Automatic (external device)
- 1.4 Complying Regulations IEC 60945 Ed. 4, and receiver section conforms to IEC 61993-2,
 IEC 62287-1, ITU-R M.1371-1,

2. AIS RECEIVER (RX1/RX2)

- 2.1 Rx Frequency Range 156.025 MHz to 162.025 MHz
- 2.2 Channel Interval 25 kHz/12.5 kHz
- 2.3 Oscillator Frequency 1st local oscillator f+(51.136 MHz/51.236 MHz)
 2nd local oscillator 51.1 MHz/51.2 MHz
- 2.4 Intermediate Frequency 1st IF 51.136 MHz/51.236 MHz
 2nd IF 36 kHz
- 2.5 Rx System Double superheterodyne
- 2.6 Sensitivity -107 dBm (PER less than 20%)
- 2.7 Error Characteristics -77 dBm (PER less than 2%)
 -7 dBm (PER less than 10%)
- 2.8 Channel Rej. Better than -10 db
- 2.9 Adjacent Channel Rej. Better than 70 dB (± 25 kHz)
- 2.10 Spurious Response Better than 70 dB (50 MHz – 520 MHz)
- 2.11 Mutual Modulation Wanted freq. f – 101 dBm
 Characteristic Unwanted freq. f ± 50 kHz, no modulation –36 dBm
 f ± 100 kHz, 400 Hz/ ± 3 kHz modulation –36 dBm
 PER less than 20%
- 2.12 Sensitivity Suppression Wanted freq. f –101 dBm
 Unwanted freq. f ± 500 kHz, ± 1 MHz, ± 2 MHz,
 no modulation –23 dBm
 Unwanted freq. f ± 5 MHz, ± 10 MHz, no modulation –15 dB
 PER less than 20%
- 2.13 Spurious Emission 9 kHz – 1 GHz less than –57 dBm
 1 GHz – 4 GHz less than –47 dBm

3. INTERFACE

- 3.1 COM port
 - Input: RS422(38.4kbps)/IEC61162-1(4800 bps)
 - Output: RS422(38.4kbps)
 - Input sentences:** ACK, ACA, DTM, GBS, GGA, GLL, GNS, HDT, OSD, RMC, VBW, VTG, DSC, DSE, AIQ, ZDA, PFEC, ABM*, BBM*, AIR*
 - Output sentences:** ACA, ACS, ALR, VDM, VDO, TXT, ABK*, PFEC
- 3.2 NETWORK
 - Ethernet 10/100BASE-T
 - Input sentences:** ACK, ACA, DTM, GBS, GGA, GLL, GNS, HDT, OSD, RMC, VBW, VTG, DSC, DSE, AIQ, ZDA, PFEC, ABM*, BBM*, AIR*
 - Output sentences:** ACA, ACS, ALR, VDM, VDO, TXT, ABK*, PFEC
 - * ABK sentence sent in response to mis-input of ABM, BBM, AIR.

4. ANTENNA

50 ohm single dipole antenna

5. POWER SUPPLY

12-24 VDC: 1.2-0.6 A

6. ENVIRONMENTAL CONDITION

- 6.1 Ambient Temperature -15°C to +55°C
- 6.2 Relative Humidity 93% at 40°C
- 6.3 Waterproofing (IEC 60529) IP20
- 6.4 Vibration (IEC 60945 ed.4)
 - 2Hz to 5 Hz and up to 13.2 Hz with an excursion of $\pm 1 \text{ mm} \pm 10\%$ (7 m/s^2 maximum acceleration at 13.2 Hz)
 - above 13.2 Hz and up to 100 Hz with a constant maximum acceleration of 7 m/s^2

7. COATING COLOR

N2.5

表 1 TABLE 1

寸法区分 (mm) DIMENSIONS	公差 (mm) TOLERANCE
$L \leq 50$	± 1.5
$50 < L \leq 100$	± 2.5
$100 < L \leq 500$	± 3

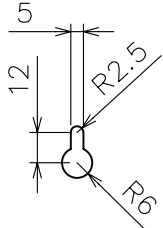
 型式銘板
NAMEPLATE

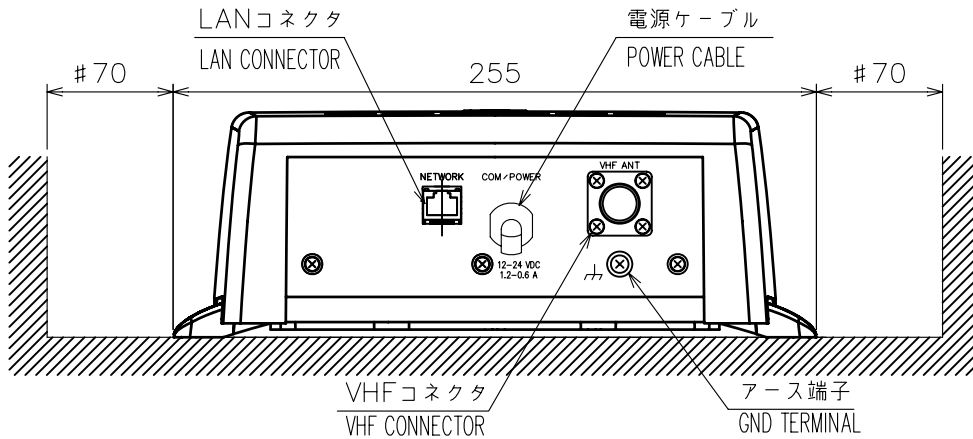
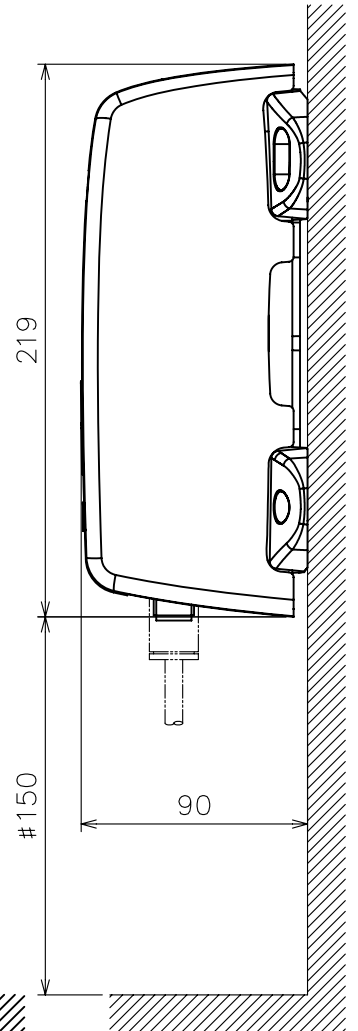
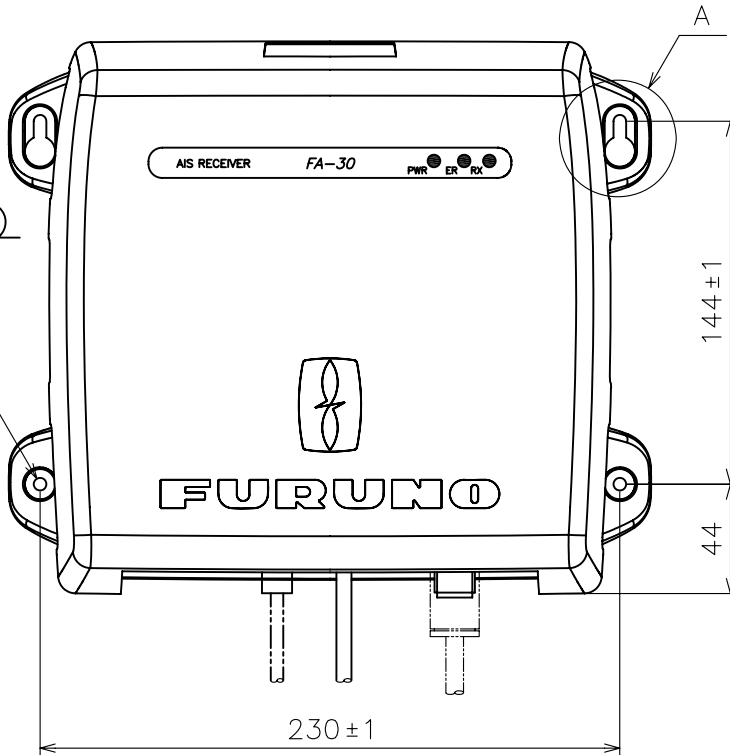
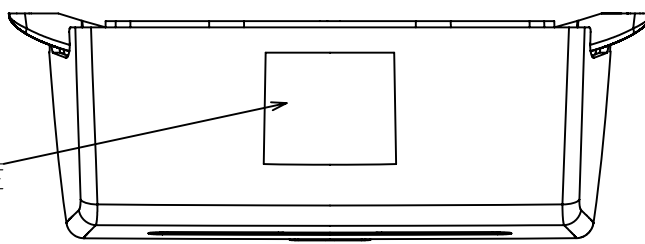
 A部詳細(2箇所)
DETAIL A

 2- $\phi 5$

- 注 記 1) #印寸法は最小サービス空間寸法とする。
 2) 指定外の寸法公差は表 1 による。
 3) 取付用ネジはトラストタッピンネジ呼び径4x20を使用のこと。
- NOTE 1. #: MINIMUM SERVICE CLEARANCE.
 2. TABLE 1 INDICATES TOLERANCE OF DIMENSIONS WHICH IS NOT SPECIFIED.
 3. USE SELF-TAPPING SCREWS 4x20 FOR FIXING THE UNIT.

DRAWN Mar. 12 '07 E. MIYOSHI	TITLE FA-30
CHECKED TAKAHASHI, T	名称 AIS受信機
APPROVED Y. Hatai	外寸図
SCALE 1/3 MASS 1.5 ±10% kg	NAME AIS RECEIVER
DWG.No. C4443-G01-A	REF.No. 05-096-250G-2
OUTLINE DRAWING	

A

B

C

D

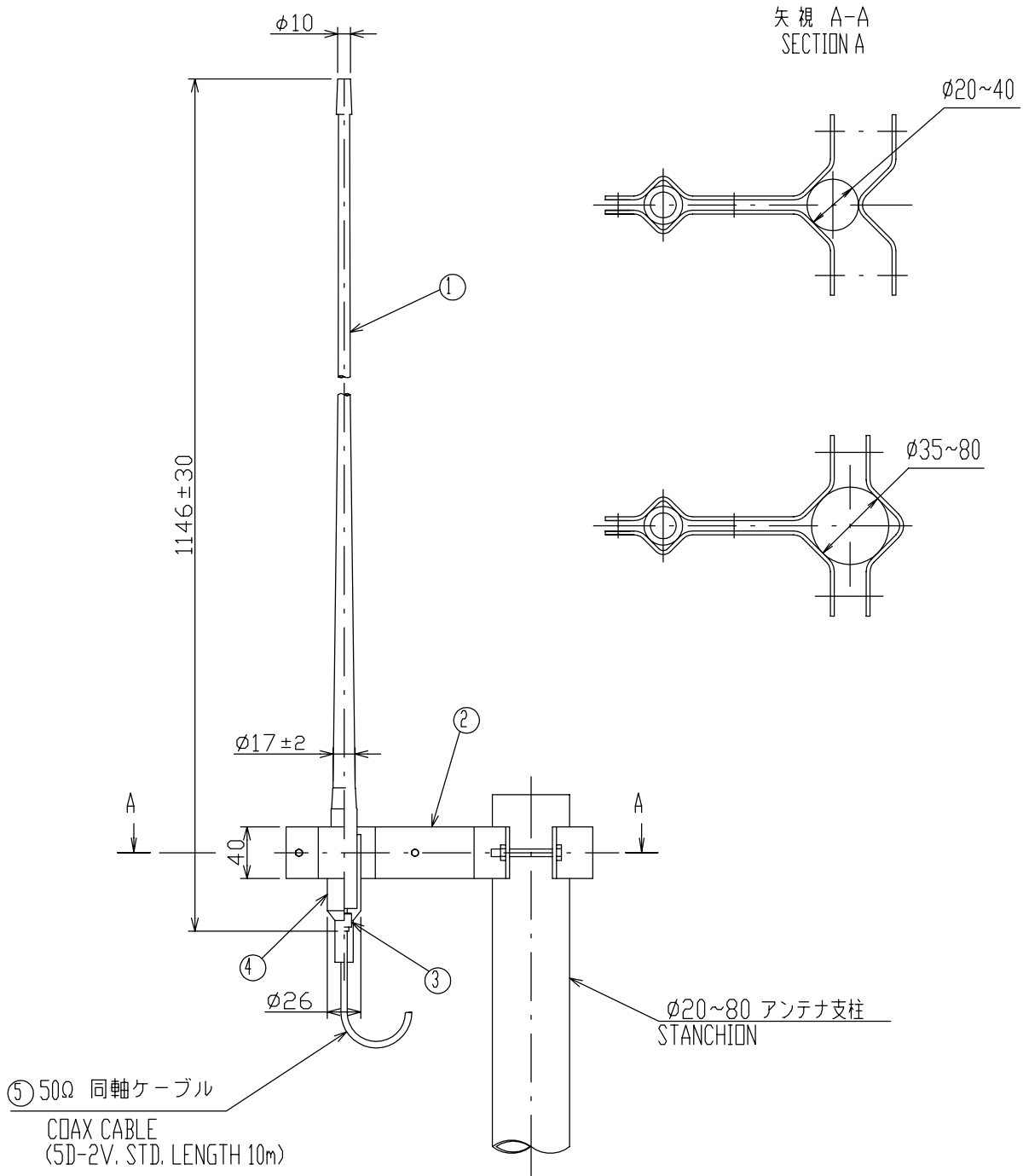

5	同軸ケーブル 50Ω COAX. CABLE		10m	5D-2V	
4	プラグキャップ CONNECTOR CAP		1		
3	同軸コネクタ COAX. CONNECTOR		2	M-P-5	
2	アンテナ取付金具 ANTENNA BRACKET		1 式 SET		t2
1	アンテナ棒 ANTENNA ELEMENT	FRP	1	150M-W2VN	0.25kg
品番 ITEM	品名 NAME	材質 MATERIAL	数量 Q.TY	図番 DWG.No.	摘要 REMARKS

DRAWN	Nov. 26 '03	T.YAMASAKI	TITLE	150M-W2VN	
CHECKED	Nov. 26 '03	T.TAKENO	名称	150MHzホイップアンテナ	
APPROVED	Nov. 28 '03	Matsuyuchi		外寸図	
SCALE	1/5	MASS 0.7 ±10% kg	NAME	150MHz WHIP ANTENNA	
DWG.No.	C5011-042- C			OUTLINE DRAWING	

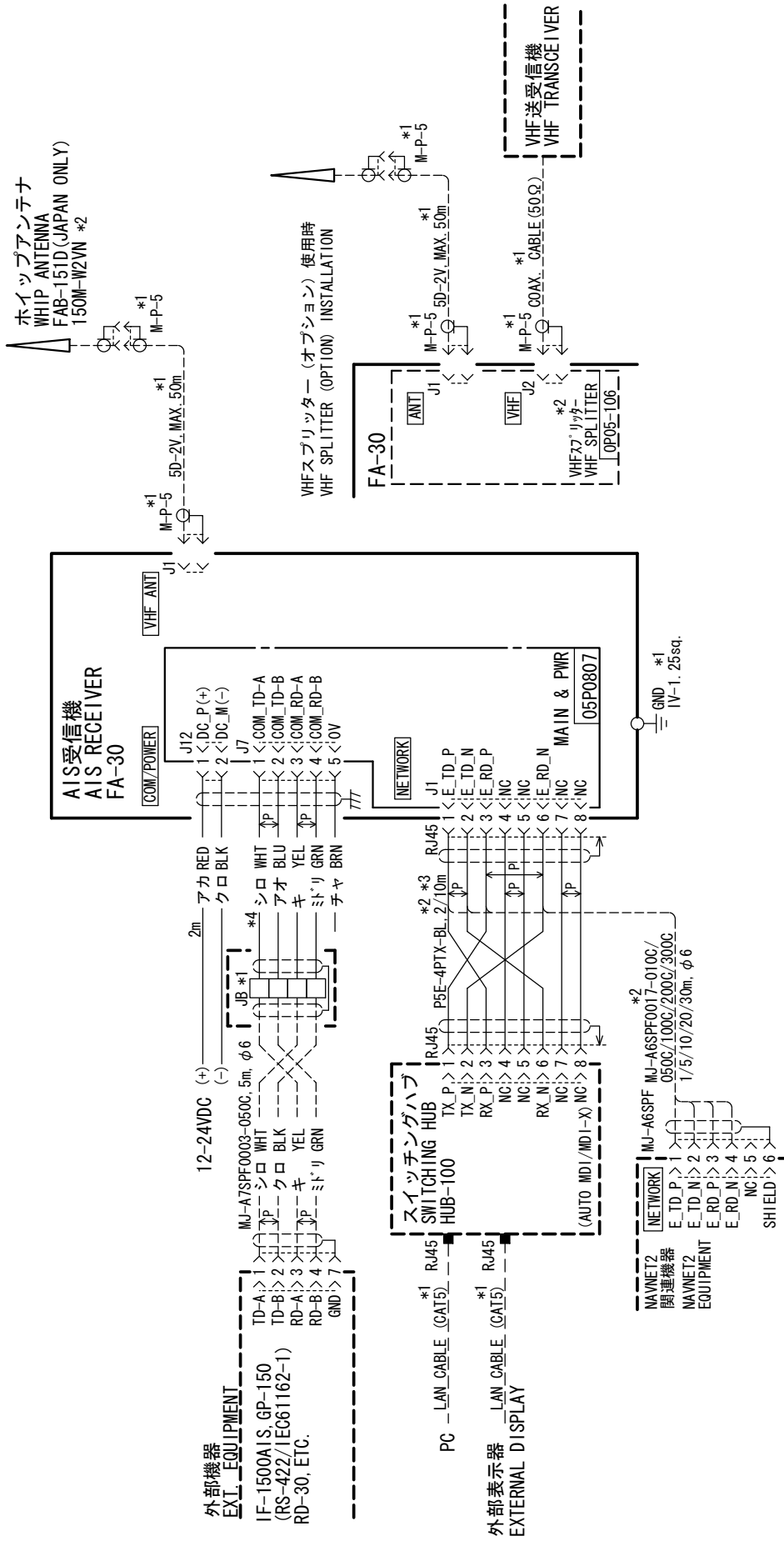

注記

- *1) 造船所手配。
- *2) オプション。
- *3) Auto MDI/MDI-X対応でないHUBのときは、ストレートケーブルを使用する。
- *4) COMラインを使用しないときは、芯線がショートしないようテープで絶縁する。

NOTE

- *1: SHIPYARD SUPPLY.
- *2: OPTION.
- *3: USE STRAIGHT LAN CABLE WHEN A HUB W/O AUTO MDI/MDI-X FUNCTION IS USED.
- *4: IF COM LINES ARE NOT USED, TAPE THEM TO PREVENT SHORT-CIRCUIT.

DRAWN	12/Nov/2010	T. YAMASAKI	TYPE	FA-30
CHECKED	12/Nov/2010	T. TAKAHASHI	名称	AIS受信機
APPROVED	12/Nov/2010	Y. NISHIYAMA	相互結線図	
SCALE	MASS	kg	NAME	AIS RECEIVER
DWG. No.	C4443-C01-F	REF. No.	05-096-2002-1	INTERCONNECTION DIAGRAM

FURUNO Worldwide Warranty for Pleasure Boats (Except North America)

This warranty is valid for products manufactured by Furuno Electric Co. (hereafter FURUNO) and installed on a pleasure boat. Any web based purchases that are imported into other countries by anyone other than a FURUNO certified dealer may not comply with local standards. FURUNO strongly recommends against importing these products from international websites as the imported product may not work correctly and may interfere with other electronic devices. The imported product may also be in breach of the local laws and mandated technical requirements. Products imported into other countries as described previously shall not be eligible for local warranty service.

For products purchased outside of your country please contact the national distributor of Furuno products in the country where purchased.

This warranty is in addition to the customer's statutory legal rights.

1. Terms and Conditions of Warranty

FURUNO guarantees that each new FURUNO product is the result of quality materials and workmanship. The warranty is valid for a period of 2 years (24 months) from the date of the invoice, or the date of commissioning of the product by the installing certified dealer.

2. FURUNO Standard Warranty

The FURUNO standard warranty covers spare parts and labour costs associated with a warranty claim, provided that the product is returned to a FURUNO national distributor by prepaid carrier.

The FURUNO standard warranty includes:

- Repair at a FURUNO national distributor
- All spare parts for the repair
- Cost for economical shipment to customer

3. FURUNO Onboard Warranty

If the product was installed/commissioned and registered by a certified FURUNO dealer, the customer has the right to the onboard warranty.

The FURUNO onboard warranty includes

- Free shipping of the necessary parts
- Labour: Normal working hours only
- Travel time: Up to a maximum of two (2) hours
- Travel distance: Up to a maximum of one hundred and sixty (160) KM by car for the complete journey

4. Warranty Registration

For the Standard Warranty - presentation of product with serial number (8 digits serial number, 1234-5678) is sufficient. Otherwise, the invoice with serial number, name and stamp of the dealer and date of purchase is shown.

For the Onboard Warranty your FURUNO certified dealer will take care of all registrations.

5. Warranty Claims

For the Standard Warranty - simply send the defective product together with the invoice to a FURUNO national distributor. For the Onboard Warranty – contact a FURUNO national distributor or a certified dealer. Give the product's serial number and describe the problem as accurately as possible.

Warranty repairs carried out by companies/persons other than a FURUNO national distributor or a certified dealer is not covered by this warranty.

6. Warranty Limitations

When a claim is made, FURUNO has a right to choose whether to repair the product or replace it.

The FURUNO warranty is only valid if the product was correctly installed and used. Therefore, it is necessary for the customer to comply with the instructions in the handbook. Problems which result from not complying with the instruction manual are not covered by the warranty.

FURUNO is not liable for any damage caused to the vessel by using a FURUNO product.

The following are excluded from this warranty:

- a. Second-hand product
- b. Underwater unit such as transducer and hull unit
- c. Routine maintenance, alignment and calibration services.
- d. Replacement of consumable parts such as fuses, lamps, recording papers, drive belts, cables, protective covers and batteries.
- d. Magnetron and MIC with more than 1000 transmitting hours or older than 12 months, whichever comes first.
- e. Costs associated with the replacement of a transducer (e.g. Crane, docking or diver etc.).
- f. Sea trial, test and evaluation or other demonstrations.
- g. Products repaired or altered by anyone other than the FURUNO national distributor or an authorized dealer.
- h. Products on which the serial number is altered, defaced or removed.
- i. Problems resulting from an accident, negligence, misuse, improper installation, vandalism or water penetration.
- j. Damage resulting from a force majeure or other natural catastrophe or calamity.
- k. Damage from shipping or transit.
- l. Software updates, except when deemed necessary and warrantable by FURUNO.
- m. Overtime, extra labour outside of normal hours such as weekend/holiday, and travel costs above the 160 KM allowance
- n. Operator familiarization and orientation.

FURUNO Electric Company, March 1, 2011

FURUNO Warranty for North America

FURUNO U.S.A., Limited Warranty provides a twenty-four (24) months LABOR and twenty-four (24) months PARTS warranty on products from the date of installation or purchase by the original owner. Products or components that are represented as being waterproof are guaranteed to be waterproof only for, and within the limits, of the warranty period stated above. The warranty start date may not exceed eighteen (18) months from the original date of purchase by dealer from Furuno USA and applies to new equipment installed and operated in accordance with Furuno USA's published instructions.

Magnetrons and Microwave devices will be warranted for a period of 12 months from date of original equipment installation.

Furuno U.S.A., Inc. warrants each new product to be of sound material and workmanship and through its authorized dealer will exchange any parts proven to be defective in material or workmanship under normal use at no charge for a period of 24 months from the date of installation or purchase.

Furuno U.S.A., Inc., through an authorized Furuno dealer will provide labor at no cost to replace defective parts, exclusive of routine maintenance or normal adjustments, for a period of 24 months from installation date provided the work is done by Furuno U.S.A., Inc. or an AUTHORIZED Furuno dealer during normal shop hours and within a radius of 50 miles of the shop location.

A suitable proof of purchase showing date of purchase, or installation certification must be available to Furuno U.S.A., Inc., or its authorized dealer at the time of request for warranty service.

This warranty is valid for installation of products manufactured by Furuno Electric Co. (hereafter FURUNO). Any purchases from brick and mortar or web-based resellers that are imported into other countries by anyone other than a FURUNO certified dealer, agent or subsidiary may not comply with local standards. FURUNO strongly recommends against importing these products from international websites or other resellers, as the imported product may not work correctly and may interfere with other electronic devices. The imported product may also be in breach of the local laws and mandated technical requirements. Products imported into other countries, as described previously, shall not be eligible for local warranty service.

For products purchased outside of your country please contact the national distributor of Furuno products in the country where purchased.

WARRANTY REGISTRATION AND INFORMATION

To register your product for warranty, as well as see the complete warranty guidelines and limitations, please visit www.furunousa.com and click on "Support". In order to expedite repairs, warranty service on Furuno equipment is provided through its authorized dealer network. If this is not possible or practical, please contact Furuno U.S.A., Inc. to arrange warranty service.

FURUNO U.S.A., INC.
Attention: Service Coordinator
4400 N.W. Pacific Rim Boulevard
Camas, WA 98607-9408
Telephone: (360) 834-9300
FAX: (360) 834-9400

Furuno U.S.A., Inc. is proud to supply you with the highest quality in Marine Electronics. We know you had several choices when making your selection of equipment, and from everyone at Furuno we thank you. Furuno takes great pride in customer service.

Declaration of Conformity



We **FURUNO ELECTRIC CO., LTD.**

(Manufacturer)

9-52 Ashihara-Cho, Nishinomiya City, 662-8580, Hyogo, Japan

(Address)

declare under our sole responsibility that the product

AIS RECEIVER FA-30

(Model name, type number)

is in conformity with the essential requirements as described in Article 10.3 and Annex II of the Directive 1999/5/EC of the European Parliament and of the Council of 9 March 1999 on radio equipment and telecommunications terminal equipment (R&TTE Directive) and satisfies all the technical regulations applicable to the product within this Directive

IEC 60945 Ed.4.0: 2002 EMC related items
IEC 60950-1 Ed.2.0: 2005 Safety related items
IEC 60950-1 Ed.2.0 A1: 2009 Safety related items
IEC 62287-1 Ed.1.0: 2006 Spurious related items
IEC 61993-2 Ed.1.0: 2001 Spurious related items

(title and/or number and date of issue of the standard(s) or other normative document(s))

For assessment, see

- EMC and Spurious Test Report FLI 12-07-008, March 23, 2007 prepared by FURUNO Labotech International Co., LTD.
- Safety Test Reports FLI 12-07-009, March 19, 2007 and FLI 12-10-055, November 12, 2010 prepared by FURUNO Labotech International Co., LTD.

On behalf of Furuno Electric Co., Ltd.

Takahiko Kusuda
Manager, QMS Secretariat
Quality Assurance Department

Nishinomiya City, Japan
January 11, 2011

(Place and date of issue)

(name and signature or equivalent marking of authorized person)