

# **FURUNO**

## **OPERATOR'S MANUAL**

*MARINE RADAR*

Model **MODEL 1623**

---

# IMPORTANT NOTICES

---

## General

- This manual has been authored with simplified grammar, to meet the needs of international users.
- The operator of this equipment must read and follow the descriptions in this manual. Wrong operation or maintenance can void the warranty or cause injury.
- Do not copy any part of this manual without written permission from FURUNO.
- If this manual is lost or worn, contact your dealer about replacement.
- The contents of this manual and equipment specifications can change without notice.
- The example screens (or illustrations) shown in this manual can be different from the screens you see on your display. The screens you see depend on your system configuration and equipment settings.
- Save this manual for future reference.
- Any modification of the equipment (including software) by persons not authorized by FURUNO will void the warranty.
- The following concern acts as our importer in Europe, as defined in DECISION No 768/2008/EC.
  - Name: FURUNO EUROPE B.V.
  - Address: Siriusstraat 86, 5015 BT, Tilburg, The Netherlands
- All brand and product names are trademarks, registered trademarks or service marks of their respective holders.

## How to discard this product

Discard this product according to local regulations for the disposal of industrial waste. For disposal in the USA, see the homepage of the Electronics Industries Alliance (<http://www.eiae.org/>) for the correct method of disposal.

## How to discard a used battery

Some FURUNO products have a battery(ies). To see if your product has a battery, see the chapter on Maintenance. Follow the instructions below if a battery is used. Tape the + and - terminals of battery before disposal to prevent fire, heat generation caused by short circuit.

### In the European Union

The crossed-out trash can symbol indicates that all types of batteries must not be discarded in standard trash, or at a trash site. Take the used batteries to a battery collection site according to your national legislation and the Batteries Directive 2006/66/EU.

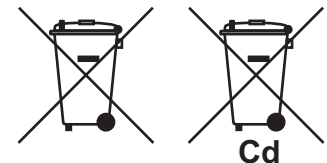

### In the USA

The Mobius loop symbol (three chasing arrows) indicates that Ni-Cd and lead-acid rechargeable batteries must be recycled. Take the used batteries to a battery collection site according to local laws.

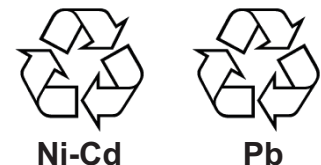

### In the other countries

There are no international standards for the battery recycle symbol. The number of symbols can increase when the other countries make their own recycling symbols in the future.



# SAFETY INSTRUCTIONS

## Safety Instructions for the Operator

## Safety Instructions for the Installer

### **WARNING**



**ELECTRICAL SHOCK HAZARD**  
Do not open the equipment.

Only qualified personnel should work inside the equipment.



**Wear a safety belt and hard hat when working on the antenna unit.**

Serious injury or death can result if someone falls from the radar antenna mast.



The radar antenna emits electromagnetic radio frequency (RF) energy which can be harmful, particularly to your eyes. Never look directly into the antenna aperture from a close distance while the radar is in operation or expose yourself to the transmitting antenna at a close distance.

Distances at which RF radiation levels of 100 and 10 W/m<sup>2</sup> exist are given in the table below.

100 W/m <sup>2</sup>	10 W/m <sup>2</sup>
Nil	0.7 m

**Do not disassemble or modify the equipment.**

Fire, electrical shock or serious injury can result.

**Turn off the power immediately if water leaks into the equipment or the equipment is emitting smoke or fire.**

Continued use of the equipment can cause fire or electrical shock.

### **WARNING LABEL**

**A warning label is attached to the equipment. Do not remove the label. If the label is missing or damaged, contact a FURUNO agent or dealer about replacement.**

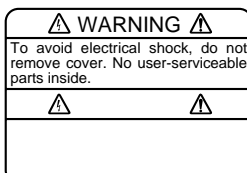

Name: Warning Label (1)  
Type: 86-003-1011-2  
Code No.: 100-236-232-10

### **WARNING**



**ELECTRICAL SHOCK HAZARD**  
Do not open the equipment unless totally familiar with electrical circuits and service manual.

Only qualified personnel should work inside the equipment.



**Wear a safety belt and hard hat when working on the antenna unit.**

Serious injury or death can result if someone falls from the radar antenna mast.

**Construct a suitable service platform from which to install the antenna unit.**

Serious injury or death can result if someone falls from the radar antenna mast.

**Be sure that the power supply is compatible with the voltage rating of the equipment.**

Connection of an incorrect power supply can cause fire or damage the equipment.

**Use only the specified power cable.**

Fire or damage to the equipment can result if a different cable is used.

### **CAUTION**

**Observe the following compass safe distances to prevent interference to a magnetic compass:**

	Standard compass	Steering compass
Display unit	0.50 m	0.30 m
Antenna unit	1.25 m	0.95 m

**Use the proper fuse.**

Use of a wrong fuse can damage the equipment and void the warranty.

# TABLE OF CONTENTS

---

<b>FOREWORD</b> .....	<b>iv</b>		
<b>SYSTEM CONFIGURATION</b> .....	<b>v</b>		
<b>EQUIPMENT LISTS</b> .....	<b>vi</b>		
<b>1. OPERATION</b> .....	<b>1</b>		
1.1 Controls .....	1		
1.2 Indications .....	2		
1.3 Turning Power On/Off .....	3		
1.4 Transmitting, Standby .....	3		
1.5 Adjusting Display Contrast, Brilliance .	4		
1.6 Choosing the Range .....	4		
1.7 Receiver Sensitivity .....	4		
1.8 Suppressing Sea Clutter .....	5		
1.9 Suppressing Rain Clutter .....	6		
1.10 Measuring the Range .....	6		
1.11 Measuring the Bearing .....	7		
1.12 Shifting the Display .....	7		
1.13 Zoom .....	8		
1.14 User Menu Overview .....	8		
1.15 Heading Line .....	9		
1.16 Interference Rejector .....	9		
1.17 Noise Rejector .....	10		
1.18 Echo Trail, Trail Brilliance .....	10		
1.19 Echo Stretch .....	10		
1.20 Guard Alarm .....	11		
1.21 Watchman .....	12		
1.22 Suppressing Long-range Rain Clutter .....	12		
1.23 PROG Key .....	13		
1.24 Outputting Target Position to a Plotter .....	13		
1.25 Turning Navigation Data On/Off .....	14		
1.26 Setting up Nav Data Displays .....	14		
1.27 System Menu .....	16		
<b>2. MAINTENANCE, TROUBLESHOOTING</b> .....	<b>18</b>		
2.1 Maintenance .....	18		
2.2 Replacing the Fuse .....	19		
2.3 Troubleshooting .....	19		
2.4 Diagnostics .....	20		
2.5 Test Pattern .....	21		
2.6 Clearing the Memory .....	21		
2.7 Replacing the Magnetron .....	21		
2.8 Replacing the Synchro Belt .....	21		
<b>3. INSTALLATION</b> .....	<b>22</b>		
3.1 Antenna Unit Installation .....	22		
3.2 Display Unit Installation .....	25		
3.3 Wiring .....	26		
3.4 Adjustments .....	27		
3.5 Magnetron Heater Voltage .....	29		
<b>MENU TREE</b> .....	<b>MN-1</b>		
<b>SPECIFICATIONS</b> .....	<b>SP-1</b>		
<b>PACKING LIST</b> .....	<b>A-1</b>		
<b>OUTLINE DRAWINGS</b> .....	<b>D-1</b>		
<b>INTERCONNECTON DIAGRAM</b> .....	<b>S-1</b>		

# FOREWORD

---

## A Word to the Owner of the MODEL 1623

Congratulations on your choice of the FURUNO MODEL 1623 Marine Radar.

Since 1948, FURUNO Electric Company has enjoyed an enviable reputation for innovative and dependable marine electronics equipment. This dedication to excellence is furthered by our extensive global network of agents and dealers.

Your radar is designed and constructed to meet the rigorous demands of the marine environment. However, no machine can perform its intended function unless installed, operated and maintained properly. Please carefully read and follow the recommended procedures for installation, operation, and maintenance.

We would appreciate hearing from you, the end-user, about whether we are achieving our purposes.

Thank you for considering and purchasing FURUNO equipment.

## COMPLIANCE WITH R&TTE DIRECTIVE 1999/5/EC

This radar complies with the R&TTE Directive 1999/5/EC. In accordance with Article 6-3 of this directive, FURUNO intends to put this radar on the market of the following countries in EU as well other markets.

Austria, Belgium, Cyprus, Denmark, Estonia, Finland, France, Germany, Greece, Hungary, Ireland, Italy, Latvia, Lithuania, Malta, Poland, Portugal, Slovenia, Spain, Sweden, The Netherlands, United Kingdom, Iceland, Norway

## Features

Your radar has a large variety of functions, all contained in a rugged plastic case. All controls respond immediately to the operator's command and each time a key is pressed the corresponding change can be seen on the screen.

The main features of the MODEL 1623 are

- Daylight viewing radar specially designed for small craft and sailing yachts.
- Traditional FURUNO reliability and quality in a compact, light-weight and low-cost radar.
- Compact and light-weight radome antenna with precision 38 cm center-fed radiator.
- High definition 6-inch monochrome LCD display.
- Automatic control of sensitivity (gain), tuning and A/C SEA for simplified operation.
- Targets can be displayed in grey tones on a white background or vice versa, for optimal viewing under any lighting conditions.
- On-screen alphanumeric readout of all operational information.
- User programmable nav data displays.
- [PROG] key provides menu shortcut.
- Standard features include Display Shift, EBL, Echo Stretch, Echo Trail, Guard Alarm, Interference Rejector, VRM, Zoom.
- Guard zone watches for targets entering (or exiting) a guard zone.
- Operates on 12 or 24 V DC power.

## Program No.

0359246-03.\*\* (\*\* denotes minor modifications.)

## Disclosure of Information about China RoHS

With regards to China RoHS information for our products, please refer to our website ([www.furuno.com](http://www.furuno.com)).

# SYSTEM CONFIGURATION

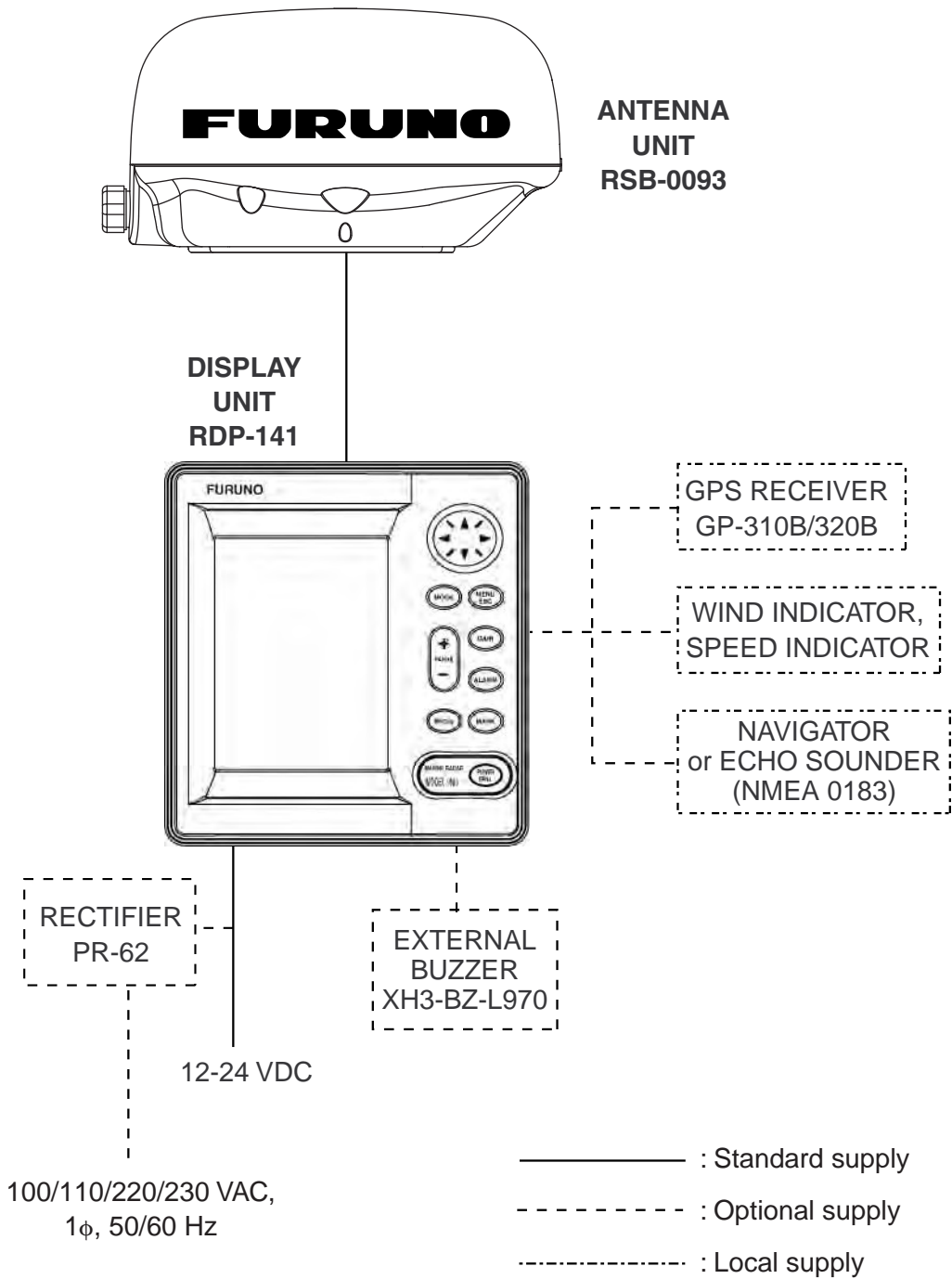

# EQUIPMENT LISTS

## Standard supply

Name	Type	Code No.	Qty	Remarks
Antenna Unit	RSB-0093	—	1	
Display Unit	RDP-141	—	1	
Installation Materials*	CP03-25301	008-442-280	1 set	For antenna unit, including EMI core
	CP03-24910	000-080-231	1 set	Antenna cable (10 m)
	CP03-24920	000-080-232		Antenna cable (15 m)
	CP03-24930	000-080-233		Antenna cable (20 m)
	CP03-25101	008-441-250	1 set	For display unit, including tapping screws for mounting hanger
Spare Parts*	SP03-14301	008-442-270	1 set	Fuse

\*: See packing list at end of manual.

## Option

Name	Type	Code No.	Qty	Remarks
Buzzer Assy.	XH3-BZ-L970	000-146-422	1	With connector, 0.9 m
Cable Assy.	MJ-A7SPF0007-050	000-144-418	1	Connector at one end, 5 m, for NMEA
Cable Assy.	MJ-A15A7F0004-005	000-145-690	1	For NMEA, 0.5 m, connector at both ends, (7P-7P/6P)
Cable Assy.	A15A7F0005-020	000-145-691	1	7P-7P, for NMEA, 2 m
Cable Assy.	MJ-A10SPF0003-300	000-130-034	1	Antenna cable, 30 m, for 24 VDC power
Radome Mounting Bracket	OP03-93	008-445-080	1	For mounting antenna unit on sailboats
Rectifier	PR-62	000-013-484	1	100 VAC
	PR-62	000-013-485		115 VAC
	PR-62	000-013-486		220 VAC
	PR-62	000-013-487		230 VAC

# 1. OPERATION

## 1.1 Controls

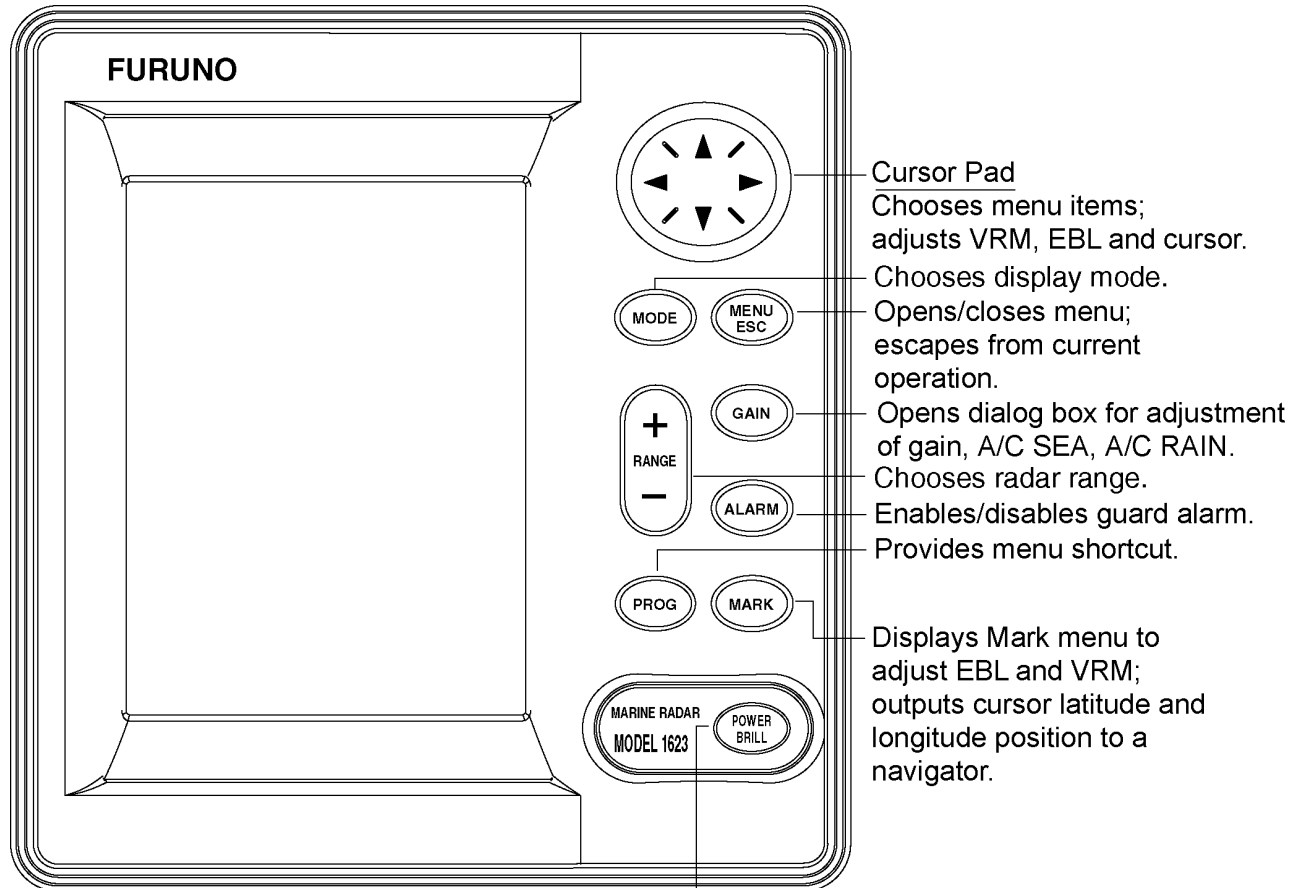

**Short press:** Turns power on.  
**Long press:** Turns power off.  
**Momentary press:** Opens dialog box for (power turned on) adjustment of display contrast and brilliance and mode selection.

*Display unit*

### How to remove the hard cover

Place your thumbs at the center of the cover, and then lift the cover while pressing it with your thumbs.

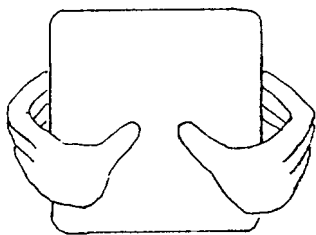



## 1.2 Indications

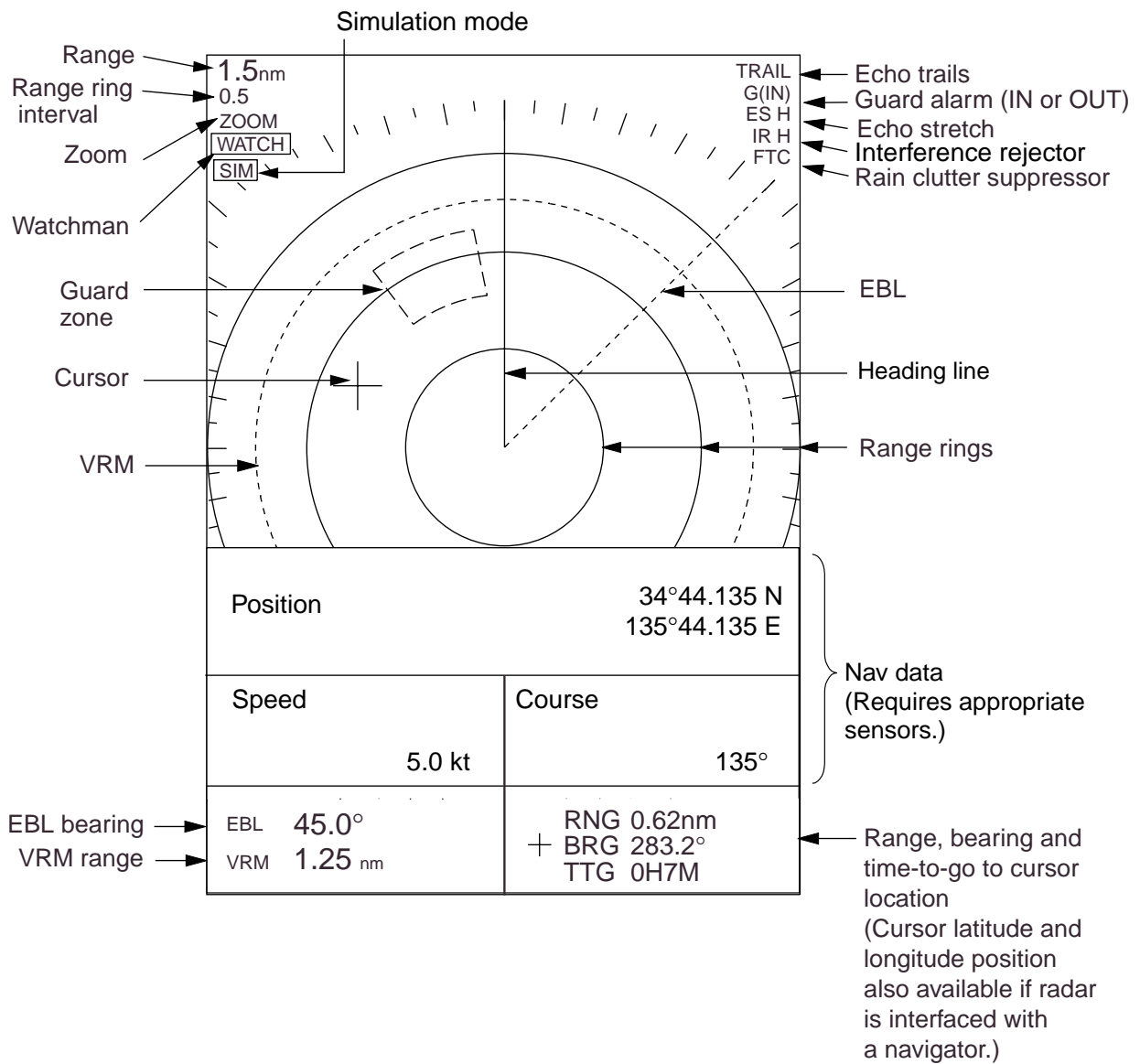

### About the LCD

This high quality LCD displays better than 99.9% of its picture elements. The remaining 0.01% may drop out or light, however this is not an indication of malfunction; it is characteristic of the LCD.

## 1. OPERATION

### 1.3 Turning Power On/Off

Press the [POWER/BRILL] key to turn on the power. The unit beeps, the startup screen appears, and then the equipment checks the ROM and RAM for proper operation and displays program number. The ROM and RAM check shows OK or NG (No Good). If NG appears, try to press any key except the [POWER/BRILL] key to start operation. However, the equipment may not work properly. Contact your dealer for advice.



XX.XX = Program version no.

#### *Startup screen*

After the completion of the startup test, a timer displays the time remaining for warm up of the magnetron (the device which transmits radar pulses), counting down from 1:00 to 0:00.

To turn off the power, press and hold down the [POWER/BRILL] key until the screen goes blank. The time remaining until power is turned off is counted down on the screen.

**Note:** In a cold environment the screen appears "foggy" when the power is turned on but is soon restored to normal condition.

### 1.4 Transmitting, Standby

After the power is turned on and the magnetron has warmed up, "ST-BY" (Standby) appears, indicating the radar is ready to transmit radar pulses.

To toggle between transmit and standby, do the following:

1. Press the [POWER/BRILL] key momentarily to show the brilliance/contrast adjustment window.

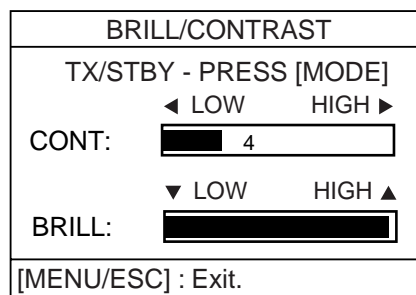

#### *Brilliance/contrast adjustment window*

2. Press the [MODE] key to go to standby and transmit alternately.  
**Note:** If you attempt to transmit before "ST-BY" appears, the buzzer sounds and the radar does not transmit pulses. Wait until "ST-BY" appears.
3. Press the [MENU/ESC] key to close the window.

When radar pulses are transmitted the radar receive is automatically tuned. Echoes appear in four levels of digitized video according to echo strength. When a target is beneath a marker (VRM, EBL, heading line, range ring) the part of the marker where the target lies is displayed in reverse video.

**Note:** This can be done with the above-mentioned procedure or the PROG key if it is so programmed. For detail, see 1.26 "PROG Key".

## 1.5 Adjusting Display Contrast, Brilliance

1. Press the [POWER/BRILL] key momentarily to show the brilliance/contrast adjustment window.

BRILL/CONTRAST	
TX/STBY - PRESS [MODE]	
◀ LOW HIGH ▶	
CONT:	<input type="text" value="4"/>
▼ LOW HIGH ▲	
BRILL:	<input type="text" value=""/>
[MENU/ESC] : Exit.	

*Brilliance/contrast adjustment window*

2. Press ◀ or ▶ to adjust contrast.
3. Press ▲ or ▼ to adjust brilliance.
4. Press the [MENU/ESC] key to escape.

**Note 1:** Windows other than menu windows are erased when there is no operation within about 10 seconds.

**Note 2:** When the power is reapplied after turning off the equipment with minimum brilliance, the radar starts up with minimum brilliance, after the startup screen appears. Adjust the brilliance as necessary.

## 1.6 Choosing the Range

The range selected automatically determines the range ring interval, the number of range rings and pulse repetition rate.

Press the [RANGE+] or [RANGE-] key to select a range. The range and range ring interval appear at the top left corner on the screen.

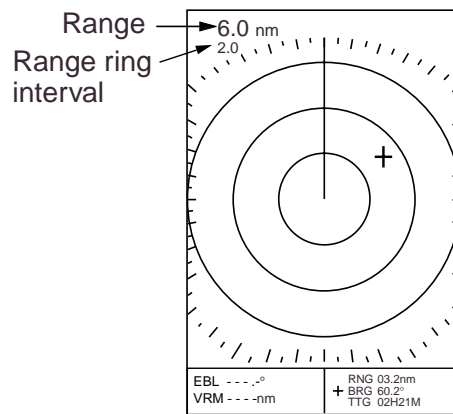

*Location of range and range ring interval indications*

## 1.7 Receiver Sensitivity

The [GAIN] key adjusts the sensitivity (gain) of the receiver. It works in precisely the same manner as the volume control of a broadcast receiver, amplifying the signals received.

The sensitivity is adjusted automatically according to sea conditions, and you may also further adjust it manually to fine tune. The proper setting is such that the background noise is just visible on the screen.

If you set up for too little sensitivity, weak echoes may be missed. On the other hand excessive sensitivity yields too much background noise; weak targets may be missed because of the poor contrast between desired echoes and the background noise on the display.

1. Press the [GAIN] key consecutively until the display shown below appears.

GAIN	
AUTO	: MODERATE
<b>MANU</b>	<input type="text" value="20"/>
[GAIN] : A/C SEA MENU	
[MENU/ESC] : Exit.	

*Gain adjustment window*

## 1. OPERATION

2. Press ▲ or ▼ to choose AUTO or MANU as appropriate.

### Automatic gain adjustment

- a) Press ► to open the automatic gain options window.



*Automatic gain options*

- b) Press ▲ or ▼ to choose ROUGH, MODERATE or CALM depending on sea conditions.
- c) Press ◀ to close the window.

### Manual gain adjustment

While observing the screen and the gain tuning bar, press ◀ or ► to set the gain. The setting range is 0-100.

3. Press the [MENU/ESC] key to finish.

## 1.8 Suppressing Sea Clutter

In rough weather, returns from the sea surface, called sea clutter, are received over several miles around own ship and mask nearby targets. This situation can be improved by properly suppressing the sea clutter with the A/C SEA control.

In most cases suppress the clutter until it has disappeared to leeward, but a little is still visible windward. If the setting is too low, targets will be hidden in the clutter, while if it is set too high, both sea clutter and targets will disappear from the display.

A common mistake is too over-suppress sea clutter so that it is completely removed. You can see how dangerous this can be by setting up for maximum A/C SEA: A dark zone will be created near the center of the screen, causing a loss of close-in targets. This dark zone is even more dangerous if the sensitivity has not been properly adjusted.

Always leave a little sea clutter visible on the Screen, first adjusting automatically and then fine tuning with the manual control as necessary.

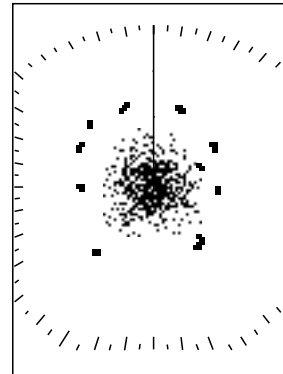

*Sea clutter at screen center*

1. Press the [GAIN] key consecutively until the display shown below appears.

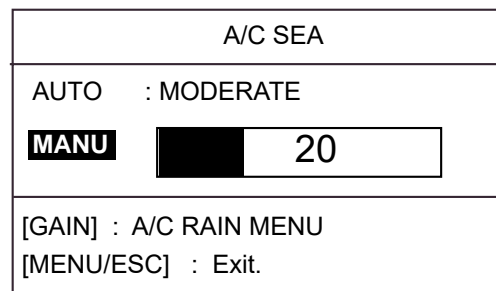

*A/C SEA adjustment window*

2. Press ▲ or ▼ to choose AUTO or MANU as appropriate.

### Automatic A/C SEA adjustment

- a) Press ► to open the automatic A/C SEA options window.

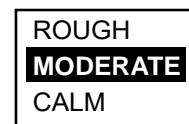

*A/C SEA options*

- b) Press ▲ or ▼ to choose ROUGH, MODERATE or CALM depending on sea conditions.
- c) Press ◀ to close the window.

### Manual A/C SEA adjustment

While observing the screen and the A/C SEA tuning bar, press ◀ or ▶ to set the A/C SEA. The setting range is 0-100.

4. Press the [MENU/ESC] key to finish.

## 1.9 Suppressing Rain Clutter

The vertical beamwidth of the antenna is designed to see surface targets even when the ship is rolling. However, by this design the antenna will also pick up rain clutter (rain, snow, or hail) in the same manner as normal targets. The illustration below shows the appearance of rain clutter on the display.

The A/C RAIN control adjusts the receiver sensitivity as the A/C SEA control does but rather in a longer time period (longer range). The higher the setting the greater the anti-clutter effect.

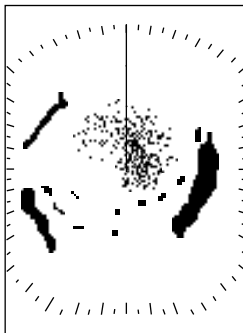

*Rain clutter at screen center*

1. Press the [GAIN] key consecutively until the display shown below appears.

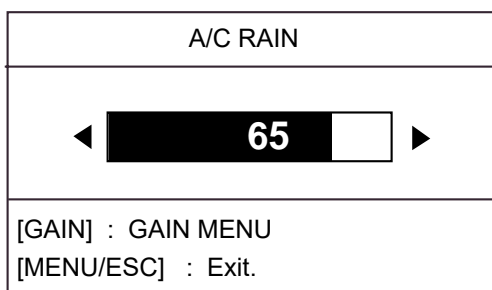

*A/C RAIN adjustment window*

2. While observing the screen and the A/C RAIN tuning bar, press ◀ or ▶ to adjust the A/C RAIN. The setting range is 0-100.
3. Press the [MENU/ESC] key to finish.

## 1.10 Measuring the Range

The bearing to a target can be measured by the range rings, by the cursor and by the VRM (Variable Range Marker).

### Measuring range by the cursor

Operate the cursor pad to place the cursor on the inside edge of the target. Read the range to the cursor at the bottom right corner of the display.

### Measuring range by the range rings

Count the number of rings between the center of the display and the target. Check the range ring interval and judge the distance of the echo from the inner edge of the nearest ring.

**Note:** The range rings can be turned on or off with RINGS on page 1 of the System menu.

### Measuring range by the VRM

1. Press the [MARK] key to show the Mark menu.

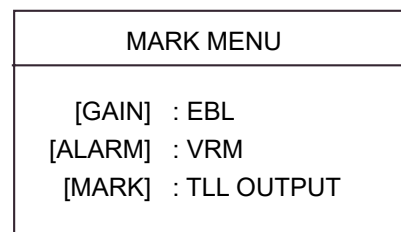

*Mark menu*

2. Press the [ALARM] key to display the VRM, which is a dashed ring to distinguish it from the range rings.
3. Operate the cursor pad to place the VRM on the inside edge of the target.
4. Check the VRM readout at the bottom left corner on the screen to find the range to the target.

To anchor the VRM on the screen, press the [MENU/ESC] key. To erase the VRM, press the [ALARM] key twice with the MARK MENU displayed.

# 1. OPERATION

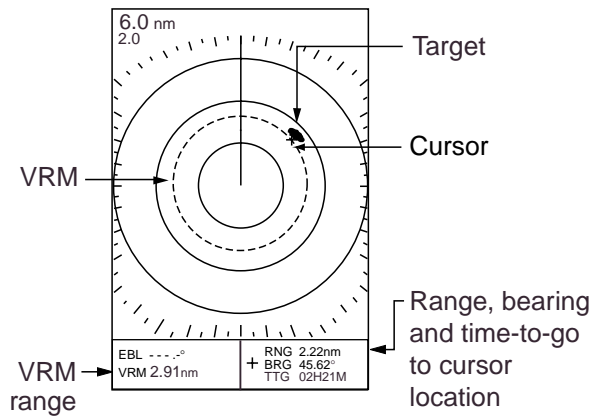

*How to measure the range with the VRM and cursor*

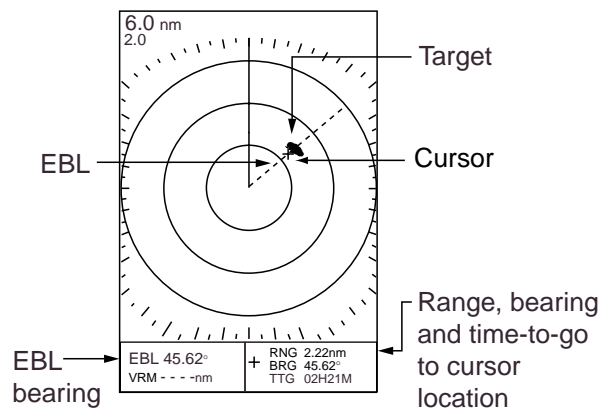

*Measuring range by the EBL and cursor*

## 1.11 Measuring the Bearing

The bearing to a target can be measured with the cursor and the EBL (Electronic Bearing Line).

### Measuring bearing with the cursor

Operate the cursor pad to place the cursor on the inside edge of the target. Read the bearing to the target at the bottom right corner.

### Measuring bearing with the EBL

1. Press the [MARK] key to show the Mark menu.

MARK MENU	
[GAIN]	: EBL
[ALARM]	: VRM
[MARK]	: TLL OUTPUT

*Mark menu*

2. Press the [GAIN] key to show the EBL, which is a dashed line to distinguish it from the heading line.
3. Operate the cursor pad to bisect the target with the EBL.
4. Check the EBL readout at the bottom left corner on the screen to find the bearing to the target.

To anchor the EBL, press the [MENU/ESC] key. To erase the EBL, press the [GAIN] key twice with the MARK MENU displayed.

## 1.12 Shifting the Display

Own ship position, or sweep origin, can be displaced manually or automatically to expand the view field without switching to a longer range. The default shift method is manual.

If shift is activated when nav data is displayed, the nav data is automatically erased.

1. Use the cursor pad to place the cursor where you want to shift own ship position.
2. Press the [MODE] key to show the Display Mode menu.

DISPLAY MODE	
▲ SHIFT (MANUAL)*	<b>NORMAL</b>
▼ ZOOM	
NAV DISP	◀ <b>OFF</b> ON ▶
[MENU/ESC] : Exit	

*Display mode menu*

3. Press ▲ to choose SHIFT (MANUAL).
 

**Note:** If SHIFT (AUTO) is shown, open the System menu and set SHIFT MODE to MANUAL. For further details, see SHIFT MODE on page 17.
4. Press the [MENU/ESC] key to close the menu.

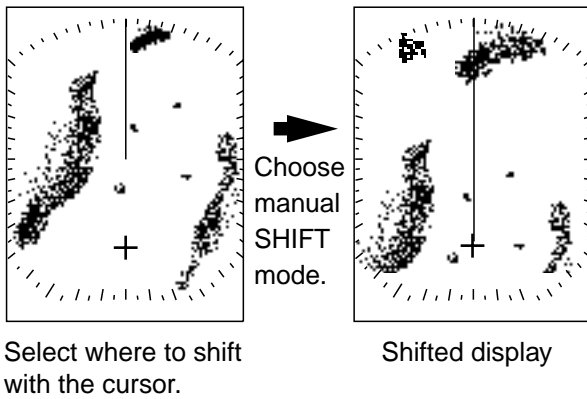

*How the manual shift works*

To cancel the shifted display, open the Display Mode menu, choose NORMAL and then press the [MENU/ESC] key.

### 1.13 Zoom

The zoom feature allows you to double the size of a selected area.

If zoom is activated when nav data is displayed, the nav data is automatically erased.

1. Use the cursor pad to place the cursor where you want to zoom.
2. Press the [MODE] key to show the display mode menu.

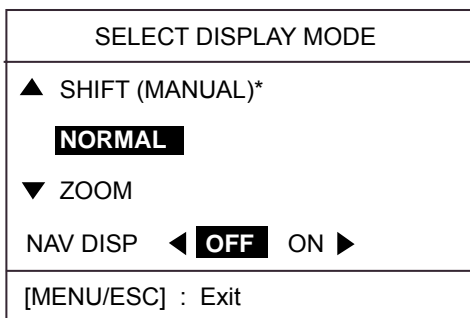

\* AUTO may appear instead of MANUAL depending on shift method selected.

*Display mode menu*

3. Press ▼ to choose ZOOM.
4. Press the [MENU/ESC] key to close the menu. "ZOOM" appears at the top left corner when the zoom feature is turned on.

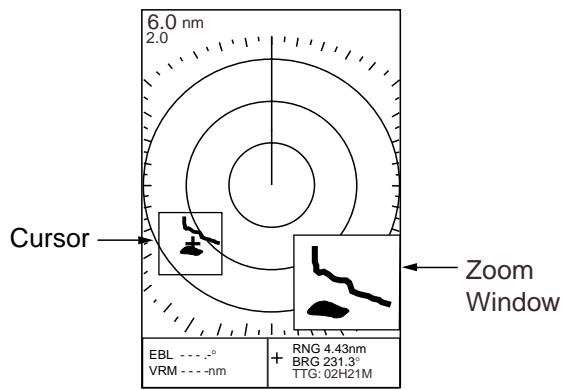

*Zoom display*

To cancel the zoom display, open the Display Mode menu, choose NORMAL and then press the [MENU/ESC] key. To choose new zoom location, return to the NORMAL mode and then repeat the zoom procedure.

### 1.14 User Menu Overview

The User menu, consisting of three pages of menus, contains 10 items which the user may set according to conditions.

1. Press the [MENU] key to open the User menu.

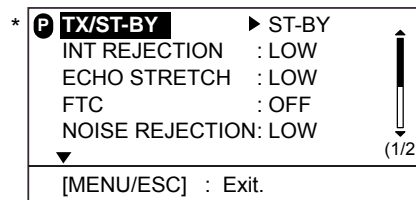

\* = "P" shows current function of PROG key

*User menu, page 1*

2. Use ▲ or ▼ to scroll the menu to display desired item in reverse video.

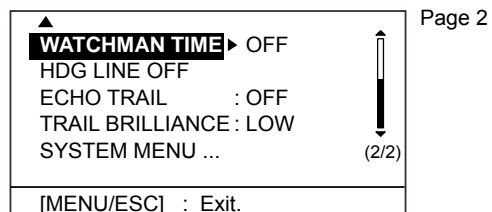

*User menu, pages 2*

## 1. OPERATION

- Press ► to show the options window for the item selected. For example, the illustration below shows the interference rejector options window.

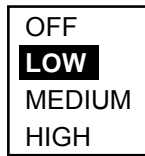

### *Interference rejector options*

- Press ▲ or ▼ to choose option desired.
- Press ◀ to continue menu operation, or press the [MENU/ESC] key to register your selection and close the User menu.

### User menu description

Item	Description
TX/ST-BY	Sets radar in transmit or stand-by status.
INT REJECTION	Rejects radar interference.
ECHO STRETCH	Stretches echoes in range direction or range and bearing direction.
FTC	Reduces rain clutter.
NOISE REJECTION	Rejects noise.
WATCHMAN TIME	Periodically checks for targets in guard zone.
HDG LINE OFF	Temporarily turns the heading line off.
ECHO TRAIL	Shows echo movement in afterglow.
TRAIL BRILLIANCE	Adjusts echo trail brilliance.
SYSTEM MENU	Opens the system menu. For description see paragraph 1.30.

## 1.15 Heading Line

The heading line indicates the ship's heading and it is the solid line which appears at zero degrees on the bearing scale.

To temporarily erase the heading line to look at targets existing dead ahead of own ship, do the following:

- Press the [MENU/ESC] key to open the User menu.
- Press ▲ or ▼ to choose HDG LINE OFF from page 2.
- Press ► to turn the heading line off. The line stays off while ► is pressed.
- Press the [MENU/ESC] key to close the menu.

## 1.16 Interference Rejector

Mutual radar interference may occur in the vicinity of another shipborne radar operating in the same frequency band (9 GHz). It is seen on the screen as a number of bright spikes either in irregular patterns or in the form of usually curved spoke-like dotted lines extending from the center to the edge of the picture. This type of interference can be reduced by activating the interference rejector circuit. "IR" and the rejection level indicator "L," "M" or "H" appear at the top right corner when the interference rejector circuit is on.

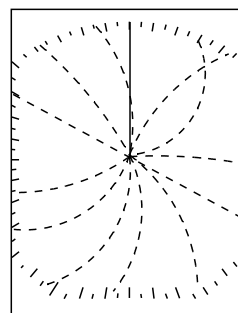

### *Appearance of interference*

Turn off the interference rejector when no interference exists, to avoid missing small targets.

- Press the [MENU/ESC] key to open the User menu.



2. Press ▲ or ▼ to choose INT REJECTION from page 1.
3. Press ► to open the options window.
4. Press ▲ or ▼ to choose OFF, LOW, MEDIUM or HIGH as appropriate.
5. Press the [MENU/ESC] key to finish.

3. Press ► to open the options window.

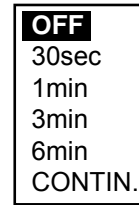

## 1.17 Noise Rejector

The noise rejector suppresses white noise, which appears on the screen as many dots scattered randomly over the display.

1. Press the [MENU/ESC] key to open the User menu.
2. Press ▲ or ▼ to choose NOISE REJECTION from page 1.
3. Press ► to open the options window.
4. Press ▲ or ▼ to choose OFF, LOW or HIGH as appropriate.
5. Press the [MENU/ESC] key to close the menu.

### *Echo trail options*

4. Press ▲ or ▼ to choose appropriate time.
5. Press ◀ to close the options window.
6. Press ▼ to choose TRAIL BRILLIANCE.
7. Press ► to open the options window.
8. Press ▲ or ▼ to choose LOW or HIGH as appropriate.
9. Press the [MENU/ESC] key to close the menu.

## 1.18 Echo Trail, Trail Brilliance

Echo trails are the afterglow of target echoes that represent their movements relative to own ship. They are useful for monitoring target movement.

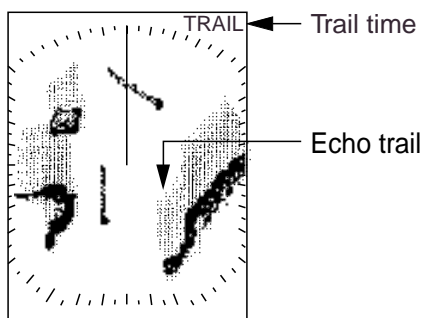

### *Echo trails*

1. Press the [MENU/ESC] key to open the User menu.
2. Press ▲ or ▼ to choose ECHO TRAIL from page 2.

## 1.19 Echo Stretch

On long ranges target echoes tend to shrink, making them difficult to see. To enhance target video on long ranges, use the echo stretch feature.

1. Press the [MENU/ESC] key to open the User menu.
2. Press ▲ or ▼ to choose ECHO STRETCH from page 1.
3. Press ► to open the options window.
4. Press ▲ or ▼ to choose OFF, LOW or HIGH as appropriate. LOW stretches echoes in the bearing direction; HIGH stretches echoes in the range and bearing directions. The display shows "ES L" or "ES H" at the top right corner depending on your selection.
5. Press the [MENU/ESC] key to close the menu.

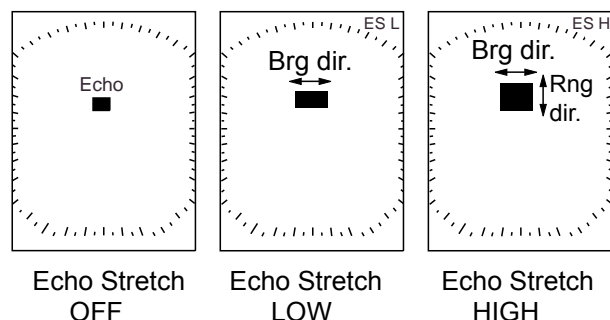

*How echo stretch works*

## 1.20 Guard Alarm

The guard alarm allows the operator to set the desired range and bearing for a guard zone. When ships, islands, landmasses, etc. violate the guard zone, the audio alarm sounds to call your attention. The alarm will sound on targets entering or exiting the zone depending on zone status after the alarm has been set.

<b>NOTICE</b>	
*	The alarm should not be relied upon as the sole means for detecting possible collision situations.
*	A/C SEA, A/C RAIN, FTC and GAIN controls should be properly adjusted to be sure the weak echoes will not be missed by the alarm.

### Setting a guard zone

1. Operate the cursor pad to place the cursor at the top left corner for the zone and then press the [ALARM] key.
2. Operate the cursor pad to place the cursor at the bottom right corner for the zone and then press the [ALARM] key.

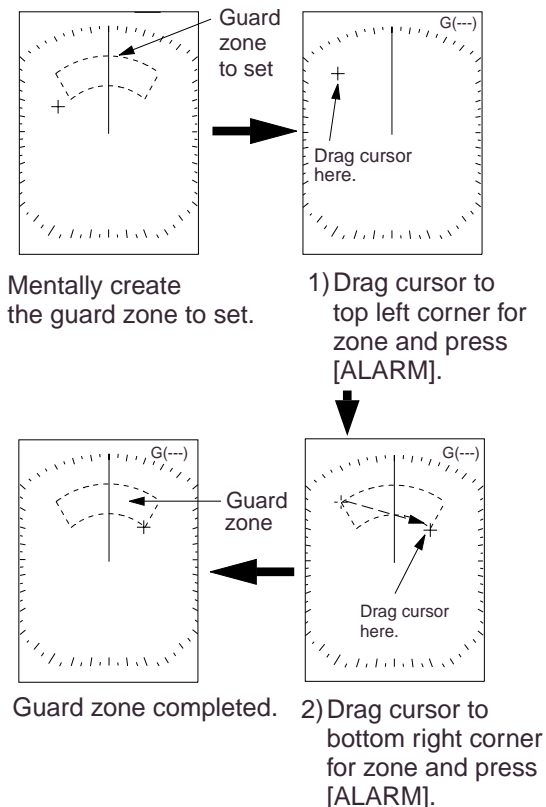

*How to set a guard zone*

### How guard zone type is determined

After the guard zone is set, the system checks for the existence of targets inside the guard zone, which takes about 8 to 12 seconds. When the check is completed, "G(IN)" or "G(OUT)" replaces G(---) at the top right corner.

**G(IN):** When no target exists in the zone, "G(IN)" appears. The audio alarm sounds against targets which enter the guard zone.

**G(OUT):** If there are targets in the guard zone, "G(OUT)" appears. The audio alarm sounds against all targets which exit from the guard zone.

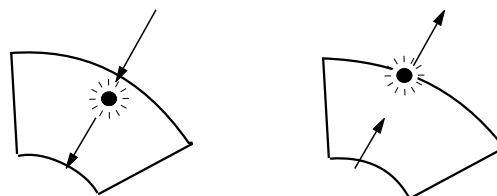

(a) Inward target alarm (b) Outward target alarm

### *Inward and outward alarms*

**Note:** "UP RNG" replaces G(IN) or G(OUT) when the guard zone is not within the range in use. If this happens, change the range to redisplay the guard zone.

### Silencing the audio alarm

When a target violates the guard zone, the target flashes and the audio alarm sounds. You can silence the audio alarm with the [ALARM] key.

### Canceling the guard zone and guard alarm

Press and hold down the [ALARM] key until the guard zone is erased.

## 1.21 Watchman

Watchman transmits the radar for one minute to check if a target has entered or exited the guard zone from the previous transmission. If no change is found, the radar goes into standby for the number of minutes set for the watchman feature. If change is found, the audio alarm sounds, watchman is canceled and the radar transmits. This feature is useful for extending the life of the magnetron.

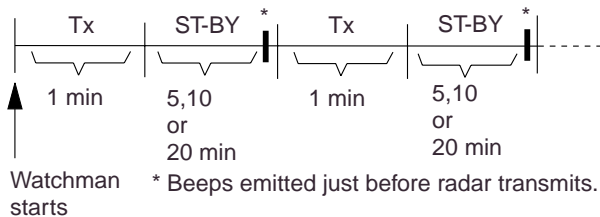

### *How watchman works*

1. Press the [MENU/ESC] key to open the User menu.
2. Press ▲ or ▼ to choose WATCHMAN TIME from page 2.
3. Press ► to open the options window.

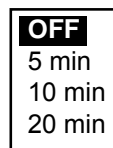

### *Watchman time options*

4. Press ▲ or ▼ to choose appropriate time out, that is, the amount of time the radar waits in standby, among 5, 10 and 20 minutes.
5. Press the [MENU/ESC] key to close the menu.

## 1.22 Suppressing Long-range Rain Clutter

In adverse weather, clouds, rain or snow produce spray-like spurious echoes which impair target detection over a long distance. These echoes can be suppressed by turning on the FTC.

1. Press the [MENU/ESC] key.
2. Press ▲ or ▼ to choose FTC from page 1.
3. Press ► to open the options window.
4. Press ▲ or ▼ to choose OFF or ON as appropriate.
5. Press the [MENU/ESC] key to close the menu.

“FTC” appears at the top right corner when the FTC is active.

## 1. OPERATION

### 1.23 PROG Key

The [PROG] key acts as a menu shortcut key. You may use any User menu item except "SYSTEM MENU."

#### Using the PROG key

1. Press the [PROG] key. The options window corresponding to the item programmed appears. In the example below the echo stretch options window is shown.

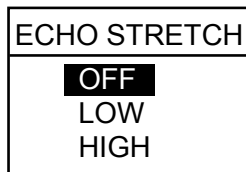

*Echo stretch options window*

2. Press ▲ or ▼ to choose appropriate option.
3. Press the [MENU/ESC] key to close the options window.

#### Programming the PROG key

1. Press the [MENU/ESC] key to open the User menu. "P" marks the current function of the [PROG] key.

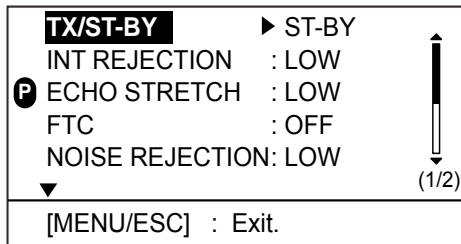

*User menu, page 1*

2. Press ▲ or ▼ to choose the item you wish to use.
3. Press and hold down the [PROG] key (about three seconds) until you hear a beep. The "P" moves to the item selected.
4. Press the [MENU/ESC] key to close the menu.

### 1.24 Outputting Target Position to a Plotter

If the radar is interfaced with a plotter, you can output target position to the plotter, and show that position on the plotter's screen with the target mark (X). This function requires position and heading data.

1. Use the cursor pad to place the cursor on a target.
2. Press the [MARK] key to show the Mark menu.

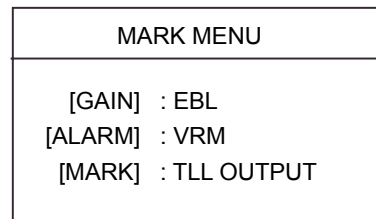

*Mark menu*

3. Press the [MARK] key again to output cursor position.
4. Press the [MENU/ESC] key to close the menu.

## 1.25 Turning Navigation Data On/Off

Navigation data appears on the bottom half of the screen as in the illustration below. You may turn the navigation data display on or off as shown below.

**Note:** When the nav data is turned on with shift or zoom active, zoom or shift is cancelled.

1. Press the [MODE] key.
2. Press ► to choose ON; ◀ to choose OFF.
3. Press the [MENU/ESC] key to close the menu.

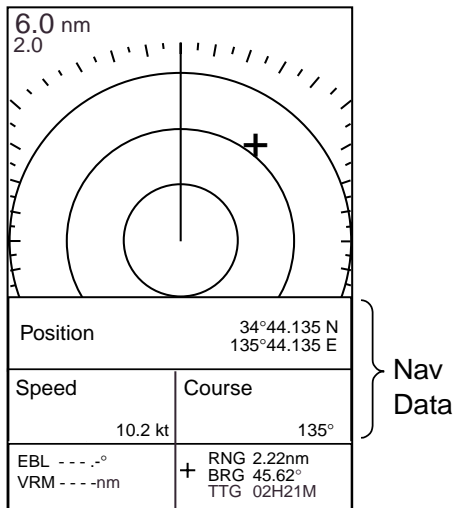

Sample navigation display

## 1.26 Setting up Nav Data Displays

The user may arrange the nav data display as desired. You may display between two and four items and choose the item and the order to display them. For how to choose the number of items to display, see "NAV DATA" on page 16.

1. Turn on the nav data referring to paragraph 1.28.
2. Press the [POWER/BRILL] key momentarily followed by the [MODE] key to go into standby.

3. Press the [MENU/ESC] key to close the window.
4. Press the cursor pad to display the nav data setup window.

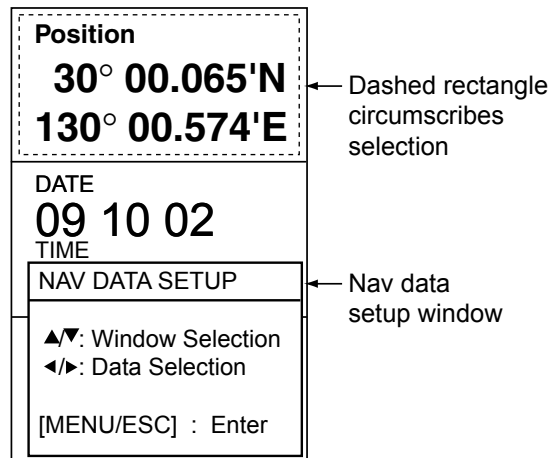

Nav data display with nav data setup window

4. Press ▲ or ▼ to choose the data window to process. The dashed rectangle marks current selection.
5. Press ◀ or ▶ to choose item to display. See the illustration below for the data availability. A description of the nav data displays appears on the next page.

2-item display	3-item display	4-item display
Nav data at stand-by		
(1)	(3)	(6)
(2)	(4)	(7)
	(5)	(8)
		(9)

Nav data on radar display		
(1)	(3)	(6) (7)
(2)	(4) (5)	(8) (9)

Items displayable in (1) - (3): depth, position, course, date, time, range and bearing, trip distance, odometer distance, water temperature, heading, time-to-go to destination waypoint, XTE\*, speed\*, wind speed and direction\*, destination waypoint data\*, compass\*

Items displayable in (4) - (9): depth, position, course, range and bearing, trip distance, odometer distance, water temperature, date, time, speed, heading, air pressure, time-to-go to destination waypoint, XTE, wind speed and direction

\* = Graphic display in standby

### Nav data window and item displayable

5. Press the [MENU/ESC] key to close the nav data setup window.

1. OPERATION

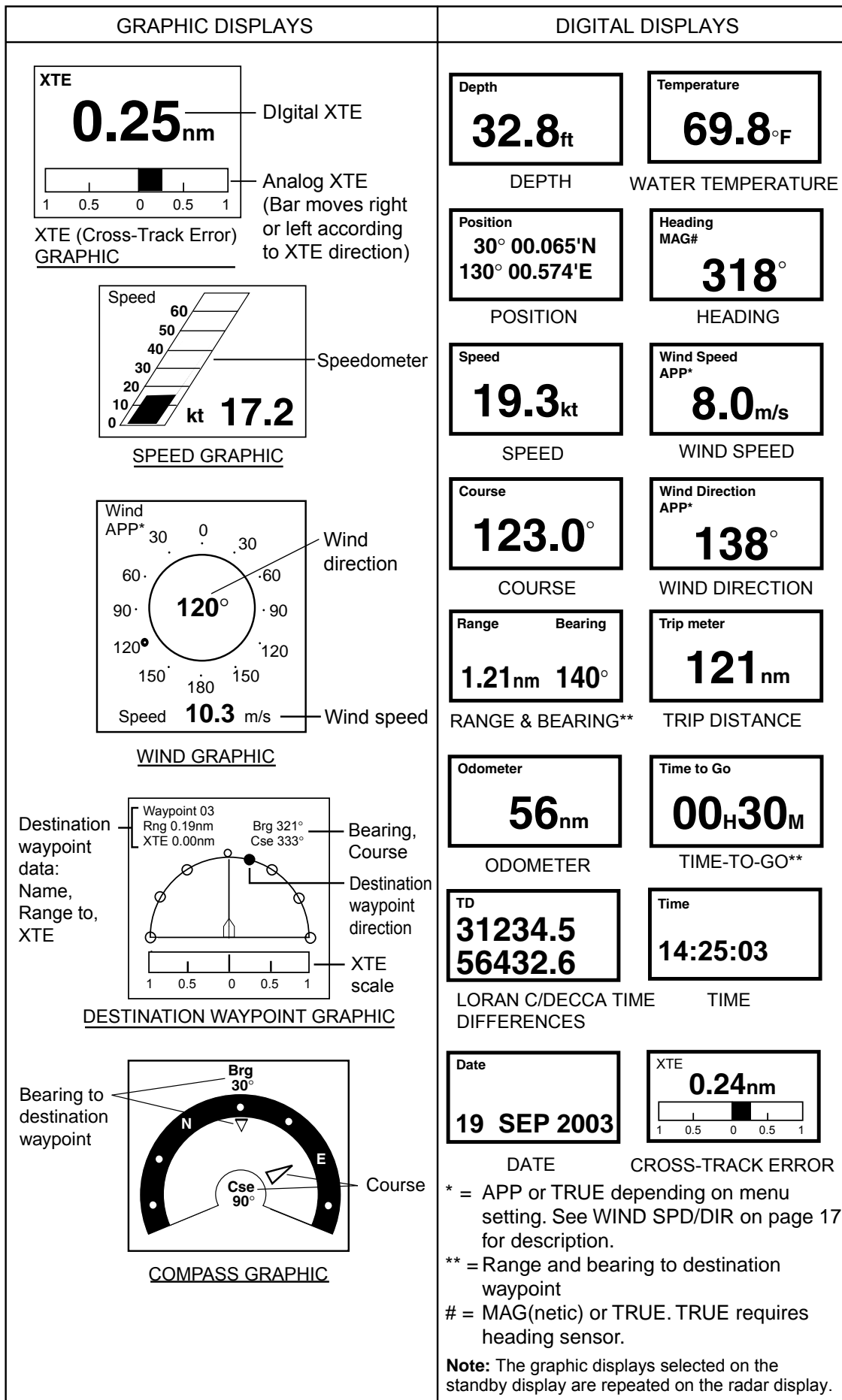

\* = APP or TRUE depending on menu setting. See WIND SPD/DIR on page 17 for description.

\*\* = Range and bearing to destination waypoint

# = MAG(netic) or TRUE. TRUE requires heading sensor.

**Note:** The graphic displays selected on the standby display are repeated on the radar display.

Nav data displays

## 1.27 System Menu

The System menu mainly contains items which once set do not require frequent adjustment. You may display this menu by choosing "SYSTEM MENU" from page 3 of the User menu and then pressing ►.

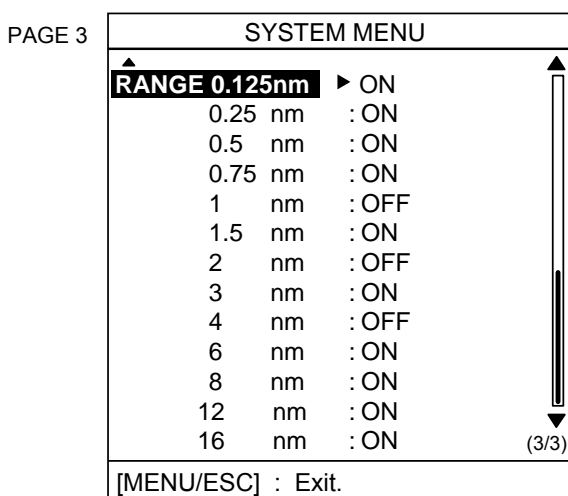
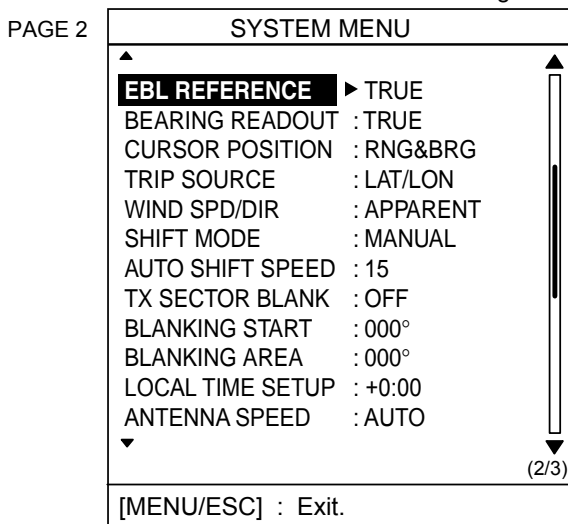
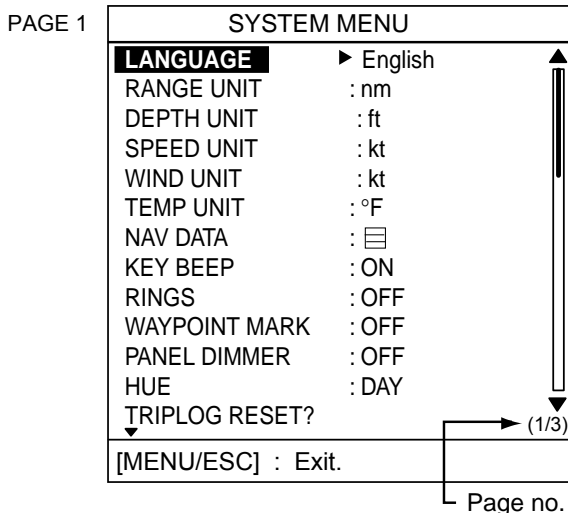

System menu

## System menu description

### Page 1 of system menu

**LANGUAGE:** The system language is available in English, several European languages and Japanese. To change the language, choose language desired, and then press the [MENU/ESC] key.

**RANGE UNIT:** Chooses the unit of range measurement among nautical miles, kilometers and statute miles.

**DEPTH UNIT:** Chooses the unit of depth measurement among meters, feet, fathoms, Hiro (Japanese) and Passi/Braza. Requires depth data.

**SPEED UNIT:** Chooses the unit of speed measurement among knot, mile per hour and kilometer per hour. Requires speed data.

**WIND UNIT:** Chooses the unit of wind measurement among mile per hour, kilometer per hour and meters per second. Requires wind data.

**TEMP UNIT:** Chooses the unit of water temperature measurement from Celsius and Fahrenheit. Requires water temperature data.

**NAV DATA:** Chooses the amount of nav data to display among two, three and four items. Requires appropriate sensors.

**KEY BEEP:** A beep sounds to confirm valid and invalid operation. You can turn this beep on or off.

**RINGS:** Turns the range rings on or off.

**WAYPOINT MARK:** The waypoint mark shows the location a destination waypoint set on a navigator. You can turn this mark on or off. Requires a navigator.

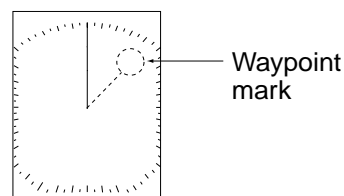

## 1. OPERATION

**PANEL DIMMER:** You may adjust panel backlighting from among OFF, LOW, MEDIUM and HIGH.

**HUE:** The default hue setting (DAY) display is most suitable for daytime viewing. For nighttime viewing you may reverse this arrangement (NIGHT).

**TRIPLOG RESET:** You may reset distance run to zero by choosing YES. Navigator or speed log is required to display distance run.

### Page 2 of system menu

**EBL REFERENCE:** The EBL readout may be chosen from relative (relative to own ship's heading) or true (referenced to the North). Heading data required for true bearing.

**Note:** If no bearing data is input, course data from the GPS navigator is used. In this case ship's speed must be more than two knots.

**BEARING READOUT:** Course indication may be shown in true or magnetic (magnetic compass) degrees. Heading data required for true degrees.

**CURSOR POSITION:** Chooses the information to show for the cursor position: latitude and longitude or range and bearing from own ship. Latitude and longitude position requires a navigator.

**TRIP SOURCE:** Chooses the criteria for calculating distance run: latitude and longitude or speed. Requires navigator or speed log.

**WIND SPD/DIR:** **True** is the speed and direction (in relation to ship's bow) of the wind felt or measured when stationary. **Apparent** is the direction (in relation to ship's bow) and speed of the wind as it appears to those on board, relative to the speed and direction of the boat; combination of the true wind and the wind caused by the boat's movement. Requires wind data.

**SHIFT MODE:** Own ship position, or sweep origin, can be displaced manually or automatically. For automatic displacement, the amount of shift is calculated with ship speed, and the amount is limited to 60% of the range in use. For example, if the "Auto Shift Speed" setting is 15 knots and the ship is running at 10 knots, the amount of shift will be about 40%. The formula for determining shift amount is as below. Requires speed data.

$$\frac{\text{Ship's speed}}{\text{Shift speed setting}} \times 0.6 = \text{Amount of shift(\%)}$$

**AUTO SHIFT SPEED:** Sets the automatic shift maximum speed. The setting range is 1-99.

**TX SECTOR BLANK:** In some installations it may be unavoidable to locate the antenna where an object (mast, etc.) will prevent transmission within its breadth. You should disable transmission within this area by turning on this feature and setting the area with BLANKING START and BLANKING AREA below.

**BLANKING START:** Sets the starting point (000-359°) of the TX sector blanking area.

**BLANKING AREA:** Sets the end point of the TX sector blanking area (000-135°).

**LOCAL TIME SETUP:** Enter time difference between local time and UTC time to use local time. Press ▲ or ▼ to set value.

**ANTENNA SPEED:** Chooses antenna rotation speed from 24 rpm and AUTO. Use AUTO to automatically change the antenna rotation speed (24-41 rpm) according to pulse length\*. Choose "24 rpm" to rotate the antenna at 24 rpm regardless of pulse length.

\* = Short pulse at high rotation speed; long pulse at slow rotation speed.

### Page 3 of system menu

**RANGE:** Chooses the ranges to use.



## 2. MAINTENANCE, TROUBLESHOOTING

**WARNING**

**ELECTRICAL SHOCK HAZARD**  
Do not open the equipment.

Only qualified personnel should work inside the equipment.

**NOTICE**

Do not apply paint, anti-corrosive sealant or contact spray to coating or plastic parts of the equipment.

Those items contain organic solvents that can damage coating and plastic parts, especially plastic connectors.

### 2.1 Maintenance

Regular maintenance is important for good performance. A maintenance program should be established and should at least include the items listed in the table below.

Maintenance program

Period	Item	Check point	Action
3 to 6 months	Fixing bolts for antenna unit	Check for corrosion and if tightly fastened.	Replace corroded bolts. Coat new bolts with anticorrosive sealant.
	Antenna unit cleanliness	Check for foreign material. (Foreign material on the antenna unit can cause a considerable drop in sensitivity.)	Clean the antenna unit with a freshwater-moistened cloth. Alcohol may be used. Do not use commercial cleaners to clean the antenna unit; they can remove paint and markings or deform the equipment.
	Antenna unit cover	Check for cracks. Permanent damage to the unit's circuitry will result if water leaks inside.	If a crack is found, it should be temporarily repaired by using a small amount of sealing compound or adhesive. The unit should then be brought to your dealer for permanent repairs.
	Display unit case, LCD	The LCD will, in time, accumulate a coating of dust which tends to dim the picture.	Wipe the LCD carefully to prevent scratching, using tissue paper and an LCD cleaner. To remove dirt or salt deposits, use an LCD cleaner, wiping slowly with tissue paper so as to dissolve the dirt or salt. Change paper frequently so the salt or dirt will not scratch the LCD. Do not use solvents such as thinner, acetone or benzene for cleaning; they can remove paint and marks or deform the equipment.
6 months to 1 year	Display unit connectors	Check for tight connection and corrosion.	If corroded, ask your dealer about replacement.

## 2.2 Replacing the Fuse

The fuse (5 A) in the power cable protects the equipment against reverse polarity of ship's mains, overcurrent, and equipment fault. If the fuse blows, find the cause before replacing it.

 <b>CAUTION</b>
<p>Use the proper fuse.</p> <p>Use of a wrong fuse may cause serious damage to the equipment and void the warranty.</p>

## 2.3 Troubleshooting

The table below provides simple troubleshooting procedures which the user can follow to restore normal operation. If you cannot restore normal operation contact your dealer for advice.

### Troubleshooting

If...	But...	Then...
you pressed the [POWER/BRILL] key to turn on the radar	nothing appears on the display or display contrast is poor	<ul style="list-style-type: none"> <li>• try adjusting LCD contrast.</li> <li>• battery may have discharged.</li> <li>• check if fuse has blown.</li> </ul>
	the control panel does not light	adjust PANEL DIMMER on the User menu.
the radar has warmed up and you pressed the [MODE] key to transmit	the message "NO HEADING PULSE" or "NO BEARING PULSE" appears	check that the antenna cable is firmly connected.
	neither noise or targets appear (characters and markers do)	<ul style="list-style-type: none"> <li>• try adjusting gain, A/C SEA and A/C RAIN.</li> <li>• check signal cable for damage.</li> </ul>
a key is pressed	nothing happens	key may be faulty. Contact your dealer.
the display freezes		Press the [POWER/BRILL] key about five seconds to turn off the power and then turn it on again.

## 2.4 Diagnostics

If you feel that your unit is not working properly, conduct the appropriate diagnostic test, display unit or antenna unit, to find the possible cause. If you cannot restore normal operation, contact your dealer for advice.

### Display unit

1. Turn on the power while pressing and holding down the [MENU/ESC] key. Continue pressing the [MENU/ESC] key until the Installation menu appears.

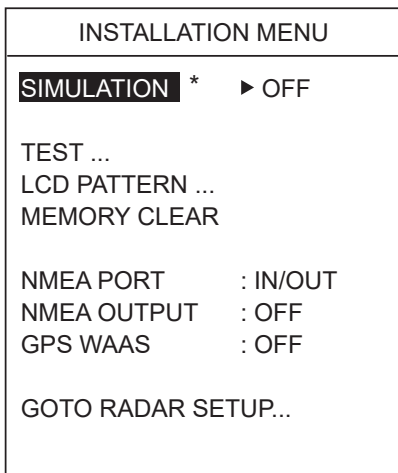

\* The simulation provides internally generated echoes, for use in exhibitions, etc. "SIM" appears at the top left corner when the simulation mode is active.

#### Installation menu

2. Press ▼ to choose TEST.
3. Press ► to start the test. In a few moments the results will appear.

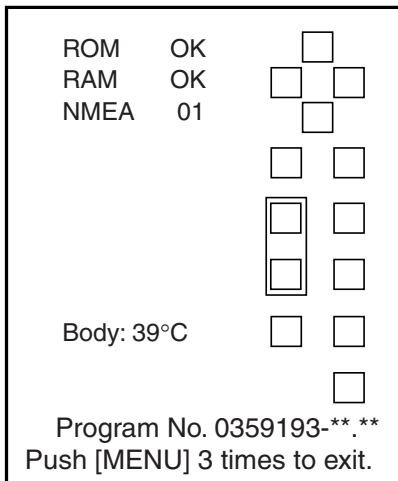

\*\*.\*\* = Program version no.

#### Diagnostic test results

#### Interpreting display unit test results

Item	Results
ROM, RAM	OK: Normal NG: No Good
NMEA	Test connector required to test. Normally, "01" is displayed.
Body	Temperature of display unit

4. The squares at the right side of the test results display are for checking controls. Press each key and the arrows on the cursor pad one by one. A control's corresponding on-screen square "lights" in black if the control is working properly.
5. To return to the Installation menu, press the [MENU/ESC] key three times.
6. To restore normal operation, turn off the power and then turn it on again.

### Antenna unit

1. Display the installation menu as in step 1 in the display unit diagnostic test.
2. Press ▼ to choose GOTO RADAR SETUP and then press ►. Power is automatically reset.
3. Press the [POWER/BRILL] and [MODE] keys to transmit.
4. Press the [MENU/ESC] key. The menu below appears.

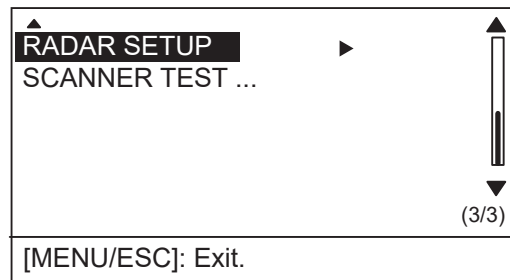

#### Page 3/3 of user menu

5. Press ▼ to choose SCANNER TEST.
6. Press ► to start the test. In a few moments the results will appear, similar to those shown at the top of the next page.
7. To restore normal operation, turn off the power and then turn it on again.

## 2. MAINTENANCE, TROUBLESHOOTING

ANTENNA STATUS	: OK(47)#
HEADING	: OK
BEARING	: OK
	(24.0rpm)*
TUNE	: 
TOTAL ON TIME	: 00000h
TOTAL TX TIME	: 00000h
INPUT NMEA	
<b>RMA</b>	RMB RMC BWC GLL <b>GGA</b>
MTW	VTG VHW <b>XTE</b> VBW DPT
DBK	DBS <b>DBT</b> HDT HDG HDM
BWR	GLC GTD MWV ZDA
[MENU/ESC]: Exit.	

\* 24.0 = Long range  
 31.0 = Medium range } typical value  
 41.0 = Short range  
 # = Status code. For service technician.

### Antenna test results

The antenna unit and heading and bearing signals are checked, and the results shown as OK or NG (No Good). For any NG, contact your dealer for advice. Antenna unit RPM appears below the bearing signal test result.

**Note:** The result of ANTENNA STATUS is shown as “NG (0)” whenever opening the antenna test result screen. For confirming the ANTENNA STATUS correctly, press the [MENU/ESC] key, ► in order to redisplay the test result screen.

The “TUNE” bar shows radar receiver tuning status. Total on time and total TX times appear below the TUNE bar. Data sentences currently input to the radar are highlighted in the “INPUT NMEA” window.

## 2.5 Test Pattern

This feature tests for proper display of tones.

1. Turn on the power while pressing and holding down the [MENU/ESC] key. Continue pressing the [MENU/ESC] key until the Installation menu appears.
2. Press ▼ to choose LCD PATTERN.
3. Press ► to start the test. The entire screen is black.
4. Press the [MENU/ESC] key and the screen turns white.

5. Press the [MENU/ESC] key again and the screen shows a four-tone display.
6. Press the [MENU/ESC] key again to return to the Installation menu.
7. To restore normal operation, turn off the power and then turn it on again.

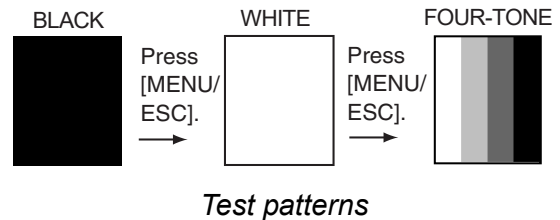

## 2.6 Clearing the Memory

You may want to clear the memory to start afresh with default settings. You can do this as follows:

1. Turn on the power while pressing and holding down the [MENU/ESC] key. Continue pressing the [MENU/ESC] key until the Installation menu appears.
2. Press ▼ to choose MEMORY CLEAR.
3. Press ►.
4. Press ▲ to choose YES.
5. To restore normal operation, turn the power off and then turn it on again.

## 2.7 Replacing the Magnetron

When the magnetron has expired, distant targets cannot be seen on the display. When you feel long range performance has decreased, contact a FURUNO agent or dealer about replacement of the magnetron. (Type: E3588, Code No: 000-142-270)

## 2.8 Replacing the Synchro Belt

When the synchro belt has worn out, the sweep is not synchronized with antenna rotation, which results in an abnormal picture. When you suspect that the synchro belt has worn out, contact a FURUNO agent or dealer about replacement. (Type: 40 S2M 266UG, Code No: 000-808-743)

# 3. INSTALLATION

## 3.1 Antenna Unit Installation

### Mounting considerations

When selecting a mounting location for the antenna unit keep in mind the following points:

- Install the antenna unit on the hardtop, radar arch or on a mast on an appropriate platform. (For sailboats, a mounting bracket is optionally available.) It should be placed where there is a good all-round view with, as far as possible, no part of the ship's superstructure or rigging intercepting the scanning beam. Any obstruction will cause shadow and blind sectors.
- In order to minimize the chance of picking up electrical interference, avoid where possible routing the antenna cable near other electrical equipment onboard. Also, avoid running the cable in parallel with power cables.
- Separate the antenna unit from a magnetic compass by the distances noted below to prevent interference to the magnetic compass:

Standard compass: 1.25 m

Steering compass: 0.95 m

### Mounting on a platform

1. Remove the mounting hardware at the bottom of the antenna unit: four each of hexagon head bolts (M10 x 20), spring washers and flat washers (4 pcs.). Save the mounting hardware to use it to fix the antenna base to the mounting platform.

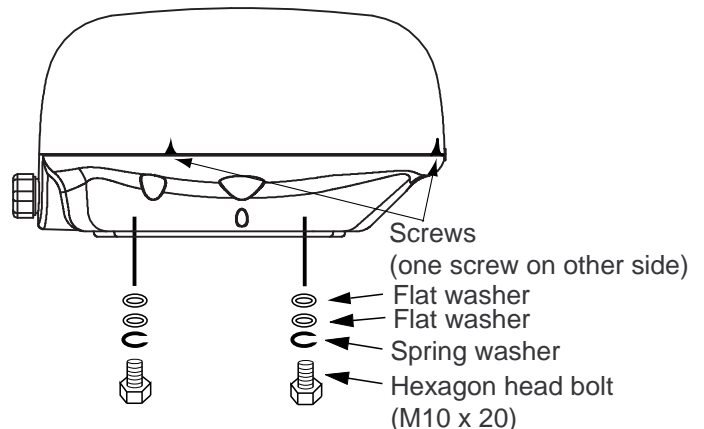

*Antenna unit, showing location of mounting hardware*

2. Construct a wood, steel or aluminum platform on which to fix the antenna. (The thickness of the platform depends on the hex bolts to be used to fix the antenna to the platform. See the illustration on the next page for thickness). Next, position the antenna unit on the platform so the cable entrance faces the stern direction.

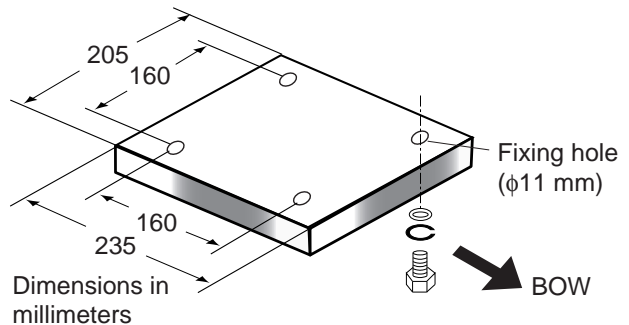

*Dimensions of antenna platform*

**Note 1:** If corrosive material is used for the platform, be sure to take appropriate anti-corrosion measures.

**Note 2:** When drilling holes in the platform, be sure they are parallel with the fore and aft line.

### 3. INSTALLATION

- Using the hexagon head bolts, flat washers and spring washers removed at step 1, fasten the antenna unit to the platform. The torque should be 19.6-24.5 N•m.

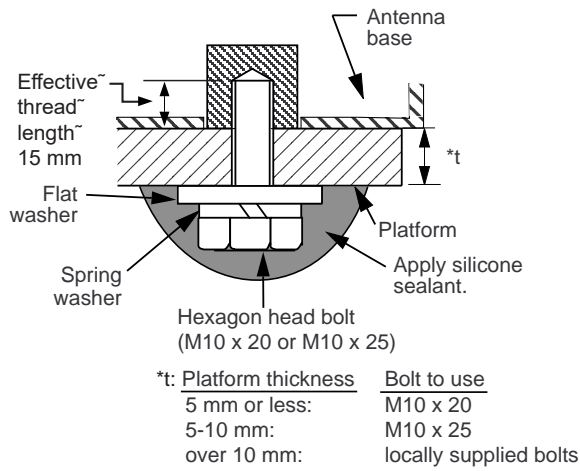

#### How to fasten the antenna unit to the platform

- Unfasten three screws to open the cover. Release the cable of the rotation detector from the cable clamp.

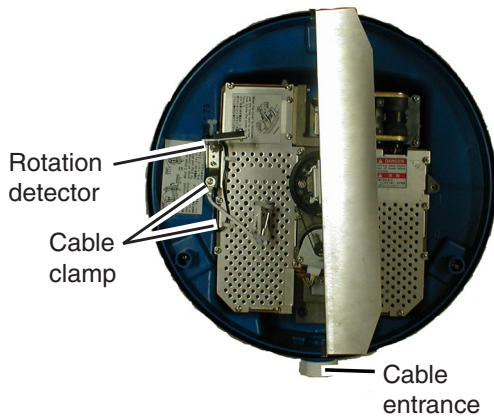

Antenna unit, cover removed, top view

- Referring to the illustration at the top of the next column for location, unfasten 11 screws to dismount the shield plate. Discard the screw circled in the illustration.

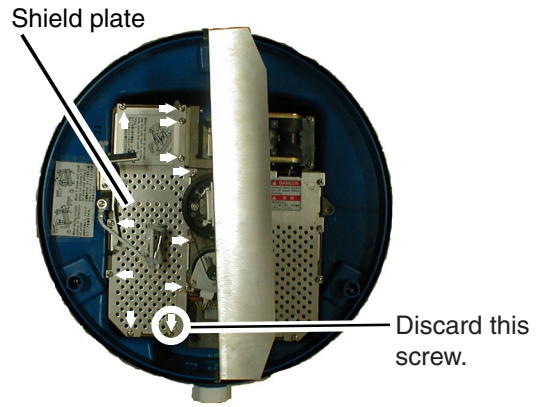

Antenna unit, cover removed, top view

- Pass the antenna cable with connector through the gasket and cable clamp, and then tighten cable gland. Two gaskets are supplied: one gray, one black. Use the proper gasket according to antenna cable used, referring to the illustration below.

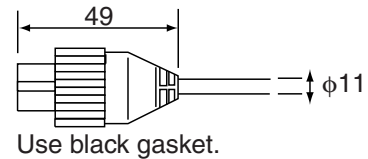
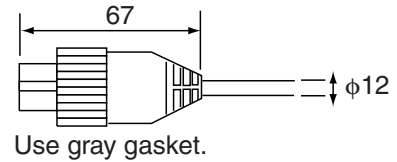
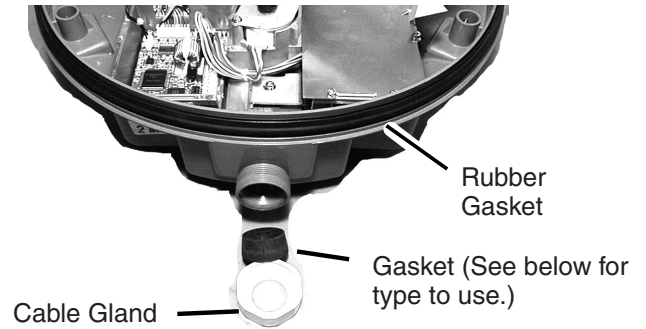

Antenna unit, top view



7. Referring to the figure below, fasten the shield cable with a screw (M4x10) on the chassis to ground the unit.

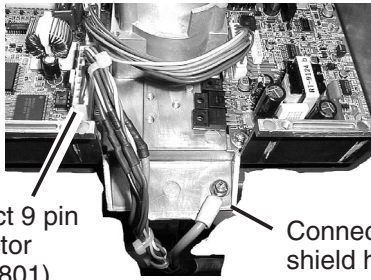

*How to connect the antenna cable to the antenna unit*

8. Attach the EMI core to the antenna cable. Set the EMI core fixing plate to the EMI core.

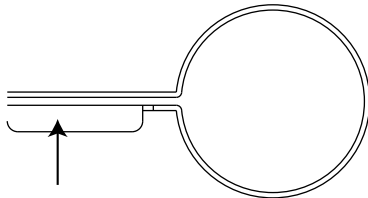

Pass the cable through the plate so the bend faces downward.

*EMI core fixing plate*

9. Connect the 9-pin connector of the antenna cable to J801. See the illustration above for location.
10. Refasten the shield plate with 10 screws. Be sure not to pinch the cable from the rotation detector with the shield plate.
11. Fasten the EMI core fixing plate with screw (supplied).

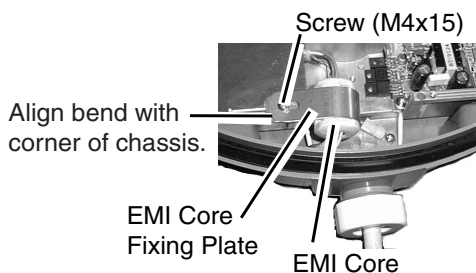

*How to fix the EMI core*

12. Close the cover. To fix the cover, push down on the cover evenly to close and then tighten cover fixing screws (3). Confirm that there is no more than 1 mm gap between the top cover and the antenna base.

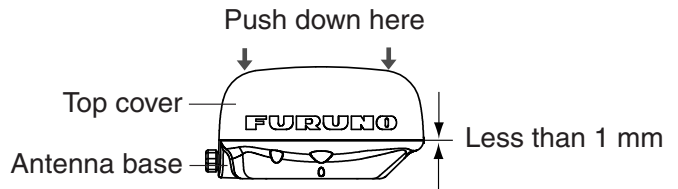

*How to fix the cover*

**Note:** If you need to measure magnetron voltage, temporarily fasten cover bolts so you can open the cover later.

**Mounting using the optional mounting bracket**

A mounting bracket for fastening the antenna unit to a mast (70-125 mm diameter) on a sailboat is optionally available (Type OP03-93, Code 008-445-080).

*Contents of mounting bracket kit*

Name	Type	Code No.	Qty
Bolt	M4x12	000-162-956-10	4
Bolt	M8x20	000-162-955-10	8
Mounting plate	03-018-9001-0	100-206-740	1
Support plate (1)	03-018-9005-0	100-206-780	1
Support plate (2)	03-018-9006-0	100-206-790	1
Bracket (1)	03-028-9101-0	100-206-810	1
Bracket (2)	03-028-9102-0	100-206-820	1
Fixing plate	03-028-9103-0	100-206-830	2

1. Remove mounting hardware at the bottom of the antenna base. You may discard the mounting hardware.
2. Assemble the mounting bracket as below and fasten it to a mast.
3. Fasten the antenna unit to the mounting bracket with hexagon head bolts (M10x25, optional supply).

### 3. INSTALLATION

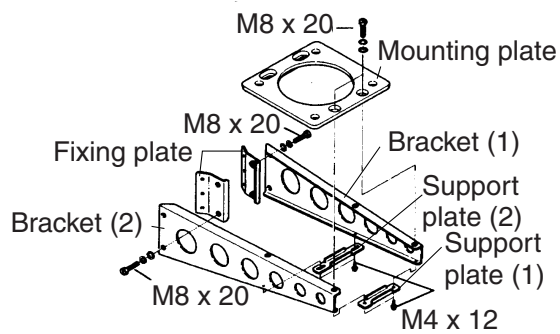

(A) Assembling the mounting bracket

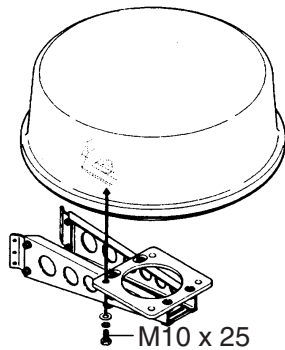

(B) Fastening antenna to mounting bracket

*How to assemble the optional mounting bracket and mount the antenna*

4. Unfasten three screws to open the cover.
5. Follow steps 5-12 in "Mounting on a platform."

## 3.2 Display Unit Installation

### Mounting considerations

When selecting a mounting location for the display unit keep in mind the following points:

- Keep the display unit out of direct sunlight.
- The temperature and humidity should be moderate and stable.
- Locate the unit away from exhaust pipes and vents.
- The mounting location should be well ventilated.
- Mount the unit where shock and vibration are minimal.
- Keep the unit away from electromagnetic field-generating equipment such as motors and generators.

- For maintenance and checking purposes, leave sufficient space at the sides and rear of the unit and leave slack in cables.
- Separate the display unit from a magnetic compass unit by the distances noted below to prevent interference to the magnetic compass:  
Standard compass: 0.5 m  
Steering compass: 0.3 m
- Be sure the mounting location is strong enough to support the weight of the unit under the continued vibration normally experienced on the boat.

### Mounting

The display unit can be mounted on a desktop or overhead or flush mounted in a console.

#### Desktop, overhead mounting

1. Fix the hanger to the mounting location with four tapping screws (supplied).
2. Fit the knob bolts to the display unit.
3. Set the display unit to the hanger.
4. Tighten the knob bolts securely.

#### Flush mounting

Cutout a hole in the mounting area referring to the outline drawing at the back of this manual. Fasten the display unit with four screws (M4 x 20, supplied).



### 3.3 Wiring

Connect the antenna cable, the power cable and the ground wire as shown below.

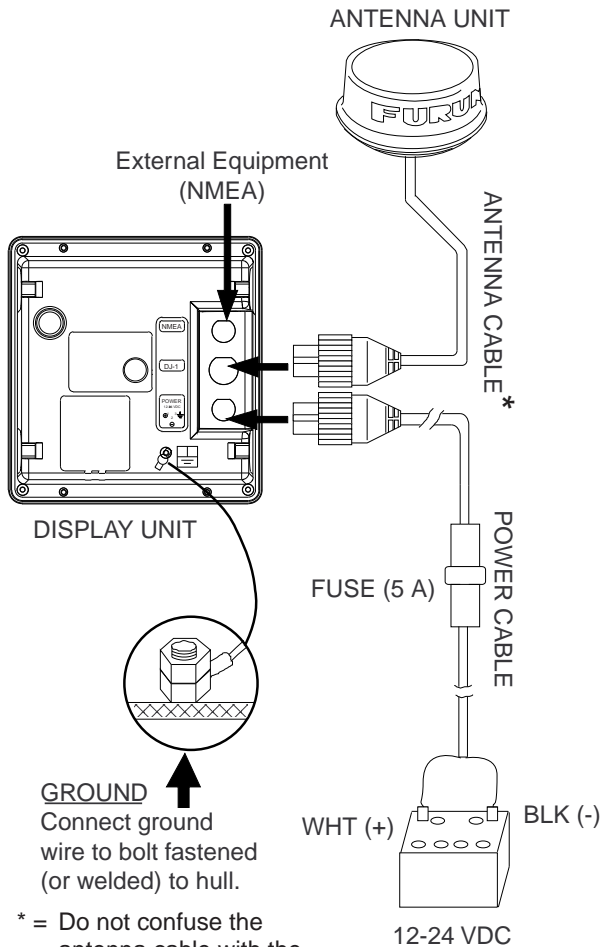

**GROUND**  
Connect ground wire to bolt fastened (or welded) to hull.

\* = Do not confuse the antenna cable with the transducer cable for the Echo Sounder LS-6100. The transducer cable is black; the antenna cable is white and "RADAR" is written on the cable.

#### Wiring

#### Connecting external equipment

A video sounder, navaid, wind indicator or GPS receiver GP-310(320B) can be connected to the display unit. You will need an NMEA cable to make the connection.

To connect two navigators, use the optional cable MJ-A15A7F0004-005. Connect them referring to the interconnection diagram at the back of this manual.

#### Input sentences

NMEA 0183 Version 1.5/2.0/3.0, 4800 bps

Name	Sentences
Ship's Speed	VTG>RMC>RMA>VBW>VHW
Depth	DPT>DBK>DBS>DBT
Heading (T)*	HDT>HDG>HDM
Heading (M)	HDM>HDG>HDT
Course (T)	RMC>RMA>VTG
Course (M)	VTG>RMA
Waypoint	RMB>BWR>BWC
Own Ship Pos.	GGA>RMC>RMA>GLL
Time Diff.	RMA>GLC>GTD
Water Temp.	MTW
Time	ZDA>RMC
Wind Data	MWV
Cross-track Error	XTE

\*Requires magnetic variation (output by navigator).

#### Output sentence

NMEA 0183 Version 3.0, 4800 bps

Name	Sentence
Target L/L	TLL

#### Connecting the external buzzer

The optional external buzzer (type XH3-BZ-L970, code no. 000-146-422) sounds the alarm buzzer in a remove location.

**Note:** This procedure requires making a hole in the display unit, which can affect watertightness. FURUNO cannot guarantee watertight integrity after this modification is made.

1. Detach the rear panel and place it out side up on a workbench.
2. Use a hammer and a Philips head screwdriver to punch out a hole of  $\varnothing 16$  at the location shown in the illustration at the top of the next page.

### 3. INSTALLATION

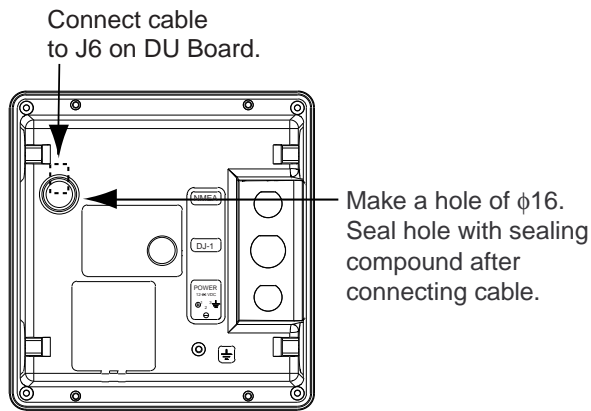

*Display unit, rear view*

3. Close the rear panel, making sure the gasket is correctly positioned.
4. Plug in the connector of the external buzzer to J6 on the DU Board.
5. Seal the hole with sealing compound.
6. Fix the buzzer to the location desired with two tapping screws.

### 3.4 Adjustments

After you have installed the radar, do the heading alignment and timing adjustment. If you are connecting external equipment, follow "NMEA port setup, GPS WAAS setup" (for GP-320B) also.

#### Heading alignment

You have mounted the antenna unit facing straight ahead in the direction of the bow. Therefore, a small but conspicuous target dead ahead visually should appear on the heading line (zero degrees).

In practice, you will probably observe some small error on the display because of the difficulty in achieving accurate initial positioning of the antenna unit. The following adjustment will compensate for this error.

1. Turn on the power while pressing and holding down the [MENU/ESC] key. Continue pressing the [MENU/ESC] key until the Installation menu appears.

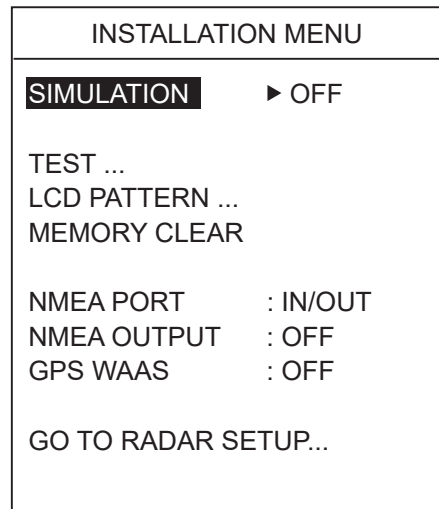

*Installation menu*

2. Press ▼ to choose GOTO RADAR SETUP.
3. Press ►. Power is then reset.
4. Wait one minute, press the [POWER/BRILL] key and then press the [MODE] key to transmit.
5. Press the [MENU/ESC] key to show the User menu.
6. Press ► to show the Radar Setup menu.

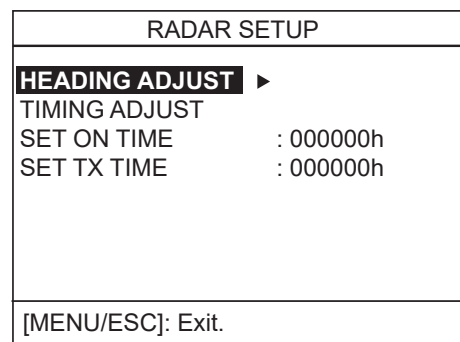

*Radar setup menu*

7. HEADING ADJUST is selected; press ► to show the options window.

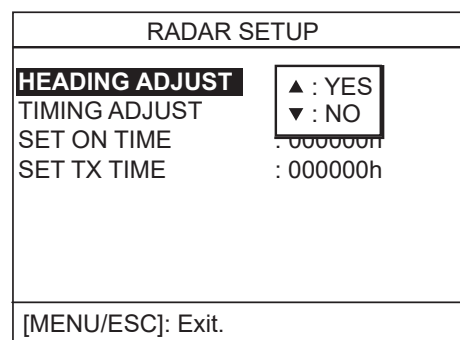

*Radar setup menu (heading adjust)*

- Press **▲** to select YES, and the display now looks as below.

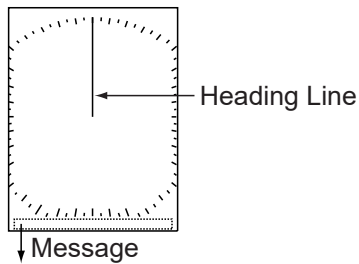

HEADING LINE ADJUSTMENT BY '←' AND '→' KEYS.  
THEN PUSH MODE KEY TO SET.

*Heading adjustment display*

- Visually identify a suitable target (for example, ship or buoy) at a range between 0.125 to 0.25 miles.
- Point your boat's bow directly toward the target selected at step 9.
- Locate the target selected at step 9 on the display and choose a range which places it in the outer half of the picture.
- Press **◀** or **▶** to bisect the target with the heading line.

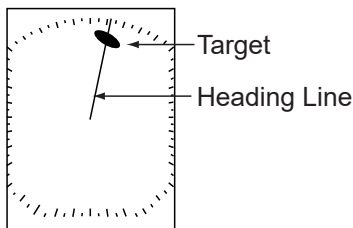

*Heading adjustment display*

- Press the [MODE] key.
- Press the [MENU/ESC] key to return to the installation menu.
- Move the boat towards a small buoy and confirm that the buoy shows up dead ahead on the radar when it is visually dead ahead.

**Timing adjustment**

Sweep timing differs with respect to the length of the antenna cable. Adjust sweep timing to prevent pushing or pulling of the target as illustrated below and placement of targets at incorrect ranges.

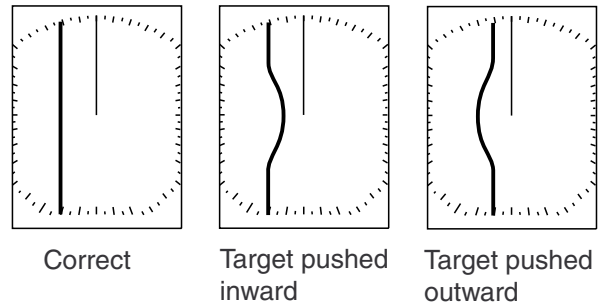

*Improper and correct sweep timing*

- Transmit on a range between 0.125 and 0.5 nm and adjust the sensitivity and A/C SEA. (See page 4 and 5 for procedure.)
- Select TIMING ADJUST from the Radar Setup menu and press **▶**.

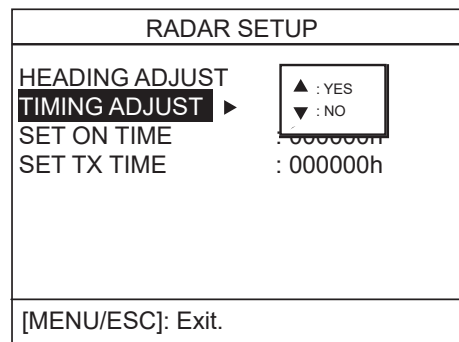

*Radar setup menu (timing adjust)*

- Press **▲** to choose YES, and the display now looks as below.

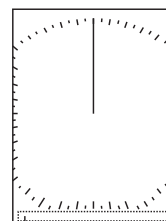

Message  
SWEEP TIMING ADJUSTMENT BY '▲' AND '▼' KEYS.  
THEN PUSH MODE KEY TO SET.

*Timing adjustment display*

- Find a target which should be "straight" (harbor wall, straight pier) on the radar display.
- While looking at the target selected at step 4, straighten it by pressing **▲** or **▼**.
- Press the [MODE] key.
- Press the [MENU/ESC] key to return to the installation menu to complete the procedure below, or shut off the power.

### 3. INSTALLATION

#### NMEA port setup, GPS WAAS setup

The NMEA port can function as an input port or input/output port.

If you are using the GP-320B, turn on the GPS WAAS feature.

1. Show the Installation menu and then press ▼ to choose NMEA PORT.
2. Press ► to display the NMEA port options window.
3. Press ▲ or ▼ to choose IN/OUT or IN/IN as appropriate.

**IN/OUT:** Input and Output (default setting). For GP-320B choose this setting.

**IN/IN:** Input only (Available with connection of multiple navigators.)

4. If you selected IN/OUT at step 3, press ◀, ▼ to choose NMEA OUTPUT, and then press ► to display the NMEA OUTPUT options window.
5. Press ▲ or ▼ to choose OFF or ON. Choose ON to output input data. Choose OFF to not output data or if the GP-310B or GP-320B is connected.
6. Press ◀ to close the window.
7. If the GP-320B is connected, press ▼ to choose GPS WAAS. Otherwise, go to step 10.
8. Press ► to open the window.
9. Press ▲ to choose message type.

**Note:** WAAS is currently in the developmental stage. While in the developmental stage choose message type 02. Change to message type 00 when WAAS becomes fully operational.

10. Turn off the power.

#### 3.5 Magnetron Heater Voltage

**Note:** This confirmation/adjustment should only be performed by a qualified service technician.

Magnetron heater voltage is formed at the MD Board of the antenna unit and preadjusted at the factory. Therefore, no

adjustment is required. However, verify heater voltage as below.

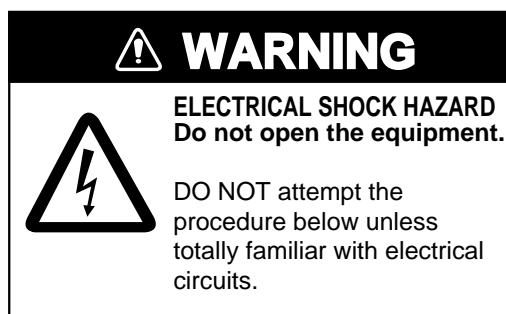

1. Open the antenna cover and remove the shield plate.

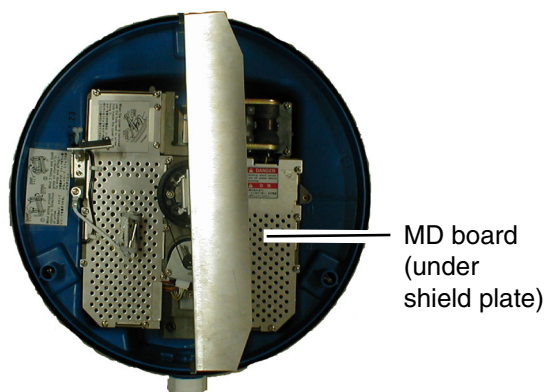

*Antenna unit, inside view*

2. Turn on the power. **DO NOT transmit.**
3. Connect a multimeter, set to 10 VDC range, between #6 (+) and #4 (-) of test point TP804.

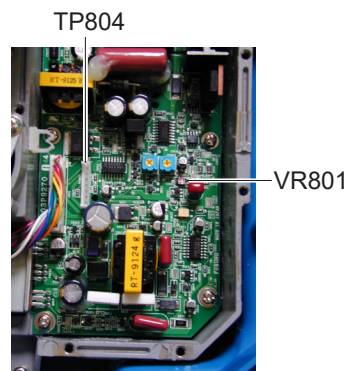



*MD board*

4. Confirm that the multimeter shows 8.0 V  $\pm 0.1$  V. If it does not, adjust potentiometer VR801 on the MD Board.
5. Turn off the power.
6. Refasten the shield plate.
7. Close the antenna cover.

# MENU TREE

MENU/ESC  
key

- TX/ST-BY (TX, **ST-BY**)
- INT REJECTION (OFF, **LOW**, MEDIUM, HIGH)
- ECHO STRETCH (**OFF**, LOW, HIGH)
- FTC (**OFF**, ON)
- NOISE REJECTION (OFF, **LOW**, HIGH)
- WATCHMAN TIME (**OFF**, 5, 10, 20 min)
- HDG LINE OFF (Temporarily turns off heading line.)
- ECHO TRAIL (**OFF**, 30 s; 1, 3, 6 min, CONTIN.)
- TRAIL BRILLIANCE (**LOW**, HIGH)
- SYSTEM MENU
  - LANGUAGE (**ENGLISH**, JAPANESE, Others)
  - RANGE UNIT (**nm**, km, sm)
  - DEPTH UNIT (**m**, ft, fa, HR, pb)
  - SPEED UNIT (**kt**, km/h, mph)
  - WIND UNIT (**kt**, km/h, mph, m/s)
  - TEMP UNIT (°C, °F)
  - NAV DATA (OFF, , , )
  - KEY BEEP (OFF, **ON**)
  - RINGS (OFF, **ON**)
  - WAYPOINT MARK (OFF, **ON**)
  - PANEL DIMMER (OFF, LOW, MEDIUM, **HIGH**)
  - HUE (**DAY**, NIGHT)
  - TRIPLOG RESET?
  - EBL REFERENCE (TRUE, **RELATIVE**)
  - BEARING READOUT (TRUE, **MAGNETIC**)
  - CURSOR POSITION (LAT/LON, **RNG&BRG**)
  - TRIP SOURCE (**LAT/LON**, SPEED)
  - WIND SPD/DIR (TRUE, **APPARENT**)
  - SHIFT MODE (**MANUAL**, AUTO)
  - AUTO SHIFT SPEED (1-99 (kts), **15**)
  - TX SECTOR BLANK (**OFF**, ON)
  - BLANKING START (000-359°, **000°**)
  - BLANKING AREA (000-135°, **000°**)
  - LOCAL TIME SETUP (-13:30 - +13:30, **0:00**)
  - ANTENNA SPEED (24rpm, **AUTO**)
  - RANGE
    - nm, sm: **0.125, 0.25, 0.5, 0.75, 1, 1.5, 2, 3, 4, 6, 8, 12, 16**
    - km: **0.25, 0.5, 0.75, 1, 1.5, 2, 3, 4, 6, 8, 12, 16, 24**

Turn on power

MENU/ESC  
key  
+  
POWER/BRILL  
key

- SIMULATION (**OFF**, ON, HIGH)
- TEST (Tests display unit.)
- LCD PATTERN (Displays test pattern.)
- MEMORY CLEAR (Restores default menu settings.)
- NMEA PORT (**IN/OUT**, IN/IN)
- NMEA OUTPUT (**OFF**, ON)
- GPS WAAS (**OFF**, WAAS 00-27)
- GO TO RADAR SETUP
  - RADAR SETUP
    - HEADING ADJUST (Adjusts heading.)
    - TIMING ADJUST (Adjusts timing.)
    - SET ON TIME (Displays total hours radar has been powered.)
    - SET TX TIME (Displays total hours of transmission.)
  - SCANNER TEST (Tests antenna unit.)

**SPECIFICATIONS OF MARINE RADAR  
MODEL 1623**

**1 GENERAL**

1.1 Indication system PPI Daylight display, raster scan, 4 tones in monochrome

1.2 Range, Pulselength (PL) & Pulse Repetition Rate (PRR)

Range (nm)	0.125, 0.25, 0.5, 0.75	1, 1.5, 2	3, 4, 6, 8, 12, 16
Pulse Length	0.08 μs (short)	0.3 μs (medium)	0.8 μs (long)
Pulse Repetition Rate	3000 Hz nominal	1200 Hz nominal	600 Hz nominal

1.3 Range resolution 16 m

1.4 Bearing discrimination 6.7°

1.5 Minimum range 22 m

1.6 Bearing accuracy Within 1°

1.7 Range ring accuracy 1.0 % of range or 8 m, whichever is the greater

**2 SCANNER UNIT**

2.1 Radiator Micro-strip

2.2 Polarization Horizontal

2.3 Antenna rotation speed 24/31/41 rpm nominal (auto-select according to range)

2.4 Radiator length 34 cm

2.5 Horizontal beamwidth Less than 6.2°

2.6 Vertical beamwidth 25°

2.7 Sidelobe attenuation Less than -20 dB

**3 TRANSCEIVER MODULE**

3.1 Frequency 9410 MHz ±30MHz (X band)

3.2 Modulation P0N

3.3 Peak output power 2.2 kW

3.4 Modulator FET Switching Method

3.5 Intermediate frequency 60 MHz

3.6 Tuning Automatic

3.7 Receiver front end MIC (Microwave IC)

3.8 Bandwidth 15 MHz (short pulse), 5 MHz (medium/long pulse)

3.9 Duplexer Circulator with diode limiter

3.10 Time of heat-up 1-min. approx.

**4 DISPLAY UNIT**

4.1 Screen 6" rectangular monochrome LCD

4.2 Display pixels 240(H) x 320(V) dots,  
Effective radar display area: 240x240 dots

4.3 Range, Range interval, Number of rings

Range (nm/km)	0.125	0.25	0.5	0.75	1	1.5	2	3	4	6	8	12	16	24
Ring interval	0.0625	0.125	0.125	0.25	0.25	0.5	0.5	1	1	2	2	3	4	6
Number of rings	2	2	4	3	4	3	4	3	4	3	4	4	4	4

Range unit: nm/sm/km selectable, 0.125: nm/sm only, 24: km only

- 4.4 Markers Heading Line, Bearing Scale, Range Rings, Variable Range Marker (VRM), Electronic Bearing Line (EBL), Tuning Bar, Cursor, Parallel Cursor, Alarm Zone, Waypoint Mark\*, North Mark\*
- 4.5 Alphanumeric indications Range, Range Ring Interval, Display Mode (HU), Interference Rejection (IR), Variable Range Marker (VRM), Electronic Bearing Line (EBL), Stand-by (ST-BY), Guard Alarm (G (IN), G (OUT), UP RANGE), Echo Stretch (ES), Range and Bearing to Cursor, Bearing or L/L Position, Echo Tailing (TRAIL), Trailing Time, Trailing Elapsed Time, Watchman (WATCHMAN), Zoomed Display (ZOOM), Navigation Data\*, Heading\* (HDC) \*: external data required
- 4.6 Input sentences IEC61162, NMEA0183 (Ver1.5/2.0) BWC, BWR, DBK, DBS, DBT, DPT, GGA, GLC, GLL, GTD, HDG, HDM, HDT, MTW, MWV, RMA, RMB, RMC, VBW, VHW, VTG, XTE, ZDA
- 4.7 Output sentences IEC61162, NMEA0183 (Ver3.0) TLL (by key operation)

## 5 ENVIRONMENTAL CONDITION

- 5.1 Ambient temperature
  - Scanner unit -25°C to +70°C
  - Display unit -15°C to +55°C
- 5.2 Relative humidity 95 % or less at +40°C
- 5.3 Degree of protection
  - Scanner unit IPX6
  - Display unit IPX5 (IPX0 when an external buzzer installed)
- 5.4 Vibration IEC60945

## 6 POWER SUPPLY

12-24 VDC: 3.5-1.6 A

## 7 COATING COLOR

- 7.1 Display unit N3.0
- 7.2 Scanner unit Cover: N9.5, Bottom: 2.5PB 3.5/10

## 8 COMPASS SAFE DISTANCE

- 8.1 Display unit Standard: 0.50 m Steering: 0.30 m
- 8.2 Scanner unit Standard: 1.25 m Steering: 0.95 m

# PACKING LIST

03GJ-X-9851 -20 1/1

MODEL1623-J-0/10/15/20, MODEL1623-E-0/10/15/20

A-1

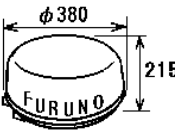
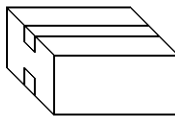
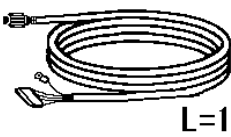
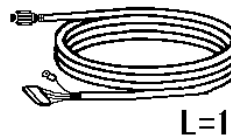
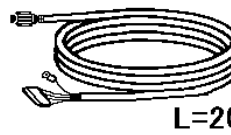
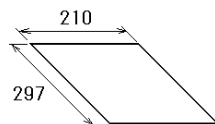
NAME	OUTLINE	DESCRIPTION/CODE No.	Q'TY
<b>ユニット UNIT</b>			
空中線部 ANTENNA UNIT		RSB-0093-074 000-020-401-00	1
指示部 DISPLAY UNIT		RDP-141-J/E 000-080-229-00 **	1
<b>空中線部工材 ANTENNA UNIT INSTALLATION MATERIALS</b>			
空中線部工材 INSTALLATION MATERIALS		CP03-25301 001-164-350-00	1
<b>工事材料 INSTALLATION MATERIALS</b>			
ケーブル組品MJ CABLE ASSEMBLY	 L=10M	MJ-A10SPF0003-100+ 001-122-790-10	1 (* )
ケーブル組品MJ CABLE ASSEMBLY	 L=15M	MJ-A10SPF0009-150+ 001-122-870-10	1 (* )
ケーブル組品MJ CABLE ASSEMBLY	 L=20M	MJ-A10SPF0009-200+ 001-122-880-10	1 (* )
<b>図書 DOCUMENT</b>			
技適認証要領 APPLICATION GUIDE		J32-02005-* 000-197-937-1*	1 (*1)

1.(\*)印のケーブル組品は、不用又は、10m,15m,20mの長さから選択できます。  
ASTERISK-MARKED SIGNAL AVAILABLE IN 10M, 15M OR 20M LENGTH.

2.コード番号末尾の[\*\*]は、選択部品の代表コード番号を表します。  
CODE NUMBER ENDED BY "\*\*" INDICATES THE NUMBER OF TYPICAL MATERIAL.

3.(\*1)の書類は、和文仕様専用  
(\*1) MARKED DOCUMENTS ARE FOR JAPANESE SET ONLY.

(略図の寸法は、参考値です。 DIMENSIONS IN DRAWING FOR REFERENCE ONLY.)



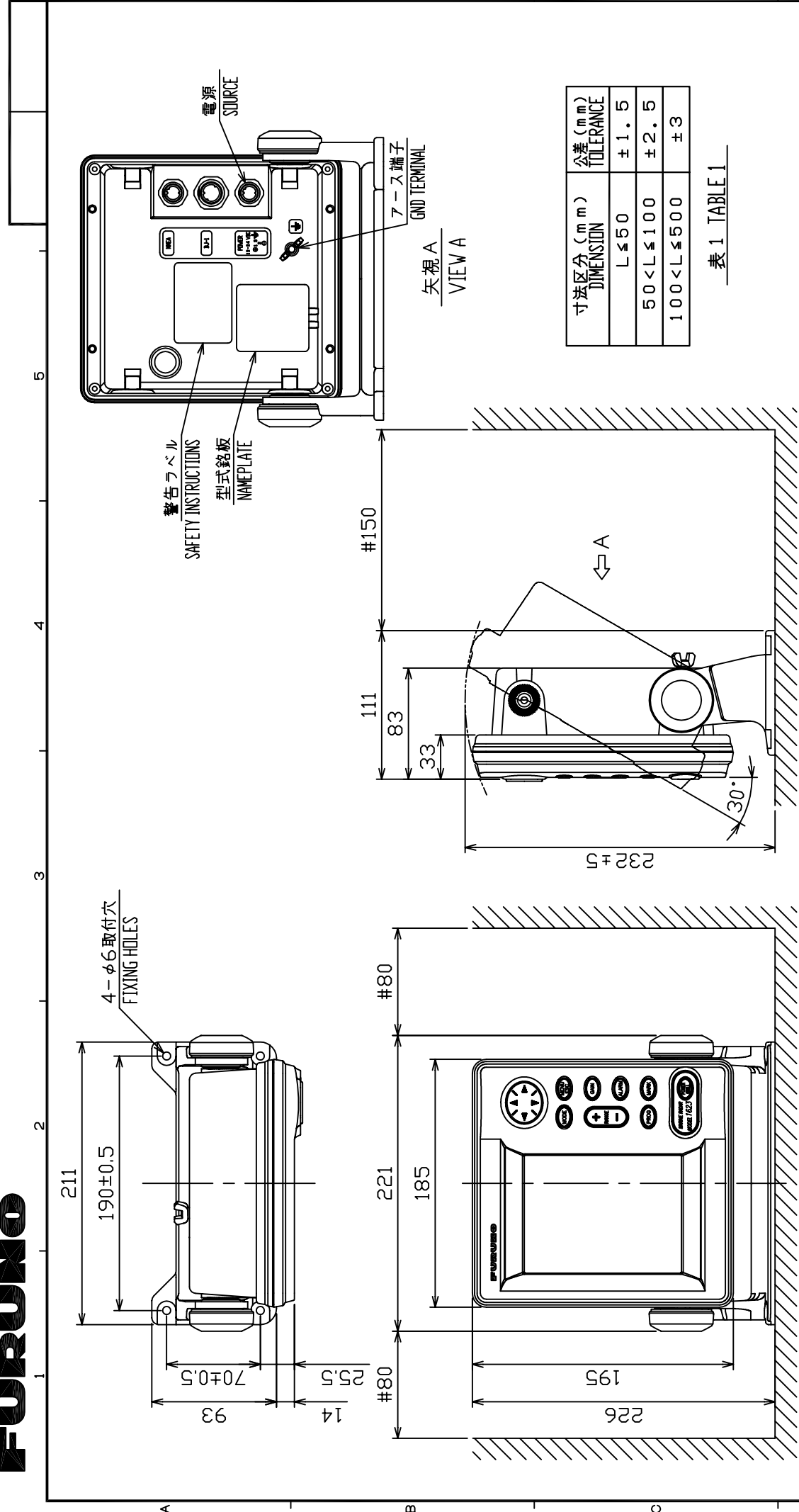

- 注 記 1) #印寸法は最小サービスクリアランスとする。  
 2) 指定外の寸法公差は表 1 による。  
 3) 取付用ネジはトラスタップピングネジ呼び径 5 × 2.0 を使用のこと。
- NOTE 1. #: RECOMMENDED SERVICE CLEARANCE.  
 2. TABLE 1 INDICATES TOLERANCE OF DIMENSIONS.  
 3. USE TAPPING SCREWS 5 × 2.0 FOR FIXING THE UNIT.

DRAWN	Oct. 2 '02	T. YAMASAKI	TITLE	RDP-141
CHECKED	Oct. 2 '02	Y. KIMURA	名称	指示部 (卓上装備)
APPROVED	Oct. 2 '02	Y. Kamezono	外寸図	
SCALE	1/4	MASS 1.3 ±10% kg	MODEL	1623
DWG. No.	C3510-G01-A	03-160-100G-2	質量は付属カバーを含まず。 MASS WITH ACCESSORY COVER.	DISPLAY UNIT (DESKTOP MOUNT)
				OUTLINE DRAWING

寸法区分 (mm) DIMENSIONS	公差 (mm) TOLERANCE
$L \leq 50$	$\pm 1.5$
$50 < L \leq 100$	$\pm 2.5$
$100 < L \leq 500$	$\pm 3$

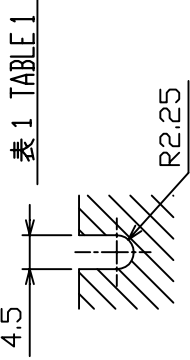

取付ネジ部断面 (尺度 1/1)  
DETAIL OF FASTENING (SCALE: 1/1)

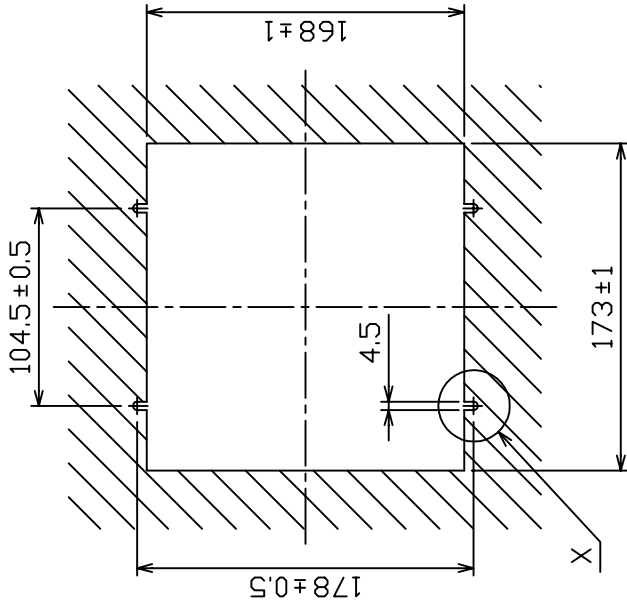

取付穴寸法図  
CUTOUT DIMENSIONS

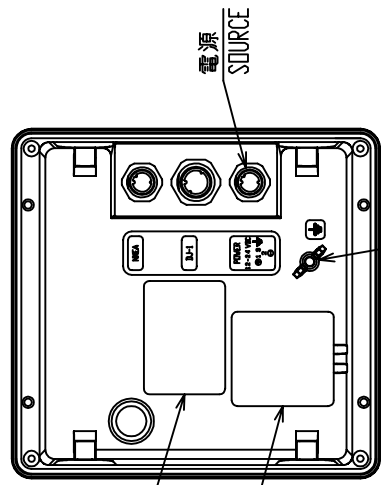

背面 REAR

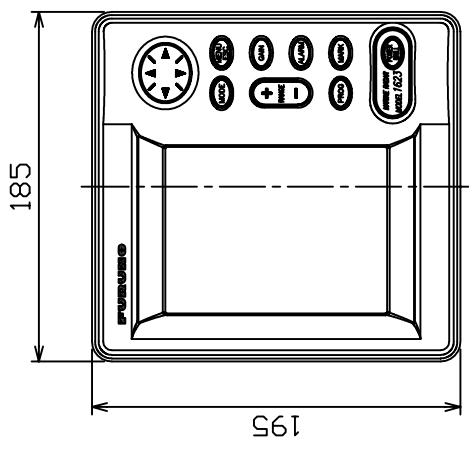
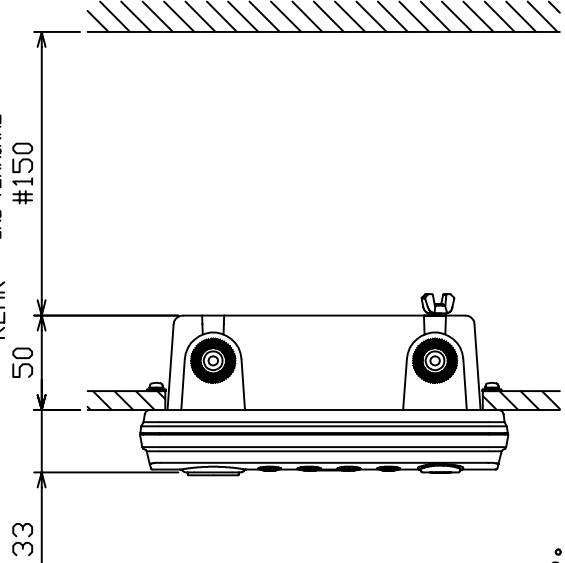

- 注 記 1) 井印寸法は最小サービースペース寸法とする。  
 2) 指定外の寸法公差は表 1 による。  
 3) 取付用ネジは、セムスネジ B M4 x 2.0 を使用のこと。  
 壁の厚さ (A) は  $11 \leq A \leq 14$  とする。それ以外の壁に  
 装着する場合は、使用するネジ長さは  $(A + 7.8) \pm 2$  とする。  
 筐体にはネジ部 (B) を 8 mm 以上入れないこと。  
 # RECOMMENDED SERVICE CLEARANCE.  
 TABLE 1 INDICATES TOLERANCE OF DIMENSIONS.  
 USE M4x2.0 SCREWS FOR FIXING THE UNIT.  
 THICKNESS A:  $11 \leq A \leq 14$  OR SCREW LENGTH:  $(A + 7.8) \pm 2$ .  
 DO NOT FASTEN SCREWS INTO UNIT MORE THAN 8 mm (B ≤ 8)

DRAWN	Oct. 2 '02	T. YAMASAKI	TITLE	RDP-141
CHECKED	Oct. 2 '02	Y. KITAJIMA	名称	指示部 (埋込装置)
APPROVED	Oct. 2 '02	Y. KAWADA	外寸図	
SCALE	1/4	MASS 1.1 ±10% kg	MODEL	1623
DATE	C3510-G02-A		質量は付属カバーを含まず。 MASS WITH ACCESSORY COVER.	
			03-160-110G-2	OUTLINE DRAWING

表 1 TABLE 1

寸法区分 (mm) DIMENSIONS	公差 (mm) TOLERANCE
$L \leq 50$	$\pm 1.5$
$50 < L \leq 100$	$\pm 2.5$
$100 < L \leq 500$	$\pm 3$

- 注 記 1) 指定外の寸法公差は表 1 による。  
 2) 取付用ネジは M10 ボルトを使用のこと  
 ネジ長さは板厚  $t$  に応じて、 $20 (t \leq 5)$  または  $25 (5 < t \leq 10)$  とする
- NOTE 1. TABLE 1 INDICATES TOLERANCE OF DIMENSIONS WHICH IS NOT SPECIFIED.  
 2. USE M10 BOLTS FOR FIXING THE UNIT.  
 BOLT LENGTH SHALL BE ACCORDING TO PLATFORM THICKNESS "t":  $20 (t \leq 5)$  OR  $25 (5 < t \leq 10)$ .

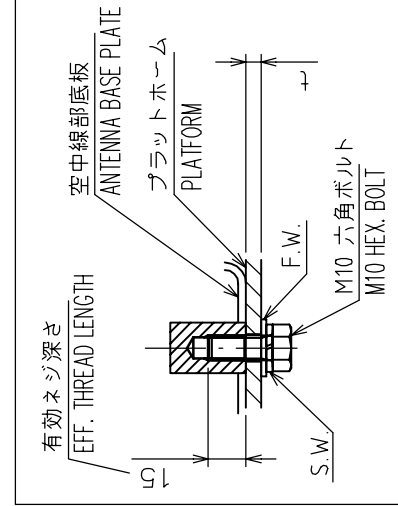
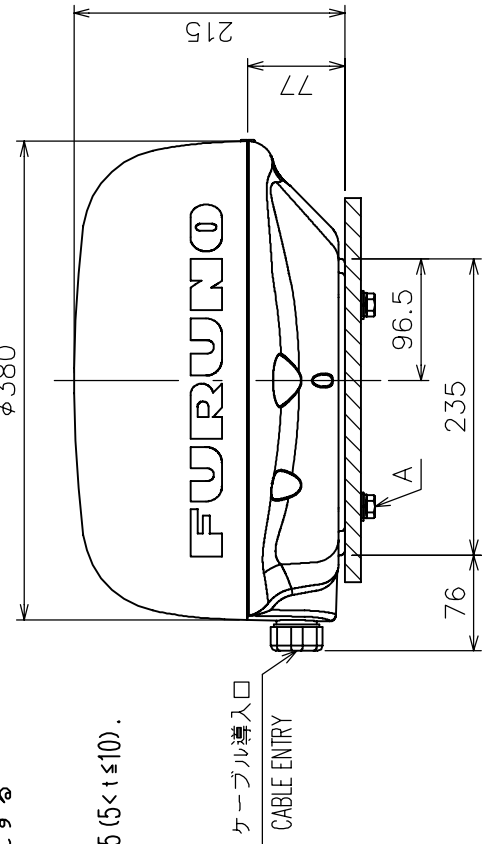
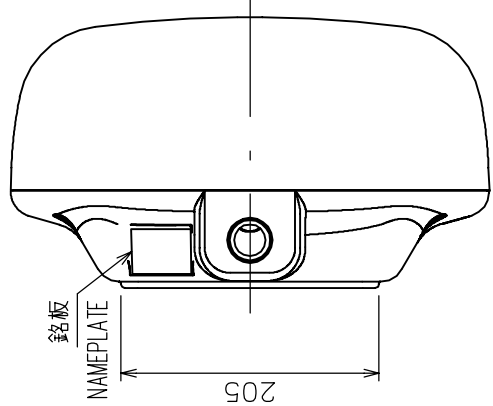
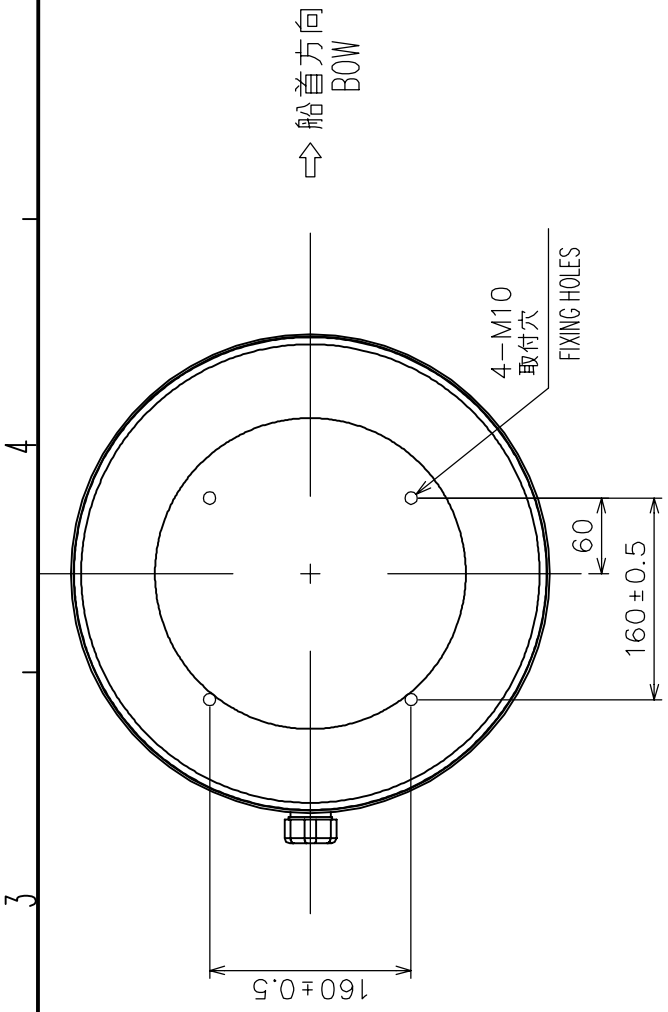

DRAWN	Nov. 18, '04	E. MIYOSHI	TITLE	RSB-0093
CHECKED		TAKAHASHI, T	名称	空中線部
APPROVED		Y. Hatai	外寸図	
SCALE	1/6	MASS 4.6 kg	NAME	ANTENNA UNIT
DWG.No.	C3510-G03-A	MODEL 1623		OUTLINE DRAWING

A 部 詳細 (尺度 1/3)  
 DETAIL A (SCALE 1/3)

4

3

2

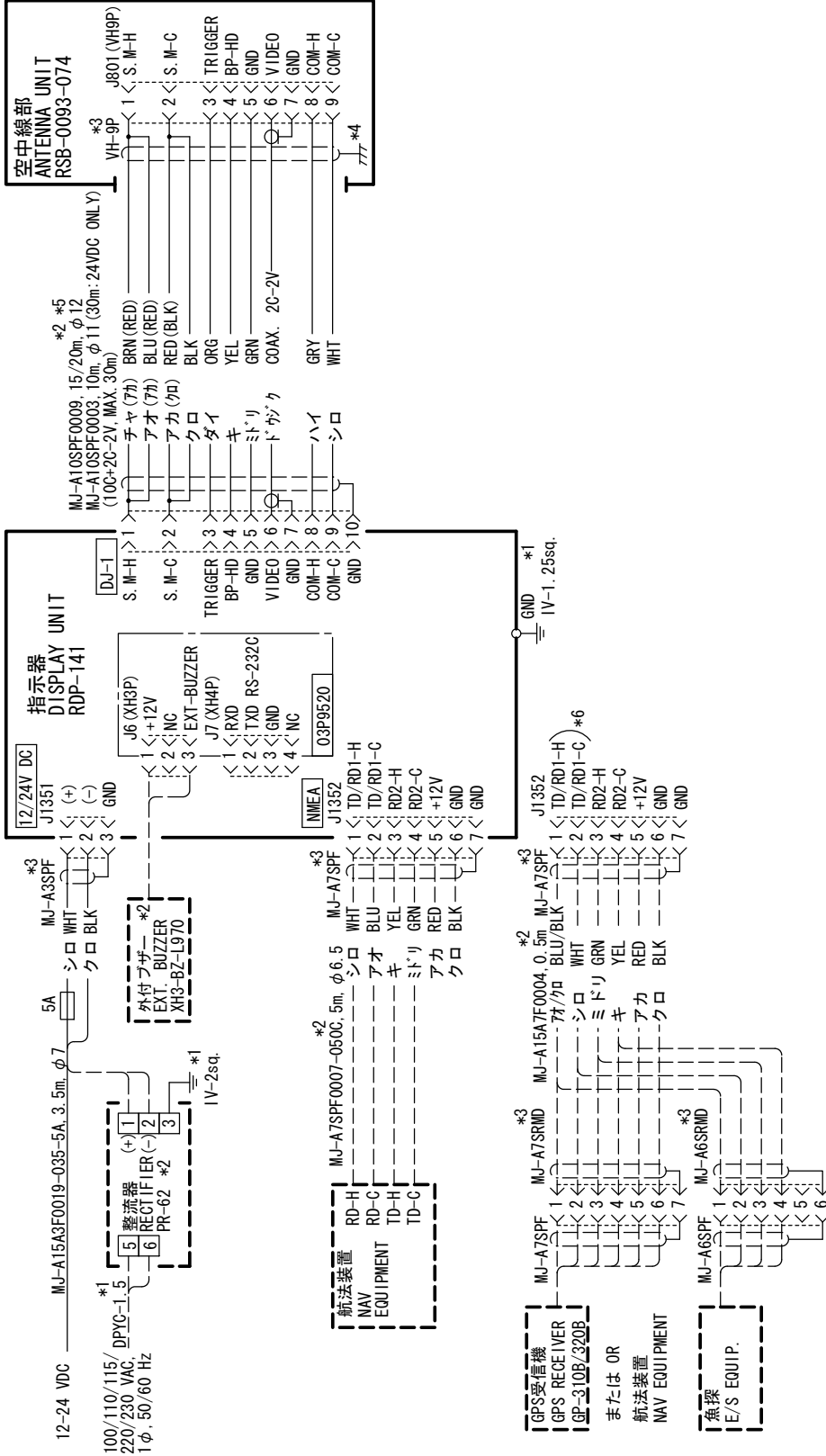

**注記**

- \*1) 造船所手配。
- \*2) オプション。
- \*3) 工場にて取付済み。
- \*4) 空中線部のシールドは完全にアースする。
- \*5) ( ): MJ-A10SPF0009の芯線色を示す。
- \*6) MJ-A15A7F0004使用時は、メニューでRDを選択。

**NOTE**

- \*1: SHIPYARD SUPPLY.
- \*2: OPTION.
- \*3: FITTED AT FACTORY.
- \*4: GROUND EFFECTIVELY AT SCANNER UNIT.
- \*5: ( ): WIRE COLOR OF MJ-A10SPF0009.
- \*6: SELECT RD FROM MENU WHEN MJ-A15A7F0004 CABLE IS USED.

DRAWN	15/Feb/2011	I. YAMASAKI	TITLE	MODEL 1623
CHECKED	15/Feb/2011	H. MAKI	名称	船舶用レーダー
APPROVED	16/Feb/2011	Y.NISHIYAMA		相互結線図
SCALE	1/MASS	kg	NAME	MARINE RADAR
DWG. No.	C3510-C01-E	REF. No.	03-160-6001-0	INTERCONNECTION DIAGRAM

# FURUNO Worldwide Warranty for Pleasure Boats (Except North America)

This warranty is valid for products manufactured by Furuno Electric Co. (hereafter FURUNO) and installed on a pleasure boat. Any web based purchases that are imported into other countries by anyone other than a FURUNO certified dealer may not comply with local standards. FURUNO strongly recommends against importing these products from international websites as the imported product may not work correctly and may interfere with other electronic devices. The imported product may also be in breach of the local laws and mandated technical requirements. Products imported into other countries as described previously shall not be eligible for local warranty service.

For products purchased outside of your country please contact the national distributor of Furuno products in the country where purchased.

This warranty is in addition to the customer's statutory legal rights.

## 1. Terms and Conditions of Warranty

FURUNO guarantees that each new FURUNO product is the result of quality materials and workmanship. The warranty is valid for a period of 2 years (24 months) from the date of the invoice, or the date of commissioning of the product by the installing certified dealer.

## 2. FURUNO Standard Warranty

The FURUNO standard warranty covers spare parts and labour costs associated with a warranty claim, provided that the product is returned to a FURUNO national distributor by prepaid carrier.

The FURUNO standard warranty includes:

- Repair at a FURUNO national distributor
- All spare parts for the repair
- Cost for economical shipment to customer

## 3. FURUNO Onboard Warranty

If the product was installed/commissioned and registered by a certified FURUNO dealer, the customer has the right to the onboard warranty.

The FURUNO onboard warranty includes

- Free shipping of the necessary parts
- Labour: Normal working hours only
- Travel time: Up to a maximum of two (2) hours
- Travel distance: Up to a maximum of one hundred and sixty (160) KM by car for the complete journey

## 4. Warranty Registration

For the Standard Warranty - presentation of product with serial number (8 digits serial number, 1234-5678) is sufficient. Otherwise, the invoice with serial number, name and stamp of the dealer and date of purchase is shown.

For the Onboard Warranty your FURUNO certified dealer will take care of all registrations.

## 5. Warranty Claims

For the Standard Warranty - simply send the defective product together with the invoice to a FURUNO national distributor. For the Onboard Warranty – contact a FURUNO national distributor or a certified dealer. Give the product's serial number and describe the problem as accurately as possible.

Warranty repairs carried out by companies/persons other than a FURUNO national distributor or a certified dealer is not covered by this warranty.

## 6. Warranty Limitations

When a claim is made, FURUNO has a right to choose whether to repair the product or replace it.

The FURUNO warranty is only valid if the product was correctly installed and used. Therefore, it is necessary for the customer to comply with the instructions in the handbook. Problems which result from not complying with the instruction manual are not covered by the warranty.

FURUNO is not liable for any damage caused to the vessel by using a FURUNO product.

The following are excluded from this warranty:

- a. Second-hand product
- b. Underwater unit such as transducer and hull unit
- c. Routine maintenance, alignment and calibration services.
- d. Replacement of consumable parts such as fuses, lamps, recording papers, drive belts, cables, protective covers and batteries.
- e. Magnetron and MIC with more than 1000 transmitting hours or older than 12 months, whichever comes first.
- f. Costs associated with the replacement of a transducer (e.g. Crane, docking or diver etc.).
- g. Sea trial, test and evaluation or other demonstrations.
- h. Products repaired or altered by anyone other than the FURUNO national distributor or an authorized dealer.
- i. Products on which the serial number is altered, defaced or removed.
- j. Problems resulting from an accident, negligence, misuse, improper installation, vandalism or water penetration.
- k. Damage resulting from a force majeure or other natural catastrophe or calamity.
- l. Damage from shipping or transit.
- m. Software updates, except when deemed necessary and warrantable by FURUNO.
- n. Overtime, extra labour outside of normal hours such as weekend/holiday, and travel costs above the 160 KM allowance
- o. Operator familiarization and orientation.

FURUNO Electric Company, March 1, 2011

## FURUNO Warranty for North America

FURUNO U.S.A., Limited Warranty provides a twenty-four (24) months LABOR and twenty-four (24) months PARTS warranty on products from the date of installation or purchase by the original owner. Products or components that are represented as being waterproof are guaranteed to be waterproof only for, and within the limits, of the warranty period stated above. The warranty start date may not exceed eighteen (18) months from the original date of purchase by dealer from Furuno USA and applies to new equipment installed and operated in accordance with Furuno USA's published instructions.

Magnetrons and Microwave devices will be warranted for a period of 12 months from date of original equipment installation.

Furuno U.S.A., Inc. warrants each new product to be of sound material and workmanship and through its authorized dealer will exchange any parts proven to be defective in material or workmanship under normal use at no charge for a period of 24 months from the date of installation or purchase.

Furuno U.S.A., Inc., through an authorized Furuno dealer will provide labor at no cost to replace defective parts, exclusive of routine maintenance or normal adjustments, for a period of 24 months from installation date provided the work is done by Furuno U.S.A., Inc. or an AUTHORIZED Furuno dealer during normal shop hours and within a radius of 50 miles of the shop location.

A suitable proof of purchase showing date of purchase, or installation certification must be available to Furuno U.S.A., Inc., or its authorized dealer at the time of request for warranty service.

This warranty is valid for installation of products manufactured by Furuno Electric Co. (hereafter FURUNO). Any purchases from brick and mortar or web-based resellers that are imported into other countries by anyone other than a FURUNO certified dealer, agent or subsidiary may not comply with local standards. FURUNO strongly recommends against importing these products from international websites or other resellers, as the imported product may not work correctly and may interfere with other electronic devices. The imported product may also be in breach of the local laws and mandated technical requirements. Products imported into other countries, as described previously, shall not be eligible for local warranty service.

For products purchased outside of your country please contact the national distributor of Furuno products in the country where purchased.

### WARRANTY REGISTRATION AND INFORMATION

To register your product for warranty, as well as see the complete warranty guidelines and limitations, please visit [www.furunousa.com](http://www.furunousa.com) and click on "Support". In order to expedite repairs, warranty service on Furuno equipment is provided through its authorized dealer network. If this is not possible or practical, please contact Furuno U.S.A., Inc. to arrange warranty service.

FURUNO U.S.A., INC.  
**Attention: Service Coordinator**  
4400 N.W. Pacific Rim Boulevard  
Camas, WA 98607-9408  
Telephone: (360) 834-9300  
FAX: (360) 834-9400

Furuno U.S.A., Inc. is proud to supply you with the highest quality in Marine Electronics. We know you had several choices when making your selection of equipment, and from everyone at Furuno we thank you. Furuno takes great pride in customer service.

# Declaration of Conformity

## [MODEL 1623]

Bulgarian (BG)	<p>С настоящото Furuno Electric Co., Ltd. декларира, че гореспоменат тип радиосъоръжение е в съответствие с Директива 2014/53/ЕС. Цялостният текст на ЕС декларацията за съответствие може да се намери на следния интернет адрес:</p>
Spanish (ES)	<p>Por la presente, Furuno Electric Co., Ltd. declara que el tipo de equipo radioeléctrico arriba mencionado es conforme con la Directiva 2014/53/UE. El texto completo de la declaración UE de conformidad está disponible en la dirección Internet siguiente:</p>
Czech (CS)	<p>Tímto Furuno Electric Co., Ltd. prohlašuje, že výše zmíněné typ rádiového zařízení je v souladu se směrnicí 2014/53/EU. Úplné znění EU prohlášení o shodě je k dispozici na této internetové adrese:</p>
Danish (DA)	<p>Hermed erklærer Furuno Electric Co., Ltd., at ovennævnte radioudstyr er i overensstemmelse med direktiv 2014/53/EU. EU-overensstemmelseserklæringens fulde tekst kan findes på følgende internetadresse:</p>
German (DE)	<p>Hiermit erkläre die Furuno Electric Co., Ltd., dass der oben genannte Funkanlagentyp der Richtlinie 2014/53/EU entspricht. Der vollständige Text der EU-Konformitätserklärung ist unter der folgenden Internetadresse verfügbar:</p>
Estonian (ET)	<p>Käesolevaga deklareerib Furuno Electric Co., Ltd., et ülalmainitud raadioseadme tüüp vastab direktiivi 2014/53/EL nõuetele. ELi vastavusdeklaratsiooni täielik tekst on kättesaadav järgmisel internetiaadressil:</p>
Greek (EL)	<p>Με την παρούσα η Furuno Electric Co., Ltd., δηλώνει ότι ο προαναφερθέντας ραδιοεξοπλισμός πληροί την οδηγία 2014/53/ΕΕ. Το πλήρες κείμενο της δήλωσης συμμόρφωσης ΕΕ διατίθεται στην ακόλουθη ιστοσελίδα στο διαδίκτυο:</p>
English (EN)	<p>Hereby, Furuno Electric Co., Ltd. declares that the above-mentioned radio equipment type is in compliance with Directive 2014/53/EU. The full text of the EU declaration of conformity is available at the following internet address:</p>
French (FR)	<p>Le soussigné, Furuno Electric Co., Ltd., déclare que l'équipement radioélectrique du type mentionné ci-dessus est conforme à la directive 2014/53/UE. Le texte complet de la déclaration UE de conformité est disponible à l'adresse internet suivante:</p>
Croatian (HR)	<p>Furuno Electric Co., Ltd. ovime izjavljuje da je gore rečeno radijska oprema tipa u skladu s Direktivom 2014/53/EU. Cjeloviti tekst EU izjave o sukladnosti dostupan je na sljedećoj internetskoj adresi:</p>
Italian (IT)	<p>Il fabbricante, Furuno Electric Co., Ltd., dichiara che il tipo di apparecchiatura radio menzionato sopra è conforme alla direttiva 2014/53/UE. Il testo completo della dichiarazione di conformità UE è disponibile al seguente indirizzo Internet:</p>
Latvian (LV)	<p>Ar šo Furuno Electric Co., Ltd. deklarē, ka augstāk minēts radioiekārta atbilst Direktīvai 2014/53/ES. Pilns ES atbilstības deklarācijas teksts ir pieejams šādā interneta vietnē:</p>

- Lithuanian (LT) Aš, Furuno Electric Co., Ltd., patvirtinu, kad pirmiau minėta radijo įrenginių tipas atitinka Direktyvą 2014/53/ES.  
Visas ES atitikties deklaracijos tekstas prieinamas šiuo interneto adresu:
- Hungarian (HU) Furuno Electric Co., Ltd. igazolja, hogy fent említett típusú rádióberendezés megfelel a 2014/53/EU irányelvnek.  
Az EU-megfelelőségi nyilatkozat teljes szövege elérhető a következő internetes címen:
- Maltese (MT) B'dan, Furuno Electric Co., Ltd., niddikjara li msemmija hawn fuq-tip ta' tagħmir tar-radju huwa konformi mad-Direttiva 2014/53/UE.  
It-test kollu tad-dikjarazzjoni ta' konformità tal-UE huwa disponibbli f'dan l-indirizz tal-Internet li ġej:
- Dutch (NL) Hierbij verklaar ik, Furuno Electric Co., Ltd., dat het hierboven genoemde type radioapparaat conform is met Richtlijn 2014/53/EU.  
De volledige tekst van de EU-conformiteitsverklaring kan worden geraadpleegd op het volgende internetadres:
- Polish (PL) Furuno Electric Co., Ltd. niniejszym oświadczam, że wyżej wymieniony typ urządzenia radiowego jest zgodny z dyrektywą 2014/53/UE.  
Pełny tekst deklaracji zgodności UE jest dostępny pod następującym adresem internetowym:
- Portuguese (PT) O(a) abaixo assinado(a) Furuno Electric Co., Ltd. declara que o mencionado acima tipo de equipamento de rádio está em conformidade com a Diretiva 2014/53/UE.  
O texto integral da declaração de conformidade está disponível no seguinte endereço de Internet:
- Romanian (RO) Prin prezenta, Furuno Electric Co., Ltd. declară că menționat mai sus tipul de echipamente radio este în conformitate cu Directiva 2014/53/UE.  
Textul integral al declarației UE de conformitate este disponibil la următoarea adresă internet:
- Slovak (SK) Furuno Electric Co., Ltd. týmto vyhlasuje, že vyššie spomínané rádiové zariadenie typu je v súlade so smernicou 2014/53/EÚ.  
Úplné EÚ vyhlásenie o zhode je k dispozícii na tejto internetovej adrese:
- Slovenian (SL) Furuno Electric Co., Ltd. potrjuje, da je zgoraj omenjeno tip radijske opreme skladen z Direktivo 2014/53/EU.  
Celotno besedilo izjave EU o skladnosti je na voljo na naslednjem spletnem naslovu:
- Finnish (FI) Furuno Electric Co., Ltd. vakuuttaa, että yllä mainittu radiolaitetyyppi on direktiivin 2014/53/EU mukainen.  
EU-vaatimustenmukaisuusvakuutuksen täysimittainen teksti on saatavilla seuraavassa internetosoitteessa:
- Swedish (SV) Härmed försäkrar Furuno Electric Co., Ltd. att ovan nämnda typ av radioutrustning överensstämmer med direktiv 2014/53/EU.  
Den fullständiga texten till EU-försäkran om överensstämmelse finns på följande webbadress:

## Online Resource

[http://www.furuno.com/en/support/red\\_doc](http://www.furuno.com/en/support/red_doc)









**ECF**

(Elemental Chlorine Free)

The paper used in this manual  
is elemental chlorine free.

**FURUNO ELECTRIC CO., LTD.**

9-52 Ashihara-cho,  
Nishinomiya, 662-8580, JAPAN

• FURUNO Authorized Distributor/Dealer

All rights reserved. Printed in Japan

Pub. No. OME-35100-J

(REFU ) MODEL1623

A : OCT. 2002

J : JUN. 30, 2022



0 0 0 1 9 7 6 7 7 1 1